

FUJIFILM MEDICAL SYSTEMS PRODUCT PROFILES

Changing the worldwide medical scene with a stream of innovative products.



Innovative technology from Fujifilm is changing the medical scene all over the world.

Having pioneered the world's first digital X-ray system, the Fuji Computed Radiography (FCR), in 1983, Fujifilm has maintained its focus on building technological innovations and has been continuously offering new solutions to the medical field. We have gained recognition from medical institutions of all practices and to date*1 have sold over 70,000 digital imaging systems worldwide.

Our product line consists of the following: FDR, FCR, DRYPIX, SYNAPSE, and Film/Screen Systems.

First, we would like to introduce our Fujifilm Digital Radiography (FDR) line of products of which the FDR AcSelerate stands at the pinnacle. This product uses the revolutionary Direct Conversion hardware technology on its Flat Panel Detector and the Image Intelligence™ software technology in its Console Advance making it the DR product of the future. Another FDR product is our AMULET which is a unit specifically designed for mammography.

Next, we would like to introduce our compact FCR line of products which are best suited for those of you who have space restrictions or for those who want to use space more effectively. They include the PRIMA Series which are compact systems for small-volume X-ray facilities, the mobile FCR Go system, and the CAPSULA Series which are all-round units. Of the CAPSULA Series, the CAPSULA XLII is a system characterized in high processing capacity and 50-micron reading for mammography.

As for our console products, there is our Console Advance which can control multiple FCR and FDR devices from this unit alone. And, there is our FCRView whose interface and operability have been improved. Combining the capacity of an image viewer with operational and data administration capabilities, the FCRView and the PRIMA Console are the ultimate all-in-one workstations that give you functionality from X-ray taking to archiving of data.

Then, there is our DRYPIX series of dry imagers. Through technologies only available at Fujifilm, we can provide high-quality images to any medical institution on the globe at the fastest speed.

And, there is our SYNAPSE, an image and information management system which is installed in approximately 2,800*2 medical institutions worldwide. This number alone is a proof of its technological capability. This technology is now being applied to cardiology.

Last but not least, there is our Film/Screen Systems line of products.

Having gained our position as a leading company in medical imaging systems, we are totally committed to bringing about change to the medical field through our philosophy "Innovative Products through Continuous Progress."

*1. As of end of September 2009 *2. As of end of December 2009

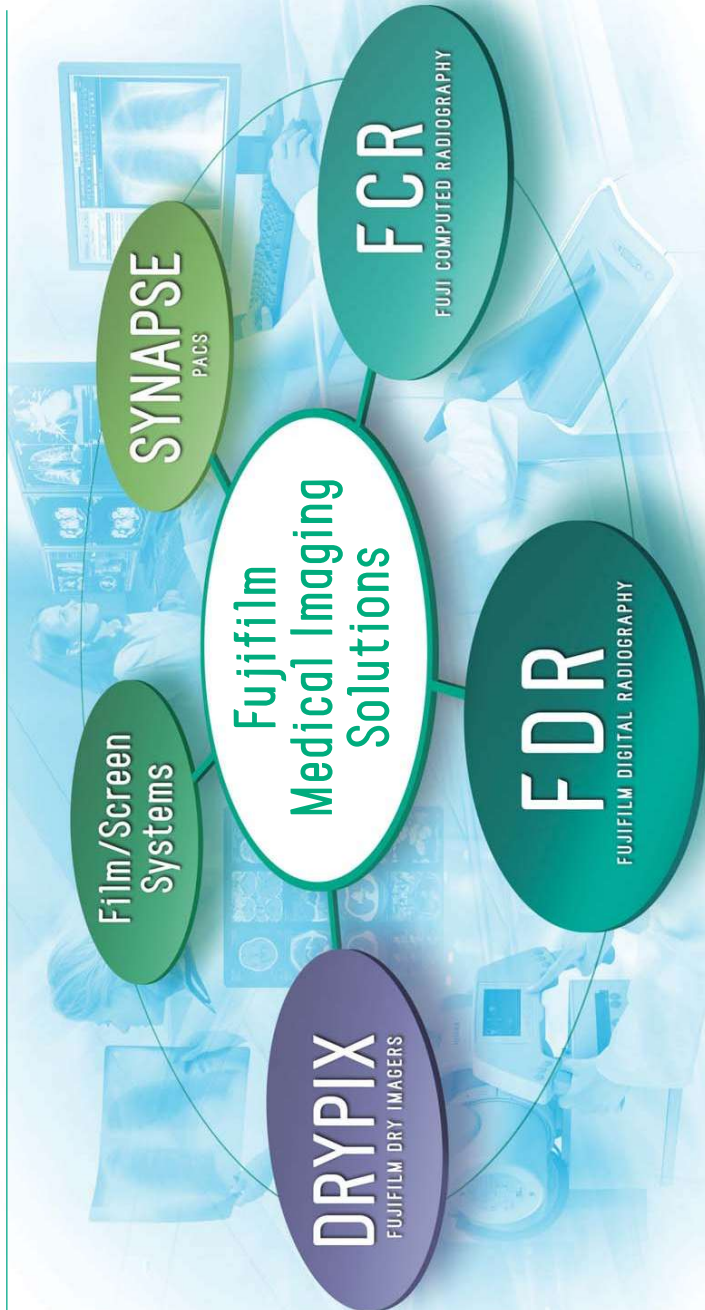

Image Intelligence™ also contributes to the field of medical imaging, presenting only necessary information to the doctor.

Fujifilm helps to provide an efficient and precise diagnostic procedure by analyzing the image from an X-ray with techniques such as contrast and density automatic adjustment which enable parts of an image that were difficult to be seen to be displayed more clearly.

MFP Multi-Frequency Processing

Enhances FCR images. All diagnostic scopes will be enhanced except for noise.

FNC Flexible Noise Control

Provides a non-grainy image by mainly isolating and suppressing the noise in the signal.

GPR Grid Pattern Removal

Removes the stationary grid patterns thus preventing Moiré from being generated resulting in easier diagnosis.

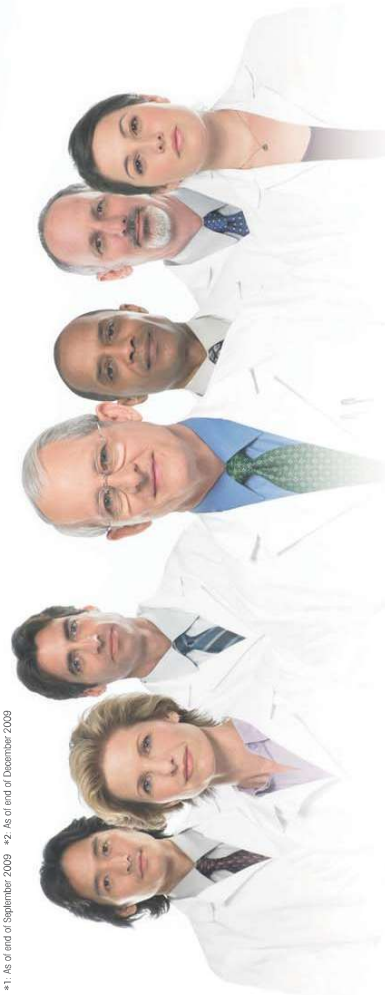

FDR AcSelerate

The new pinnacle in diagnostic imaging and a total solution for the entire X-ray room



The FDR AcSelerate is the newest addition to our Fujifilm Digital Radiography (FDR) line of products. Building on our longstanding digital expertise and superior diagnostic image processing technology, we have developed the new Flat Panel Detector (FPD) which offers a remarkably high X-ray conversion characteristic. This FPD together with an innovative and easy-to-use X-ray unit form the AcSelerate product line. The FDR AcSelerate was created for you, our customer, so that we at Fujifilm can continue to demonstrate our strong commitment to diagnostic imaging for years to come.

Advanced Diagnostic Applications

Ergonomic Design and Good Workflow

- Fully motorized system
- Wide travel range

Superior Image Quality

- High DQE/MTF Direct Conversion (Image Intelligence[®])
- Image processing (Image Intelligence[®])

FDR AcSelerate NEW

Image Quality

Direct Conversion FPD — the revolutionary flat panel from Fujifilm

Our newly developed direct conversion FPD is at the heart of AcSelerate, providing high conversion efficiency. It allows more effective use of the X-ray energy and offers high-quality images with enhanced MTF and DQE, but with reduced radiation dose. Lifespan and temperature control limitations, seen on traditional flat panels, have been greatly improved and our FPD offers superb durability while utilising a simple air-cooling system.

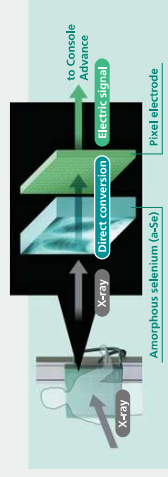

Enhanced diagnostic value with a wide dynamic range and high resolution

Our FPD provides 150 micron resolution with image quality unequalled by other systems. With its 16 bit dynamic range, even minimal X-ray absorption differences are clearly depicted within exams of target body parts such as the chest, and the bones and soft tissues in orthopedic exams.



Operability

Console Advance -flexible for FDRs and FCRs

The Console Advance features the same functionality and intuitiveness as the CR Console, making it easy for existing FCR users to adopt the Console Advance and work efficiently. If both FDR and FCR systems are being used in the same department, images from both systems can be combined at the Console Advance, simplifying the workflow.

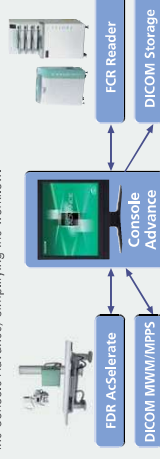

Fastest processing speed of its kind!

With AcSelerate things are quick in the X-ray room. The preview image is available on the Console Advance screen in only 2 seconds*, allowing quick review of the image. Additionally, cycle time between exposures is approximately 4 seconds*, allowing the technologist to work with speed and efficiency and making the process smoother for the patient.



Wide range of movement for various examinations

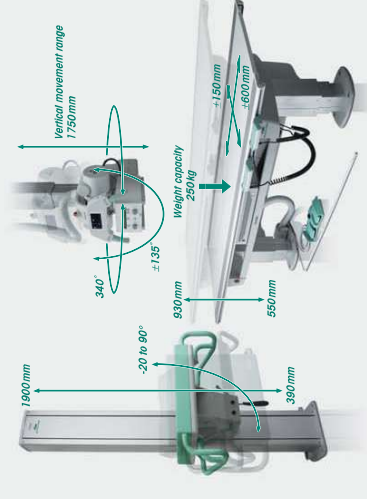

Increasing efficiency with auto-positioning

By selecting the program from the exposure menu on the Console Advance, the X-ray tube automatically moves to the required position using the 5-axis motorized tube support. Manual adjustments can always be applied, however, the simplicity and accuracy of AcSelerate make manual movements a thing of the past!

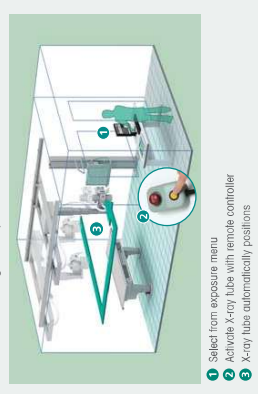

* All products require regulatory approval of the importing country. For details on product availability, contact our local representative.

FCR PRIMA Series

We, the pioneer company that introduced digital diagnosis to the world of analog X-ray diagnosis, proudly present the new compact digital X-ray image processing unit of the FCR PRIMA Series. This product has been highly acclaimed by clinics and hospitals worldwide due to its durability of hardware and competency of after services. Because of its small size, this unit can be installed in any small office or clinic and still produce high-quality images equivalent to those of larger units.

FUJI COMPUTED RADIOGRAPHY
PRIMA Series
 NEW

Taking the first step to our digital world

From digitalize to output, this is Fujifilm's seamless workflow

DIGITALIZE

- ▶ A compact and lightweight reading unit with a footprint of only 0.24 m²
- ▶ Fujifilm's Image Intelligence™ technology automatically enables stable and optimized high-quality images
- ▶ Flexible reading of images in various sizes from regular exam to pantomography
- ▶ Throughput of up to 29 images an hour



READ / ARCHIVE

- ▶ Image processing and viewing, and data archiving all done on one workstation
- ▶ Advanced image processing enables accurate diagnosis with simple operation
- ▶ Various diagnostic functions such as magnifying, measuring, and annotating
- ▶ Integrated management of image and patient data of up to 200,000 patients
- ▶ Copying of image data to a DVD or NAS (Network Attached Storage) as backup, requiring less storage space.
- ▶ Distribution of image data to patients using the PDI (Portable Data for Imaging) function



OUTPUT

- ▶ A compact and lightweight tabletop laser imager with a footprint of only 0.39 m²
- ▶ Five film sizes can be loaded to meet diagnostic purposes
- ▶ No need for a liquid disposal facility, a clean and user-friendly dry processing
- ▶ Free Layout Print enables you to lay out different studies on one film and print it out
- ▶ Speedy output of up to 70 films an hour

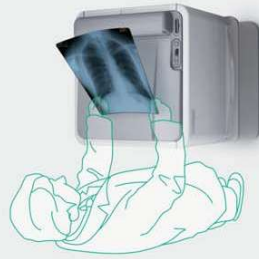

FCR PRIMA Console / FCR PRIMA V Console

The FCR PRIMA Console is an image management workstation with easy-to-use menus that guide your operation from image taking to diagnosis. (The FCR PRIMA V Console is for veterinary use.)



FCR PRIMA

This image reader is best suited for use in clinics and small hospitals because of its simple and compact design. Yet, it is equipped with a state-of-the-art image processing function.



DRYPIX PRIMA

This tabletop laser imager offers high-contrast and high-resolution images and helps to improve the accuracy of your diagnosis.

Series Lineup

* All products require regulatory approval of the importing country. For details on product availability, contact our local representative.

FDR

Unparalleled image quality in digital radiology

FUJIFILM DIGITAL RADIOGRAPHY

FUJIFILM DR has adopted Focused Phosphor Technology in the imaging detector, attaining twice the DQE (Detective Quantum Efficiency) of non-FDR equipment systems and allowing reduced exposure dose but with higher image quality. And with Fujifilm's proprietary Image Intelligence™ technology, the contrast and density of images are automatically adjusted to provide only the required information to the doctor's hands.

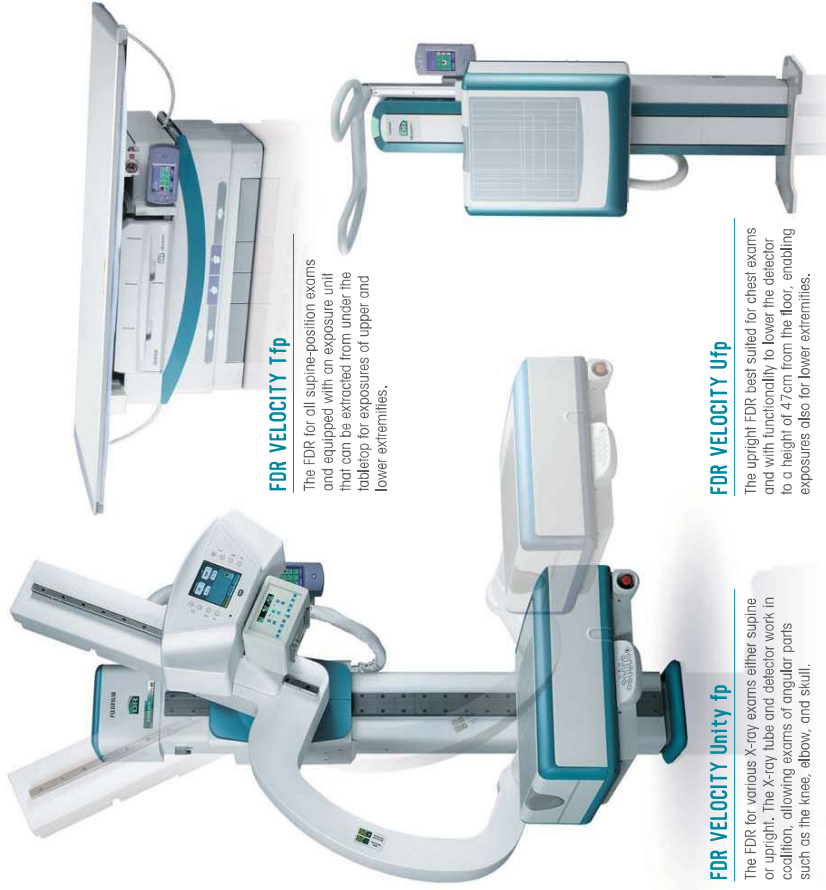

FDR VELOCITY Tfp

The FDR for all supine-position exams and equipped with an exposure unit that can be extracted from under the tabletop for exposures of upper and lower extremities.

FDR VELOCITY Ufp

The upright FDR best suited for chest exams and with functionality to lower the detector to a height of 47cm from the floor, enabling exposures also for lower extremities.

FDR VELOCITY Unity fp

The FDR for various X-ray exams either supine or upright. The X-ray tube and detector work in condition, allowing exams of angular parts such as the knee, elbow, and skull.

Focused Phosphor Plate

Standard Imaging Plate

Focused Phosphor Technology

Focused Phosphor Technology applies an even thicker Focused Phosphor Plate now with the phosphor particles in a columnar structure which allows the stimulation light to penetrate deep into the phosphor layer and extract the Photo Stimulated Luminescence (PSL) that is generated through the surface of the Focused Phosphor Plate. As a result, both X-ray exposure efficiency and image quality have been enhanced.

Phosphor
Aluminum

• All products require regulatory approval of the importing country. For details on product availability, contact our local representative.

FCR GO

FCR Go gathers smiles everywhere - anytime, anyplace

The FCR Go offers you the capacity to make X-ray exposures and preview images quickly and accurately just about everywhere. Whether it's at the bedside, in the operating room, or within the intensive care unit, FCR Go lessens the inconveniences often experienced in making the rounds. This system truly enhances work efficiency by responding to the diversifying needs of hospitals.



Mobility as you like it

The duct motor drive allows free and smooth steering, with speed adjustment capability, and gives superb mobility even in tight spaces. Designed to be silent, you can comfortably move the unit at night time. A touch sensor is situated on the front of the unit, stopping the machine automatically when an obstacle is touched.

Positioning as you need it

The telescopic arm adjusts easily to the precise desired position. The arm also has extended horizontal and vertical travel letting you use longer exposure distances for high-quality images. The X-ray tube also moves both horizontally and vertically, allowing desired positioning even when the arm is in a diagonal position.

Lightweight cassettes make you smile

The rugged, lightweight IP (Imaging Plate) cassettes, available in a variety of sizes, add to the precise positioning you need to deliver high performance in areas with limited space such as at the bedside. Various size IPs and cassettes fill a variety of studies.



• All products require regulatory approval of the importing country. For details on product availability, contact our local representative.

FCR

Pioneered over 25 years ago and still leading the way

FUJI COMPUTED RADIOGRAPHY

FCR has remained the leader in the field for more than 25 years. FCR is a premium digital X-ray solution, offering the broadest product line to suit the requirements of nearly every imaging application. FCR's leadership position is driven by uncompromised image quality, continued investment in technology innovation, development of systems with the highest productivity, and system implementation through the most experienced group of Professional Service individuals in the industry. FCR is the best possible solution for transition to digital at both large and small facilities.

NEW



FCR PRIMA

This product is one of the most compact and lightweight image readers on the market. Yet, it is equipped with a state-of-the-art image processing function.



FCR CAPSULA X

High-quality and compact FCR for a broad range of diagnostic imaging. Small enough to fit almost anywhere – footprint 0.22 m².



FCR CAPSULA XLII

Equipped with state-of-the-art functions including an optional 50-micron reading kit for Mammography applications.*1

DSR Dual-Side Reading Technology

Increases DQE (Detective Quantum Efficiency) by collecting the emissions from both sides of the IP with optimal, spatial frequency-dependent factors.

FDA Fujifilm Computed Radiography (FCR), the world's first CR that has acquired PMA**2 approval from FDA**3 for mammography.



FCR XG5000

A high-efficiency FCR reader that offers quality imaging and all-round versatility for superior diagnostic capability.



FCR PROTECT ONE4**

High-resolution one-stacker FCR with 20 pixel/mm sampling pitch for digital mammography and pediatric imaging.



FCR PROTECT CS4**

Superior image quality with 20 pixel/mm sampling pitch mammography and pediatric imaging with four-cassette stacker.

*1 Not available in the US and Canada. In other countries, follow local regulations/guidelines
 **2 PMA (Premised Approval) **3 FDA (U.S. Food and Drug Administration)
 **4 Image reader for Mammography

Imaging Plate and Cassette

IP ST-VI
 FCR Imaging Plate for general purposes.



- 14" x 17" (35.4 x 43.2 cm)
- 14" x 14" (35.4 x 35.4 cm)
- 10" x 12" (25.7 x 30.5 cm)
- 8" x 10" (20.3 x 25.4 cm)

IP HR-V
 FCR Imaging Plate for single-sided mammography reading.



- 24 x 30 cm
- 18 x 24 cm

IP Cassette Type CC
 FCR standard cassette with or without lead foil backside.



- 14" x 17" (35.4 x 43.2 cm)
- 14" x 14" (35.4 x 35.4 cm)
- 10" x 12" (25.7 x 30.5 cm)
- 8" x 10" (20.3 x 25.4 cm)
- 15 x 30 cm

IP Cassette Type CH
 FCR special cassette for IP HR-V reading.



- 24 x 30 cm
- 18 x 24 cm

IP Cassette Type LC
 FCR long view cassette for Scoliosis

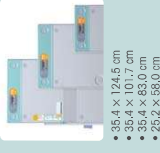

- 35.4 x 124.5 cm
- 35.4 x 101.7 cm
- 35.4 x 83.0 cm
- 25.2 x 88.0 cm
- 24.0 x 57.0 cm

FCR VELOCITY U

Ideally suited for chest imaging with advanced scanning and image processing capabilities; features include the HD LINESCAN Technology.



FCR VELOCITY T

Proven FCR technology for supine examinations with advanced scanning and image processing capabilities; features include the HD LINESCAN Technology.



* All products require regulatory approval of the importing country. For details on product availability, contact our local representative.

Mammography Solutions



AMULET FUJIFILM DIGITAL MAMMOGRAPHY SYSTEM

Fujifilm's revolutionary digital mammography system, AMULET, is equipped with a new type direct-conversion flat panel detector (FPD) that boasts the world's smallest pixel size*1 of 50µm and also simultaneously realizes both high-resolution and low-noise images through a Fujifilm developed panel structure with a dual layer of amorphous selenium, and the world's first*2 Direct Optical Switching Technology. Indications of masses and microcalcifications are clearly depicted with super high resolution, and even workflow time has been shortened by approximately 15 seconds for the waiting intervals from one exposure shot to the next. And the woman-friendly ergonomic design of the system unit greatly reduces the stress and discomfort experienced with mammography exams.

*1 *2: Based on publicly available and disclosed information concerning amorphous selenium direct-conversion digital mammography as of October, 2006. (Fujifilm study)

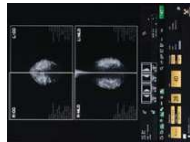

AWS (Acquisition Workstation)

- A console specifically designed for mammography, providing enhanced efficiency in line with the workflow with its functions and operational screens.
- Upright screen monitor
- Really distinguishable X-ray controls in a computer display
- Sequence 1, 2, or 4 images on a single monitor
- Locally works!
- View monitor code sequence, pixel peaking value, etc.
- Option of Fujifilm's Mammography QC Program
- Precise Enlargement Function on Optional Detailed Display Screen



The innovative selenium panel developed exclusively by Fujifilm

The 50µm flat panel offers exceptional performance and provides optimum image quality

Direct Optical Switching Technology – New from Fujifilm

The X-ray sensor employs a direct switching method and the panel is comprised of a dual layer of amorphous selenium. By extracting the image signal that is converted to an electric charge through the newly-developed Direct Optical Switching system rather than a conventional TFT switch, Fujifilm has reduced electronic noise and achieved a pixel pitch of 50µm.

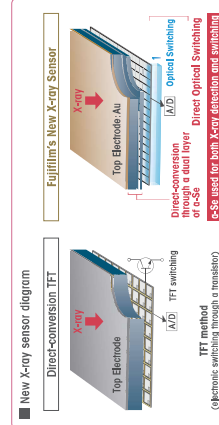

Fujifilm's exclusive amorphous selenium (a-Se) panel

Through the use of our device development technology and vacuum deposition technology, we have produced a highly-pure amorphous selenium, offering a higher X-ray conversion rate. In addition, the shorter time required to erase the residual electric charge, through high-intensity light, made possible by the use of Direct Optical Switching Technology, shortens the imaging cycle and improves the efficiency.

Higher image quality achieved using our proven FCR imaging technology

AMULET uses the mammography image processing technology from our proven FCR system. It provides high quality images that enhance visualization of the mammary tissue and offers greater detail of abnormal areas. Thus, AMULET will certainly help improve your diagnostic efficiency.

* In the U.S. and CANADA, the AMULET cannot be applicable to mammography. In other countries, the locally applicable regulations and/or guidelines should be followed.

Fujifilm CR Digital Mammography Systems

Bringing high quality with economy and reliability



Using advanced technologies to assist early detection of breast cancer, Fujifilm's easy-to-use digital systems, the FCR PROTECT CS and PROTECT ONE, expedite workflow with multi-room capability, background image processing, and automatic image routing features. Touch-panel accessibility and intuitive software enable the CR Console to facilitate data confirmation and networking versatility. Linking the FCR reader via the CR Console to the CAD Mammography Workstation greatly expands image reading capacity. In addition, the AWS-c can also be connected to PROTECT CS or ONE as an Acquisition Workstation. Fujifilm's Digital Mammography Systems benefit operator and patient alike by providing more information from a single acquisition, thereby ensuring a more accurate diagnosis.

FDA
Fujifilm Computed Radiography (CR), the world's first CR that has acquired PMA* approval from FDA* for mammography.

Fujifilm supports the Pink Ribbon campaign for early detection of breast cancer

Image Reader for Mammography

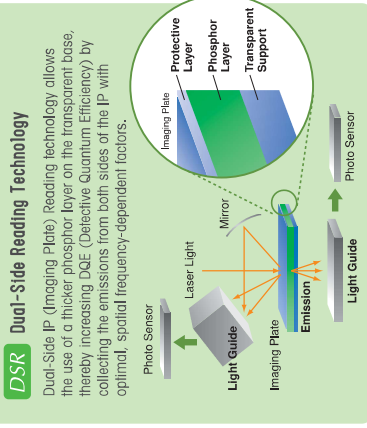

*3: Not available in the US and Canada. In other countries, follow local regulations/guidelines.

Fujifilm CAD (Computer-Aided Detection)



Fujifilm Digital Mammography CAD is a valuable detection support system. Using proprietary algorithms, this CAD system helps detect areas on the breast image that may indicate cancer with the readily distinguishable CAD marks.

Mammography QC Program



Fujifilm's Mammography QC Program is a dedicated quality control program applicable to FUJIFILM digital mammography systems. This program enables the system to keep a stable image quality for both screening and diagnosis.

* All products require regulatory approval of the importing country. For details on product availability, contact our local representative.

DRYPIX

High quality images with high diagnostic value to the hands of the doctor

FUJIFILM DRY IMAGERS

Fujifilm Dry Imagers mark a revolutionary breakthrough in dry imaging. They all provide extraordinary imaging capabilities, from clear and precise images with high diagnostic value, to advanced image networking potential. From small clinics to radiology departments in busy general hospitals, there's a Fujifilm DRYPIX imager exactly suited to every workload requirement.

DRYPIX PRIMA

The DRYPIX PRIMA is a lightweight tabletop laser imager with a footprint of only 0.39m². This compact imager is able to output films in five different sizes with only one film tray, and has a Free Layout Print which enables you to lay out different studies on one film and print it out.

NEW

DRYPIX 4000

The DRYPIX 4000 combines proven reliability and convenience with remarkable operating efficiency, all in a compact body. Boasting unrivalled image quality, networkability, backup security, and accessible price, DRYPIX 4000 is the ideal imager for medium-sized hospitals.



DRYPIX 7000

The remarkably efficient DRYPIX 7000 is designed as a centralized imager with a maximum of three film sizes. It has a built-in DICOM print server, enabling easy connection with all DICOM modalities through the network. An optional 10-bin film sorter provides added workflow efficiency.

DRYPIX 2000

DRYPIX 2000 is a compact and efficient tabletop dry imager. It supports multiple film sizes and is expandable to two magazines. The DRYPIX 2000 is an optimal choice for small clinical settings or as a part of a dispersed system in large hospitals.

ECO-DRY System

DRYPIX's ECO-DRY system is environmentally friendly, from films to processing. DRYPIX medical films employ unique aqueous solvents that are free from unpleasant odors and create neutral colored images so crisp, they're indistinguishable from those printed on wet halide film. Additional ECO-DRY advantages include our development of new liquid-coating technology, which minimizes the need for harmful organic solvents like methyl-ethyl-ketone and toluene in the thermal development of light-sensitive materials.

Dry Laser Imaging System (DRYPIX PRIMA/4000/7000)

DRYPIX 4000/7000's Dry Laser Imaging System uses a photo-thermographic process, which combines laser exposure and thermal development. Following exposure to an ultra-precise laser, the photo-sensitive film is then uniformly heated using unique Fujifilm thermal element technology. Operating costs and efficiency benefit from the elimination of wet chemicals and their environmental implications.

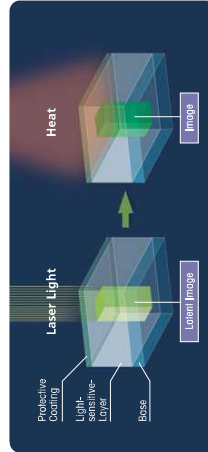

DURATHERM™ Imaging System (DRYPIX 2000)

Fujifilm's innovative DURATHERM™ technology ensures stable, artifact-free printing performance and extended thermal-head life. Using Fujifilm's patented micro-isolating thermal film, DRYPIX 2000 produces the unexcelled image quality you have come to expect from DRYPIX imagers.

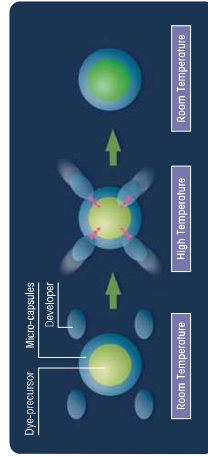

DRYPIX support features

A variety of advanced features and technologies support the DRYPIX series, ensuring images of optimal quality as well as superb connectivity for ease of handling and usage.

Higher Resolution

What customers consider most important for a dry laser imager is its reliability based on stable and high printing quality where minute lesions can be clearly observed. The Fujifilm Dry Laser Imager applies extremely sharp laser beams with little blur that hardly affect the surrounding pixels, achieving high CTF*1 and the output of sharp images. Merely using short interval (high dpi**2) scanning is not sufficient to obtain an absolutely clear image. With the exclusive Fujifilm Dry Imager Films, the laser beam is prevented from scattering in the film during the recording of an image, resulting in images with virtually no blur due to the unscattered beam. That is why Fujifilm Dry Laser Imagers exhibit outstanding resolution beyond the stated dpi.

*1. CTF (Contrast Transfer Function)
*2. dpi (dot per inch)

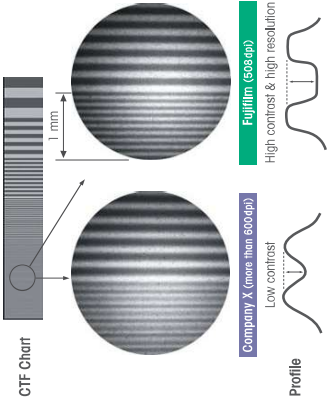

Wide-ranging Connectivity

With a built-in high-speed DICOM print server, connection is fast and error-free, allowing direct intercommunication with any modality linked to the network. An integral part of our new DRYPIX Print Networking System, networking capabilities set new standards in convenience and versatility.

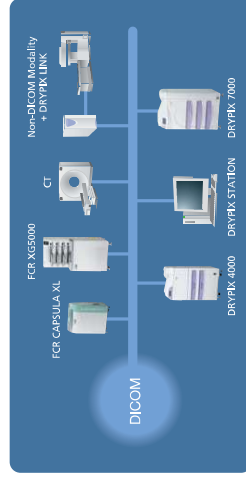

DRYPIX STATION

Optionally available DRYPIX STATION assures system reliability in multi-unit environments by automatically detecting printer failure and rerouting images to an active printer. DRYPIX STATION has two capabilities: auto-routing of images; and communicating with the workflow server to merge image information sent for DICOM storage.

DRYPIX LINK

DRYPIX LINK connects to non-DICOM modalities, sending image data to DRYPIX through the DICOM network. Connecting with optional DRYPIX STATION enhances network capability by integrating workflow information with input image data.



Dry Imaging Film

Contributing to the DRYPIX series' consistently high image quality and high throughput are Fujifilm's industry-standard dry imaging films. Their clear, high-resolution images feature low minimum density and neutral image tone, making them comparable to those of conventional wet laser imagers. The films are available in a variety of convenient sizes.

■ DI-HT for DRYPIX2000



■ DI-ML Premium Film for Mammography



■ DI-HL



* All products require regulatory approval of the importing country. For details on product availability, contact our local representative.

Consoles and Workstations

The heart of your diagnostic imaging system

CR Console/Console Advance

The CR Console and the Console Advance perform digital imaging processes – patient identification, image preview, processing, printing and storage, with DICOM interfacing. This high resolution console also uses a touch-panel screen with intuitive user guidance menus which are easy to use. And then being a PC-based image processing system, they connect with various and multiple FDRs and FCRs over the network with DICOM interface for easy connectivity with other network devices.

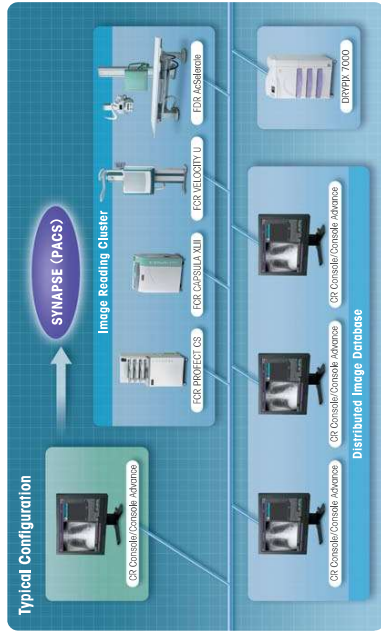

FCRView/FCR CAPSULA V VIEW FCR PRIMA Console/FCR PRIMA V Console

The FCRView and FCR PRIMA Console are multi-functional workstations for clinics that provide console, viewer, and archive functionality all combined. The FCRView can be connected to the FCR PRIMA, or the FCR CAPSULA X or XLI. The FCR PRIMA Console can only be connected to the FCR PRIMA. The FCR CAPSULA V VIEW and the FCR PRIMA V Console which are functional equivalents of the FCRView and the FCR PRIMA Console are solely for use at veterinary facilities.



SYNAPSE

PACS

The worldwide highly-evaluated PACS

Fujifilm's SYNAPSE is a web-based medical imaging and information management system that integrates image and diagnostic information within a medical institution over a specified network. Operation has been made simple so that doctors, technologists, and hospital personnel can readily obtain required information anywhere and anytime. Images and past exam data from even separate modalities can also be displayed with high image quality and high-functionality, strongly supporting patient study needs.

SYNAPSE



Austin Radiological Association



Why Fujifilm?

"With the sheer number and complexity of our facilities and subspecialties within our practice, a rules-based (auto-routing) PACS would be completely unmanageable. We wanted a system with superior flexibility to simultaneously allow for both a centralized reading model and a multi-site, distributed reading model to maximize radiologist efficiency."

Neal Rutledge, MD
Chairman of the Board
Chairman of the Practice
Austin Radiological Association

- Facility Facts**
- 1.2 Million Annual Procedures
 - 62 Radiologists
 - 2,500 Referring Physicians
 - 27 Image Acquisition Sites

- PACS Facts**
- Enterprise PACS
 - Clustered PACS Database
 - Clustered Multitouch Servers
 - EMC Symmetrix SAN
 - 40 Dual Display Workstations
 - 100s of Single Display Workstations
 - 160 Imaging Modalities
 - IDX RIS

"Our SYNAPSE PACS in combination with our high speed WAN and SAN is enabling us to further expand our practice and fuel additional growth. It will help us provide a superior service to our customers and achieve a level of efficiency not possible with other PACS approaches."

Doyle Rabe
CEO
Austin Radiological Association

Yale-New Haven Hospital



Why Fujifilm?

"CommonView™ was probably the most valuable aspect of our PACS implementation. It was the main differentiating feature among the systems we evaluated."

James Brink, MD
Chief of Diagnostic Radiology
Yale-New Haven Hospital Professor and Chairman
Dept. of Diagnostic Radiology
Yale School of Medicine
New Haven, CT

- Facility Facts**
- 300,000 Imaging exams a Year
 - 944 beds
 - 471 staff physicians
 - 45 radiologists

- PACS Facts**
- 9 acquisition sites
 - 60-70 diagnostic workstations
 - 700 general viewing workstations
 - 3,000-4,000 SYNAPSE users
 - 160 imaging modalities
 - Full CR
 - Edgewise and Teltronix HIS
 - GE RIS
 - PowerScribe and Talk Technology

"The system has allowed us to create an enterprise-wide image distribution system. A case from 7 years ago can be requested, and it will be there right away..."

Mike Matthews
Administrator
Clinical Information Systems
Yale-New Haven Hospital
New Haven, CT

SYNAPSE Cardiovascular – Fujifilm Medical Systems Cardiology

Imagine true image and information management integration specially created for cardiovascular studies: Suddenly, every department in your healthcare network, from the emergency room to non-invasive areas, is united with one database. You get a truly seamless integration of every modality. You are free to review patient studies and create comprehensive, customizable reports from a single workstation. You even have the power of advanced clinical tools right at your fingertips. And since it is completely scalable, you can be certain that you are always working with the latest technologies while still retaining all your historical data. This is the way to work efficiently and cost-effectively and the way to deliver the best possible care to your patients with SYNAPSE Cardiovascular.



SYNAPSE

cardiovascular

* All products require regulatory approval of the importing country. For details on product availability, contact our local representative.

Film/ Screen Systems

Capturing X-ray information precisely and sharply

Fujifilm's renowned high-contrast, high-resolution orthochromatic X-ray films provide optimum images for diagnosis.

General Usage Film

Super HR-T30/HR-U30

Super HR-T30 is a new high-contrast, high-resolution film for general radiography that provides consistently superb image quality. Super HR-U30 is a practical all-round film for general applications.

AD System for Chests

The Fujifilm AD System is an orthochromatic system that incorporates advanced technologies to provide high speed and sharpness with exceptionally low noise.

Mammography Film Systems

AD Mammography System

The Fujifilm AD Mammography System offers the latest film and screen technological advancements to ensure optimal image quality for mammographic applications. The system is designed to yield extremely high-contrast, D-max and sharpness with minimal noise.

UM-MA HC Film

UM-MA HC is a blue-base single-emulsion orthochromatic film for mammographic applications.



GENERAL USAGE FILM

Film	Screen				
	HR Fine	HR Medium	HR Medium Plus	HR Regular	HR Ultra Fast
Super HR-T	120	200	300	400	600
Super HR-U	Extremities Skull	Extremities, Skull, G.I. Series, Chest	G.I. Series, Abdomen, Skull	Chest, Abdomen, Pelvis, G.I. Series	Angio, Pelvis

MAMMOGRAPHY FILM RELATIVE SPEED

Film	Screen			
	AD Mammo Fine	AD Mammo Medium	UM Mammo Fine	UM Mammo Medium
AD-M	100	140	—	—
UM-MA HC	—	—	100	140

All products require regulatory approval of the importing country. For details on product availability, contact our local representative.

SPECIFICATIONS

FDR	Asiatic	FUJIFILM DR	recostr Unity	recostr Up	recostr Up	FOR Go	AMULET
Image size	17" x 17"	Exposure Unit	FPP200	HS 100	FPP200	FPP200	Approx. 15 seconds
Pixel size	150 microns	Image size	17" x 17"	4280 x 4280	—	—	50 microns
Density resolution	16 bit	Pixels	—	—	—	—	W/Mo
Preview image	2 seconds or less	Pixel size	Approx. 90 microns	—	—	—	Mg/Rh
Completion of image processing	4 seconds or less	Preview image	Approx. 90 seconds	—	—	—	XB-961E
More Details (Ref. No.)	XB-968E	X-ray Generator Power rating	50/64/80 kW	—	—	—	XB-961E
		W	2360 ^{±1}	645 ^{±2}	2350 ^{±2}	—	* 01, 03, 04, 05, 06, 07, 08, 09, 10, 11, 12, 13, 14, 15, 16, 17, 18, 19, 20, 21, 22, 23, 24, 25, 26, 27, 28, 29, 30, 31, 32, 33, 34, 35, 36, 37, 38, 39, 40, 41, 42, 43, 44, 45, 46, 47, 48, 49, 50, 51, 52, 53, 54, 55, 56, 57, 58, 59, 60, 61, 62, 63, 64, 65, 66, 67, 68, 69, 70, 71, 72, 73, 74, 75, 76, 77, 78, 79, 80, 81, 82, 83, 84, 85, 86, 87, 88, 89, 90, 91, 92, 93, 94, 95, 96, 97, 98, 99, 100, 101, 102, 103, 104, 105, 106, 107, 108, 109, 110, 111, 112, 113, 114, 115, 116, 117, 118, 119, 120, 121, 122, 123, 124, 125, 126, 127, 128, 129, 130, 131, 132, 133, 134, 135, 136, 137, 138, 139, 140, 141, 142, 143, 144, 145, 146, 147, 148, 149, 150, 151, 152, 153, 154, 155, 156, 157, 158, 159, 160, 161, 162, 163, 164, 165, 166, 167, 168, 169, 170, 171, 172, 173, 174, 175, 176, 177, 178, 179, 180, 181, 182, 183, 184, 185, 186, 187, 188, 189, 190, 191, 192, 193, 194, 195, 196, 197, 198, 199, 200, 201, 202, 203, 204, 205, 206, 207, 208, 209, 210, 211, 212, 213, 214, 215, 216, 217, 218, 219, 220, 221, 222, 223, 224, 225, 226, 227, 228, 229, 230, 231, 232, 233, 234, 235, 236, 237, 238, 239, 240, 241, 242, 243, 244, 245, 246, 247, 248, 249, 250, 251, 252, 253, 254, 255, 256, 257, 258, 259, 260, 261, 262, 263, 264, 265, 266, 267, 268, 269, 270, 271, 272, 273, 274, 275, 276, 277, 278, 279, 280, 281, 282, 283, 284, 285, 286, 287, 288, 289, 290, 291, 292, 293, 294, 295, 296, 297, 298, 299, 300, 301, 302, 303, 304, 305, 306, 307, 308, 309, 310, 311, 312, 313, 314, 315, 316, 317, 318, 319, 320, 321, 322, 323, 324, 325, 326, 327, 328, 329, 330, 331, 332, 333, 334, 335, 336, 337, 338, 339, 340, 341, 342, 343, 344, 345, 346, 347, 348, 349, 350, 351, 352, 353, 354, 355, 356, 357, 358, 359, 360, 361, 362, 363, 364, 365, 366, 367, 368, 369, 370, 371, 372, 373, 374, 375, 376, 377, 378, 379, 380, 381, 382, 383, 384, 385, 386, 387, 388, 389, 390, 391, 392, 393, 394, 395, 396, 397, 398, 399, 400, 401, 402, 403, 404, 405, 406, 407, 408, 409, 410, 411, 412, 413, 414, 415, 416, 417, 418, 419, 420, 421, 422, 423, 424, 425, 426, 427, 428, 429, 430, 431, 432, 433, 434, 435, 436, 437, 438, 439, 440, 441, 442, 443, 444, 445, 446, 447, 448, 449, 450, 451, 452, 453, 454, 455, 456, 457, 458, 459, 460, 461, 462, 463, 464, 465, 466, 467, 468, 469, 470, 471, 472, 473, 474, 475, 476, 477, 478, 479, 480, 481, 482, 483, 484, 485, 486, 487, 488, 489, 490, 491, 492, 493, 494, 495, 496, 497, 498, 499, 500, 501, 502, 503, 504, 505, 506, 507, 508, 509, 510, 511, 512, 513, 514, 515, 516, 517, 518, 519, 520, 521, 522, 523, 524, 525, 526, 527, 528, 529, 530, 531, 532, 533, 534, 535, 536, 537, 538, 539, 540, 541, 542, 543, 544, 545, 546, 547, 548, 549, 550, 551, 552, 553, 554, 555, 556, 557, 558, 559, 560, 561, 562, 563, 564, 565, 566, 567, 568, 569, 570, 571, 572, 573, 574, 575, 576, 577, 578, 579, 580, 581, 582, 583, 584, 585, 586, 587, 588, 589, 590, 591, 592, 593, 594, 595, 596, 597, 598, 599, 600, 601, 602, 603, 604, 605, 606, 607, 608, 609, 610, 611, 612, 613, 614, 615, 616, 617, 618, 619, 620, 621, 622, 623, 624, 625, 626, 627, 628, 629, 630, 631, 632, 633, 634, 635, 636, 637, 638, 639, 640, 641, 642, 643, 644, 645, 646, 647, 648, 649, 650, 651, 652, 653, 654, 655, 656, 657, 658, 659, 660, 661, 662, 663, 664, 665, 666, 667, 668, 669, 670, 671, 672, 673, 674, 675, 676, 677, 678, 679, 680, 681, 682, 683, 684, 685, 686, 687, 688, 689, 690, 691, 692, 693, 694, 695, 696, 697, 698, 699, 700, 701, 702, 703, 704, 705, 706, 707, 708, 709, 710, 711, 712, 713, 714, 715, 716, 717, 718, 719, 720, 721, 722, 723, 724, 725, 726, 727, 728, 729, 730, 731, 732, 733, 734, 735, 736, 737, 738, 739, 740, 741, 742, 743, 744, 745, 746, 747, 748, 749, 750, 751, 752, 753, 754, 755, 756, 757, 758, 759, 760, 761, 762, 763, 764, 765, 766, 767, 768, 769, 770, 771, 772, 773, 774, 775, 776, 777, 778, 779, 780, 781, 782, 783, 784, 785, 786, 787, 788, 789, 790, 791, 792, 793, 794, 795, 796, 797, 798, 799, 800, 801, 802, 803, 804, 805, 806, 807, 808, 809, 810, 811, 812, 813, 814, 815, 816, 817, 818, 819, 820, 821, 822, 823, 824, 825, 826, 827, 828, 829, 830, 831, 832, 833, 834, 835, 836, 837, 838, 839, 840, 841, 842, 843, 844, 845, 846, 847, 848, 849, 850, 851, 852, 853, 854, 855, 856, 857, 858, 859, 860, 861, 862, 863, 864, 865, 866, 867, 868, 869, 870, 871, 872, 873, 874, 875, 876, 877, 878, 879, 880, 881, 882, 883, 884, 885, 886, 887, 888, 889, 890, 891, 892, 893, 894, 895, 896, 897, 898, 899, 900, 901, 902, 903, 904, 905, 906, 907, 908, 909, 910, 911, 912, 913, 914, 915, 916, 917, 918, 919, 920, 921, 922, 923, 924, 925, 926, 927, 928, 929, 930, 931, 932, 933, 934, 935, 936, 937, 938, 939, 940, 941, 942, 943, 944, 945, 946, 947, 948, 949, 950, 951, 952, 953, 954, 955, 956, 957, 958, 959, 960, 961, 962, 963, 964, 965, 966, 967, 968, 969, 970, 971, 972, 973, 974, 975, 976, 977, 978, 979, 980, 981, 982, 983, 984, 985, 986, 987, 988, 989, 990, 991, 992, 993, 994, 995, 996, 997, 998, 999, 1000

* 1: Universal film Speed. * 2: Reader Unit.

FOR	PRIMA	CAPSULA X	CAPSULA XLI	XS-5000	PROTECT ONE	PROTECT CS	VELOCITY U	VELOCITY V	DRYPIX	PRIMA	4000	7000	2000
Processing Capacity (35 x 43 cm film)	29	43	62	103	60	103	240	140*					
18 x 24 cm (10 packs)	1464 x 2964	1464 x 2964	1464 x 2964	—	—	—	—	—					
15 x 24 cm (10 packs)	1770 x 2370	1770 x 2370	1770 x 2370	1770 x 2370	1770 x 2370	1770 x 2370	2000 x 2510	2000 x 2510					
24 x 30 cm (10 packs)	2364 x 2964	2364 x 2964	2364 x 2964	2364 x 2964	2364 x 2964	2364 x 2964	2505 x 3015	2505 x 3015					
18 x 24 cm (20 packs)	—	—	—	3540 x 4740	3540 x 4740	—	—	—					
24 x 30 cm (20 packs)	—	—	—	4728 x 5928	4728 x 5928	—	—	—					
Matrix Size	35 x 43 cm (10 packs)	35 x 43 cm (10 packs)	35 x 43 cm (10 packs)	3520 x 3520	—	—	—	—					
	35 x 43 cm (10 packs)	35 x 43 cm (10 packs)	35 x 43 cm (10 packs)	3520 x 4280	—	—	—	—					
	43 x 43 cm (10 packs)	—	—	—	—	—	4280 x 4280	4280 x 4280					
	20 x 25 cm (10 packs)	2000 x 2510	—	—	—	—	—	—					
	25 x 30 cm (10 packs)	2505 x 3015	—	—	—	—	—	—					
Applicable IP Type	ST-M	ST-VI	ST-VI	SF-VI, HR-V, SF-B0, HR-B0	SF-VI, HR-V, SF-B0, HR-B0	SF-VI, HR-V, SF-B0, HR-B0	Deviced IP	Deviced IP					
Dual Side Reading	n.a.	n.a.	n.a.	n.a.	n.a.	n.a.	n.a.	n.a.					
Dimensions (reader unit, mm)	W 600	590	590	665	665	665	645	2100					
	D 400	380	380	740	740	740	450	815					
	H 780	810	810	1480	1330	1480	1830	500 to 900					
Weight (kg)	70	99	99	270	230	270	220	411					
Power Consumption (kW)	0.17	0.2	0.29	0.7	0.7	0.7	1.0	1.0					
DICOM Compatibility	Modality Worklist, Modality Performed Procedure Step, Basic Grayscale Print, CR Image Storage, Storage Commitment												
Other Options for CR Console	Electronic Shutter, Film Annotation, Image Composition, Auto-Image Selection, LUT Adjustment, FCR CG Program, Image Enhancement, Image Annotation, Image Annotation, Patient Removal, Energy Subtraction, Pattern Enhancement Processing for Mammography												
More Details (Ref. No.)	XB-994E	XB-997E	XB-794E	XB-970E	XB-972E	XB-971E	XB-984E	XB-465E					

* Processing capacity is an assumed median of lumbar spine (40%), abdomen (20%) and extremities (40%).

* FDR Resolution - class 2 laser product (IEC60605-2).
 * FCR Resolution - class 2 laser product (IEC60605-2).
 * FCR XS-5000, FCR PROTECT ONE, FCR PROTECT CS, FCR VELOCITY U, FCR VELOCITY V, FCR PRIMA, FCR CAPSULA X, FCR CAPSULA XLI, FCR CAPSULA XLI, FCR DRYPIX 4000, DRYPIX 7000 - class 1 laser product (IEC60605-2).
 * Microsoft, Windows, and Internet Explorer are trademarks, or registered trademarks of Microsoft Corporation in the United States and/or other countries. All other trademarks are the property of their respective holders.

The logo for FUJIFILM, featuring the word "FUJIFILM" in a bold, black, sans-serif font. A small red vertical bar is positioned between the "i" and "f" in "FILM". The background is a light blue gradient with abstract circular patterns and a grid of small white dots on the right side.

FUJIFILM

FUJIFILM Corporation

<http://www.fujifilm.com/products/medical/>