



POWER SYSTEMS

AESCLAP POWER SYSTEMS

CATALOGUE – OLD SYSTEMS

Aesculap Power Systems

Aesculap – pioneer in the field of surgical power systems.

Aesculap introduced its first surgical electric motor as early as 1904. Further important milestones followed in subsequent decades with the introduction of compressed-air systems in the 1960s, the further development of flexible cable electric motors in the 1970s, the introduction of battery-driven motors in the 1980s and the development of pneumatic and electric high speed systems in the 1990s.

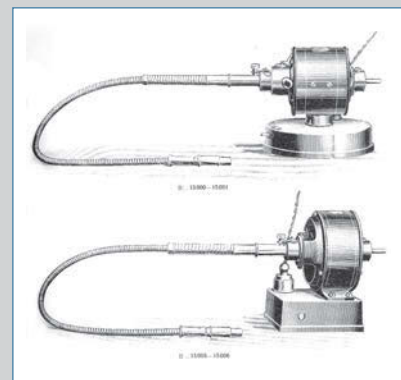

With the current systems Acculan® 3Ti, HiLAN® XS and microspeed® uni, Aesculap offers you customized solutions for virtually all fields of application. Our system range is completed by the innovative Eccos® storage system which enables timely, mechanical reprocessing of your Aesculap power systems.

Aesculap Power Systems

....get the speed you need.

How the catalogue works

1. Select motor system



GD675 **GB586R**

microspeed uni XS Hi
 High speed motor for all Hi-Line XS and Hi-Line XXS handpieces
 115 W; 10,000 – 80,000 rpm;
 ▲ ; 2.6 Ncm; 76 x 18 mm;
 80 g; Latex

● ● ● ► **Hi-Line XS, Hi-Line XXS**

consisting parts:
 GB600820 Sterilit spray adaptor Hi
 GB600870 Sterilit spray adaptor XS

indicates handpiece compatibility

Electric

2. Select handpiece & fixation



GB756R **GB614R**

Hi-Line XS handpiece
 1 ring code;
 spray nozzle GB761SU (not included)

article code fixation

Hi-Line XS

3. Select Tool

Use Burrs & Blades catalogue 017599



Aesculap® Burrs & Blades
 Catalogue 2019

017599



Chapter
 Hi-Line XS
 burrs

Hi-Line XS

Content

Power Systems

- Electric Power Systems
microspeed uni
ELAN EC
- Pneumatic Power Systems
HiLAN XS

Handpieces

- Hi Hine XS, Hi-Line XXS
- micro-Line
- mini-Line

Accessories

Processing

- Sterilit Power Systems
- Mechanical Reprocessing

Index

Electric Power Systems

microspeed uni



Electric power system for neurosurgery, neurotology and spine

- > Versatile system for small bone surgery and arthroscopy
- > Reliable and durable due to the application of top-grade material and state-of-the art technology
- > Easy operation over touch screen and function control button
- > Compatible with handpiece lines Hi-Line, Hi-Line XS, Hi-Line XXS, micro-Line and mini-Line



GD670

microspeed uni control unit
with irrigation pump; touch screen;
power cord not included;
pump flow 0 - 80 ml/min
100-240 V AC, 50/60Hz;
305 x 305 x 175 mm; 8,300 g
consisting parts:
GD412804 bottle holder



GD668

microspeed uni foot control
single pedal; protection type IPx8;
anaesthetic proof class M
5.0 m;
250 x 225 x 75 mm; 2,420 g



GD671

microspeed uni foot control
double pedal; protection type IPx8;
anaesthetic proof class M
5.0 m;
250 x 225 x 75 mm; 2,390 g



GD672

GB689R

microspeed uni motor cable
for use with motors GD674, GD676,
GD678, GD685
3.0 m; 360 g



GD673

GB689R

microspeed uni motor cable
with hand control; for use with
motors GD674, GD676, GD678,
GD685;

3.0 m; 380 g



GD676

GB578R

microspeed uni Hi 150
high speed motor for all Hi-Line
and Hi-Line XS handpieces
150 W; 10,000 - 80,000 rpm;
3.5 Ncm; 99 x 27 mm; 155 g

••► **Hi-Line, Hi-Line XS**

consisting parts:
GB600820 Sterilit spray adaptor Hi

microspeed uni



GD675

GB586R

microspeed uni XS Hi

high speed motor for all Hi-Line XS, Hi-Line XXS handpieces

115 W; 10,000 – 80,000 rpm; ↗ ↘; 2.6 Ncm; 76 x 18 mm; 80 g

••► Hi-Line XS, Hi-Line XXS

consisting parts:

GB600820 Sterilit spray adaptor Hi
GB600870 Sterilit spray adaptor XS



GD685

GB587R

microspeed uni perforator driver

to be use with cranial perforators with Hudson shank

150 W; 800 – 1,200 rpm; ↗ ↘; 2.0 Nm; 155 x 41 mm; 530 g

consisting parts:

GB600820 Sterilit spray adaptor Hi



GD678

GB578R

microspeed uni micro 150

low speed motor for all micro-Line handpieces

150 W; 1,000 – 30,000 rpm; ↗ ↘; 7.0 Ncm; 113 x 27 mm; 161 g

••► micro-Line

consisting parts:

GB600810 Sterilit spray adaptor micro-Line
GB600820 Sterilit spray adaptor Hi



GD674

GB578R

microspeed uni mini 100

low speed motor for all mini-Line handpieces except of GB398R

100 W; 1,000 – 16,000 rpm; ↗ ↘; 7.0 Ncm; 95 x 27 mm; 176 g

••► mini-Line

consisting parts:

GB600820 Sterilit spray adaptor Hi
GB600830 Sterilit spray adaptor mini-Line



GD684

GB579R

microspeed uni pistol handpiece

low speed pistol for all mini-Line handpieces except of GB373R, GB374R;

oscillation and tapping mode
100 W; 1,000 – 16,000 rpm; ↗ ↘; 7.0 Ncm; 2.5 mm; 3.0 m; 95 x 27 x 120 mm

••► mini-Line

consisting parts:

GB600830 Sterilit spray adaptor mini-Line
GD684225 K-wire guide



GD681

GB580R

microspeed uni shaver handpiece

with hand control; for Aesculap shaver tips; variable suction; automatic tip recognition; oscillation speed adjustable 0.3 – 2.0 seconds

100 W; 400 – 8,000 rpm; ↗ ↘; 3.0 m; 150 x 27 x 37 mm; 510 g

consisting parts:

GB600820 Sterilit spray adaptor Hi





GD682

GB580R

microspeed uni shaver handpiece

for Aesculap shaver tips; variable suction; automatic tip recognition; oscillation speed adjustable 0.3 - 2.0 seconds; to be used in combination with foot control GD671

100 W; 400 - 8,000 rpm;  

 3.0 m; 150 x 27 x 37 mm;

 510 g

consisting parts:

GB600820 Sterilit spray adaptor Hi

Power cords, irrigation sets and trolleys see 'Accessories'

Electric Power Systems

ELAN EC



Universal power system for all disciplines

- > Unlimited power
- > Legendary reliability and durability
- > Easy handling
- > More than 15.000 systems installed worldwide



GA835

ELAN EC control unit

with irrigation pump; power cord not included;
 pump flow 0 - 80 ml/min
 100-240 V AC, 50/60Hz;
 305 x 305 x 125 mm; 7,900 g
 consisting parts:
 GD412804 bottle holder



GA188

Foot control

waterproof (IP67) acc. to IEC601 and DIN40050; anaesthetic proof class M
 5.0 m;
 130 x 200 x 60 mm; 1,900 g



GA176

GB680R

Flexible cable micro

for all micro-Line handpieces
 0 - 20,000 rpm; 1.8 m;
 600 g

••► micro-Line

GA173

GB680R

Flexible cable micro

for all micro-Line handpieces
 0 - 20,000 rpm; 2.3 m;
 700 g

••► micro-Line

Power cords, irrigation sets and trolleys see 'Accessories'

Pneumatic Power Systems

HiLAN XS



Power, reliability and flexibility

- > HiLAN XS, HiLAN, microLAN - Integration of high and low speed
- > The pneumatic system for all applications in microsurgery

Recommended pressure for all pneumatic Aesculap Systems is 6-10 bar, 85-145 psi (technical information at 6 bar).

HiLAN XS



GA740R

GB610R

HiLAN XS

pneumatic high speed motor for all Hi-Line XS, Hi-Line XXS handpieces
50 W; 0 - 90,000 rpm; \curvearrowright ; 2.5 Ncm;
66 x 16 mm; \updownarrow 63 g

...► **Hi-Line XS, Hi-Line XXS**

consisting parts:
GB600820 Sterilit spray adaptor Hi

HiLAN



GA529

GB559R

HiLAN with hand control

pneumatic high speed motor for all Hi-Line and Hi-Line XS handpieces
50 W; 0 - 90,000 rpm; \curvearrowright ; 2.5 Ncm;
80 x 19 mm; \updownarrow 132 g

...► **Hi-Line, Hi-Line XS**

consisting parts:
GB600820 Sterilit spray adaptor Hi

GA742R

GB609R

HiLAN perforator driver

with Hudson chuck
130 W; 0 - 800 rpm; \curvearrowright ; 3.6 Nm;
130 x 37 mm; \updownarrow 495 g
consisting parts:
GB600820 Sterilit spray adaptor Hi



microLAN



GA553

GB685R

microLAN 100

pneumatic motor for all micro-Line handpieces except of GB169R, GB265R, GB268R
100 W; 0 - 20,000 rpm; \curvearrowright ; \curvearrowleft ;
8.0 Ncm; 95 x 22 mm; \updownarrow 130 g

...► **micro-Line**

consisting parts:
GB600810 Sterilit spray adaptor
micro-Line
GB600820 Sterilit spray adaptor Hi

Handpieces

Hi-Line XS, Hi-Line XXS

micro-Line

mini-Line

Hi-Line XS

Straight Hi-Line XS handpieces for the Hi-Line XS burr range



GB751R

GB611R

Hi-Line XS handpiece, straight

1 ring code;
spray nozzle GB761SU (not included)

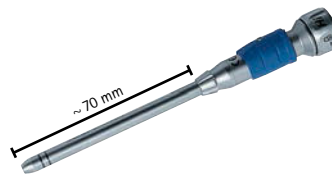

GB752R

GB611R

Hi-Line XS handpiece, straight

2 ring code;
spray nozzle GB762SU (not included)

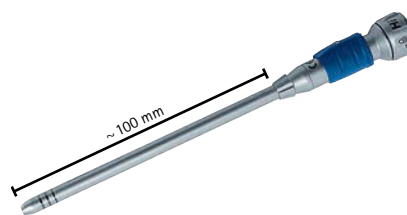

GB753R

GB611R

Hi-Line XS handpiece, straight

3 ring code;
spray nozzle GB763SU (not included)

Angled Hi-Line XS handpieces for the Hi-Line XS burr range



GB756R

GB611R

Hi-Line XS handpiece, angled

1 ring code;
spray nozzle GB761SU (not included)



GB757R

GB611R

Hi-Line XS handpiece, angled

2 ring code;
spray nozzle GB762SU (not included)

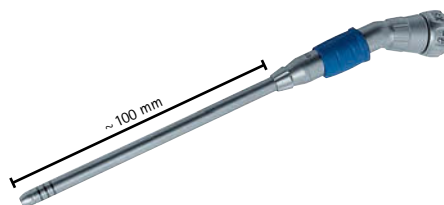

GB758R

GB611R

Hi-Line XS handpiece, angled

3 ring code;
spray nozzle GB763SU (not included)

Angled Hi-Line XS handpieces for the Hi-Line XS burr range

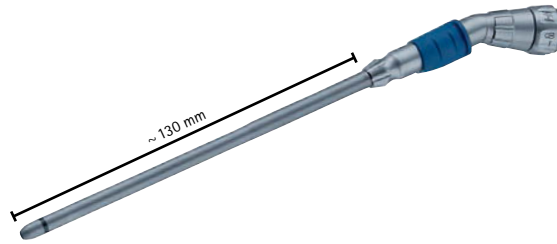

GB771R

GB611R

Hi-Line XS handpiece, angled
extra long XL1;
1 bold ring code;
spray nozzle GB764SU (not
included)

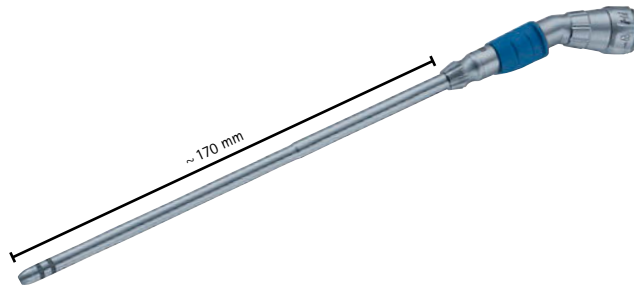

GB772R

GB611R

Hi-Line XS handpiece, angled
extra long XL2;
2 bold ring code;
spray nozzle GB765SU (not
included)

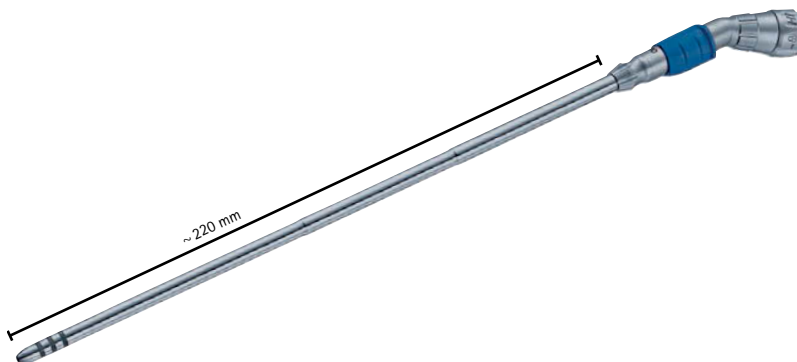

GB773R

GB611R

Hi-Line XS handpiece, angled
extra long XL3;
3 bold ring code;
spray nozzle GB766SU (not
included)

Craniotome and multipurpose handpiece



GB740R

GB611R

Hi-Line XS craniotome and multi purpose handpiece

to be used with dura guards, drill depth guard and holding sleeve GB741R - GB748R, spray nozzle GB767SU (not included)

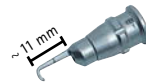

GB741R

GB615R

Hi-Line XS dura guard

fixed;
1 ring code;
to be used with craniotome burr GE420R, GE420SU, GE429SU



GB742R

GB615R

Hi-Line XS dura guard

fixed;
2 ring code;
to be used with craniotome burr GE520R, GE520SU, GE529SU



GB743R

GB615R

Hi-Line XS dura guard

fixed;
3 ring code;
to be used with craniotome burr GE620R, GE620SU, GE629SU

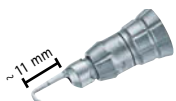

GB746R

GB615R

Hi-Line XS dura guard

steerable;
1 ring code;
to be used with craniotome burr GE420R, GE420SU, GE429SU



GB747R

GB615R

Hi-Line XS dura guard

steerable;
2 ring code;
to be used with craniotome burr GE520R, GE520SU, GE529SU

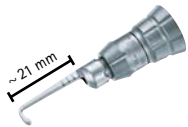

GB748R

GB615R

Hi-Line XS dura guard

steerable;
3 ring code;
to be used with craniotome burr
GE620R, GE620SU, GE629SU



GB744R

GB615R

Hi-Line XS drill depth guard

for craniotome handpiece and
multipurpose handpiece GB740R
2 - 8 mm



GB745R

GB615R

Hi-Line XS holding sleeve

for craniotome handpiece and
multipurpose handpiece GB740R

Hi-Line XXS

Handpiece for minimal-invasive approaches for the Hi-Line XXS burr range



GB790R GB605R

Hi-Line XXS handpiece
to be used with the handpiece shafts GB791R - GB794R



GB791R GB606R

Hi-Line XXS handpiece shaft, straight
2 ring code
spray nozzle GB796SU (not included)

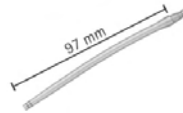

GB792R GB606R

Hi-Line XXS handpiece shaft, curved
2 ring code
spray nozzle GB796SU (not included)



GB793R GB606R

Hi-Line XXS handpiece shaft, straight
3 ring code
spray nozzle GB797SU (not included)



GB794R GB606R

Hi-LineXXS handpiece shaft, curved
3 ring code
spray nozzle GB797SU (not included)

Hi-Line XS
Hi-Line XXS

micro-Line

For burrs with shank diameter of 2.35 mm



GD450M

GB681R

micro-Line handpiece

coding: 1 blue ring;
for 70 mm burrs;
suitable spray nozzle GD460R (not
included)
1:1; 97 mm



GD451M

GB681R

micro-Line handpiece

coding: 1 blue ring;
for 95 mm burrs;
1:1; 127 mm

For burrs with shank diameter of 2.35 mm; angulation 21°



GD455M

GB681R

micro-Line handpiece, angled

coding: 1 red ring;
for 70 mm burrs;
suitable spray nozzle GD460R (not
included)
1:2; 120 mm



GD456M

GB681R

micro-Line handpiece, angled

coding: 1 red ring;
for 95 mm burrs;
1:2; 150 mm



GD457M

GB681R

micro-Line handpiece, angled

coding: 1 red ring;
for 125 mm burrs;
1:2; 180 mm

For use with micro-inserts with imperator gearing, angulation 21°



GB111

GB681R

micro-Line handpiece

coding: 1 green ring;
suitable spray nozzle GA227R (not
included)
4:1; 74 mm



GB173

GB690R

Imperator attachment

for burrs with 2.35 mm diameter;
up to 70 mm length; minimal shaft
length 30 mm; spray nozzle
GA227R (not included)
1:1; 43 mm

micro-Line



GB164

Mounting tool
for imperator attachment GB173



GB119

GB690R

Contra angle head
coding: 1 green dot;
for tools with Dental shank
2:1; 43 mm



GD305

GB681R

micro-Line reciprocating saw
keyless; suitable spray nozzle
GD306R (not included)
2,5:1; \downarrow 1.3 mm; \uparrow 48 g
consisting parts:
GD320R saw blade



GD307

GB681R

micro-Line sagittal saw
with captive nut; suitable spray
nozzle GD308R (not included)
2,5:1; \angle 7°; \uparrow 50 g
consisting parts:
GD372206 key



GB129

GB682R

micro-Line sagittal saw
spray nozzle GA222R (not included)
1:1; \angle 4°46'; \uparrow 345 g
consisting parts:
GB125804 nut
TE472 ring spanner



GB128R

GB682R

micro-Line transversal saw
suitable spray nozzle GA221R (not
included)
1:1; \angle 10°24'; \uparrow 385 g
consisting parts:
GB020R allen key



GB130R

GB682R

micro-Line reciprocating saw
suitable spray nozzle GA223R (not included)
1:1; † 3.0 mm; † 310 g
consisting parts:
TA004634 key



GB200

GB682R

micro-Line drill pistol
spray nozzle GA221R (not included)
↖ ↗; 20:1; † 2.7 mm; † 700 g



GB222

Jacobs chuck
Ø 0 - 4 mm
consisting parts:
GA062R key



GB223

Jacobs chuck
Ø 0.6 - 7.4 mm
consisting parts:
GA031R key



GB224

Small AO chuck



GB227R

K-wire driver
for K-wires from 0.6 to 2.5 mm



GB231R

GB682R

micro-Line Dermatome acc. to Wagner

cutting width keyless adjustable;
thickness adjustable (1/10 mm steps);
cutting thickness: 0.2 - 1.2 mm;
cutting width: max. 78 mm
6:1; † 3.0 mm; † 770 g
consisting parts:
GB228R blades



GB169R

GB682R

micro-Line drill

for exchangeable chucks
20:1; † 280 g
consisting parts:
GC523200 ring spanner



GB106R

Hudson chuck
for GB169R



GB265R

GB682R

micro-Line craniotome

with turnable duraguard
1:1; † 200 g
consisting parts:
GB266M turnable dura-guard
GB267R handpiece
GC303R burr



GB268R

GB682R

micro-Line craniotome

with fixed duraguard
1:1; † 200 g
consisting parts:
GB267R handpiece
GB298R fixed dura-guard
GC303R burr



GB292

GB681R

**micro-Line pediatric craniotome,
Freiburg pattern**

with fixed duraguard
1:1; † 100 g
consisting parts:
GB109 handpiece
GB291R dura-guard
GC304R burr

mini-Line



GB376R

GB673R

mini-Line burr attachment

straight; for 2,35 mm shank; for burrs up to 70 mm length; suitable spray nozzle GB378 (not included)
32,000 rpm; 1:2; 108 g



GB382R

GB673R

mini-Line drill attachment

for tools with AO shank; suitable spray nozzle GB378 (not included)
1,000 rpm; 16:1; 98 g



GB383R

GB673R

mini-Line drill attachment

Jacobs chuck; suitable spray nozzle GB378 (not included)
Ø 0 - 4 mm
1,000 rpm; 16:1; 2.5 mm;
160 g
consisting parts:
GA062R key



GB377R

GB673R

mini-Line heavy duty drill attachment

Jacobs chuck; suitable spray nozzle GB378 (not included)
Ø 0.6 - 7.4 mm
800 rpm; 36:1; 2.5 mm;
220 g
consisting parts:
GA031R key



GB373R

GB673R

mini-Line angled drill attachment

for tools with dental shank
2,000 rpm; 8:1; 91 g



GB398R

GB674R

mini-Line K-wire attachment

for use with GD684;
for K-wires from 0.6 to 2.5 mm
1,000 rpm; 16:1; 190 g



GB374R

GB673R

mini-Line angled K-wire attachment

for use with straight mini motors;
for K-wires from 0.6 to 1.6 mm
900 rpm; 17:1; 120 g



GB390R

GB673R

mini-Line sagittal saw attachment

16,000 rpm; 1:1; \angle 5°; 100 g



GB391R

GB673R

mini-Line reciprocating saw attachment

16,000 rpm; 1:1; \downarrow 2.1 mm; 100 g



GB392R

GB674R

mini-Line transversal saw attachment

16,000 rpm; 1:1; \angle 10°; 140 g



GA187R

GB673R

micro-Line adaptor

handpiece: micro;
motor: mini

Accessories



GA411

microspeed uni mobile stand
adjustable height
I1200 - 1500 mm



GA415

Mobile stand
for ELAN, microspeed EC and
Microtron devices; adjustable
height
I1200 - 1500 mm



GD416M

Mobile stand
for AESCULAP control units
I1320 mm
consisting parts:
GD414R



GD412804

Bottle holder

Accessories



TE780

Power cord Europe; black

 1.5 m

TE730

Power cord Europe; black

 5.0 m

TE734

Power cord UK; black

 5.0 m

TE735

**Power cord USA, Canada, Japan;
black**

 3.5 m

Wall outlet

Motor inlet

Air hoses



AESCULAP Dräger



AESCULAP small

GA505R

GB564R

GA513R

GB564R

Air hose

5.0 m

Air hose

3.0 m

Wall outlet

Motor inlet



AESCULAP Dräger



AESCULAP small

GA523R

GB564R

Air hose

(for irrigation pump GA530)

2.3 m

Wall outlet

Motor inlet



DIN

Schrader with diffusor



AESCULAP small

AESCULAP small

GA507R

GB576R

Air hose

5.0 m

Recommended pressure for all pneumatic AESCULAP Systems is 6 - 10 bar, 85 - 145 psi
 Motor connection small fits: GA502, GA508R, GA519, GA520R, GA529, GA551, GA552, GA553, GA554, GA740R, GA741R, GA742R
 Motor connection large fits: GA200, GA430, GA437, GA440, GA521, GA530

Wall outlet

Motor inlet



Schrader with diffusor



AESCULAP small

GA506R

GB575R

Air hose

5.0 m

Wall outlet

Motor inlet



AESCULAP Dräger



AESCULAP large

GA464R

GB463R

Air hose

3.0 m

GA466R

Air hose

5.0 m

GA460R

GB463R

Air hose, spiral type

3.0 m

Wall outlet

Motor inlet



DIN



AESCULAP large

GA463R

Air hose

3.0 m

GA465R

Air hose

5.0 m

Wall outlet

Motor inlet



DIN with diffuser



AESCULAP large

GA461R

Air hose

3.0 m

Wall outlet

Motor inlet



Aesculap-Dräger
Schrader with diffuser



AESCULAP Dräger
AESCULAP large

GA468R

Air hose

5.0 m

GB480R

Recommended pressure for all pneumatic AESCULAP Systems is 6 - 10 bar, 85 - 145 psi
Motor connection small fits: GA502, GA508R, GA519, GA520R, GA529, GA551, GA552, GA553, GA554, GA740R,
GA741R, GA742R
Motor connection large fits: GA200, GA430, GA437, GA440, GA521, GA530

Wall outlet



AESCULAP Dräger

Motor inlet



AESCULAP Dräger

Extension hoses

GA194R

Extension hose

3.0 m

GA195R

Extension hose

5.0 m

Wall outlet



DIN

Motor inlet



DIN

GA087

Extension hose

5.0 m

Pneumatic accessories



GA521

Foot control

for pneumatic systems
air inlet: large
air outlet: AESCULAP Dräger



GA099

Air pressure reducer

air pressure reducer with DIN quick lock coupling; for compressed air cylinders acc. to DIN477 G5/8" AG; air inlet 100 - 200 bar / 2130-2840 psi
consisting parts:
GA088C DIN quick lock coupler



GA088C

Quick lock coupler
for air pressure reducer GA099; for
DIN system



GA091C

Quick lock coupler
for french system



GA508R

Angled hose adaptor
for all small Aesculap motors



GA206R

Adaptor for pneumatic systems
AESCULAP motor large - Synthes air
hoses

GB474R

Irrigation



GA530

Irrigation pump

for pneumatic systems; to be used with tubing set GA391SU and GA526P (not included)
 pump flow 0- 80 ml/min
 100-240 V AC, 50/60Hz;
 305 x 305 x 135 mm; 15,500 g
 consisting parts:
 GD412804 bottle holder



GA391SU

Tubing Set

complete;
 including adaptor for spray nozzles, fixation clips and punch for irrigation bottle;
 for microspeed uni, Microspeed EC, Microtron EC, HiLAN (in connection with GA526P)
 ☒ package of 10 pieces



GA392SU

Tubing set with Y-Adaptor

complete;
 including adaptor for spray nozzles, fixations clips and punch for irrigation bottle;
 for microspeed uni
 ☒ package of 10 pieces



GA391

Tubing set

complete; including adaptor for spray nozzles, fixation clips and punch for irrigation bottle; for ELAN (micro and mini cable only); HiLAN in connection with GA526P
 ☒ package of 10 pieces



GA526P

Fixation clips

for combining tubing set GA391 or GA391SU with pneumatic motors
 ☒ package of 8 pieces

Adaptor



GB421R



Hudson adaptor

tool: Hudson;
motor: Harris
⌀ 3.8 mm



GB422R



AO large adaptor

tool: AO large;
motor: Harris
⌀ 3.8 mm



GB423R



DIN adaptor

tool: DIN;
motor: Harris
⌀ 3.8 mm



GB425R



Hudson/Zimmer adaptor

tool: Zimmer/Hudson;
motor: Harris
⌀ 3.8 mm



GB426R



Jacobs chuck

tool: Jacobs;
motor: Harris
Ø 0,6 - 7,4 mm
⌀ 3.8 mm



GB628R



Synthes DHS/DCS adaptor

tool: Synthes DHS/DCS;
motor: AO large
⌀ 4.2 mm



GB182R

GB690R

Harris adaptor
tool: Harris;
motor: Hudson
not canulated



GB184R

GB690R

Harris adaptor
tool: Harris;
motor: AO large
⌀ 3.5 mm



XF457R

GB690R

DIN adaptor
tool: DIN;
motor: AO large
⌀ 3.8 mm



GB007R

GB690R

AO large adaptor
tool: AO large;
motor: DIN
⌀ 4.0 mm



GB187R

GB690R

Harris adaptor
tool: Harris;
motor: triangle
⌀ 3.5 mm



GB176R

GB467R

Zimmer Adapter
tool: Zimmer
motor: Hudson/Zimmer
only in combination with GB630R or
GB656R
⌀ 3.8 mm



GA187R

GB673R

micro-Line adaptor

handpiece: micro;
motor: mini

Keys



GA031R

GB690R

Key

for big Jacobs chuck
suitable for GB223R, GB386R,
GB416R, GB426R, GB424R,
GB177R, GB638R, GB658R



GA186209

GB690R

Key

for mini-coupling
suitable for GA186, GA551, GA552,
GA647, GD674, GD684



TE472

GB690R

Ring spanner

for Aesculap star coupling



GB020R

GB690R

Allen Key

suitable for GB101, GB102R,
GB115R, GB121R, GB125R, GB210R,
GB230R, GB377R



GA062R

GB690R

Key

for small 4mm Jacobs chuck
suitable for GB108R, GB166R,
GB181R, GB222R, GB383R, GB415R



GD372206

Key

width across flats 6,0 mm
suitable for GD307



GC523R

Ringspanner

suitable for GA522R, GB106R,
GB108R, GB169R

Skin graft mesher



BA720R

GB688R

Skin graft mesher

for use in combination with skin
carriers BA721 (1:1,5) /
BA722 (1:3) / BA723 (1:6)
150 x 195 x 105 mm; 4,600 g
consisting parts:
BA725R cutting roller
BA726R ratchet wrench



BA725R

Cutting roller



GB141

Cement syringe
for cement injector GB171N; with
special injection tubing
50 ml



GB171N

Cement injector w. Harris shank
for disposable syringe GB141

Bone mill



GB040

Bone mill
for use with motor or crank handle
consisting parts:
GB042R crushing drum



GB042R

Crushing drum
standard; Harris shaft; section of
the produced bone chip
0.7 x 3 mm



GB043R

Crushing drum
fine; Harris shaft; section of the
produced bone chip 0.7 x 2 mm



GB044R

Crushing drum
coars; Harris shaft; section of the
produced bone chip 0.7 x 4 mm

Accessories



GB041R

Crank handle for GB040



GB046

**Insert for GB040
for small bone grafts**

Processing

Sterilit Power Systems

Mechanical Reprocessing

Sterilit Powersystems

Sterilit Power Systems



GB600

Sterilit Power Systems

300 ml

📦 package of 6 pieces



GB600810

Sterilit Power Systems spray adaptor

for micro-Line



GB600820

Sterilit Power Systems spray adaptor

for HiLAN, HiLAN XS, Hi-Line (XS, XXS), Microspeed EC, microspeed uni, microLAN, miniLAN



GB600830

Sterilit Power Systems spray adaptor

for mini-Line



GB600870

Sterilit Power Systems spray adaptor

for microspeed uni XS



GA059

Sterilit drip lubricator

50 ml

Mechanical Reprocessing

Mechanical Reprocessing

The solution for storage and mechanical reprocessing of your Aesculap Power Systems

Basic requirements for mechanical reprocessing in combination with our storage system:

- > A suitable cleaner must be used (pH < 11 for aluminum components)
- > The temperature in the cleaning cycle must not exceed 60°C
- > Clean for at least 3 minutes
- > Apply intermediate rinse for at least 1 minute
- > Carry out intensive final rinse with distilled, demineralised or fully desalinated water
- > Only thermal disinfection: 5 minutes rinse at max. 96°C with distilled, demineralised or fully desalinated water
- > Complete the programme with a drying phase of at least 10 minutes at a temperature of not more than 120°C

microspeed uni



GB579R
ECCOS Fixation
for GD684
56 mm



GB578R
ECCOS Fixation
for GD674, GD676, GD678
56 mm

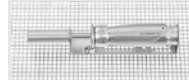

GB689R
ECCOS Fixation
for GD672, GD673
56 mm

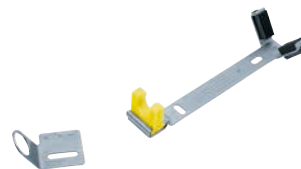

GB580R
ECCOS Fixation
for GD682, GD681
56 mm



GB587R
ECCOS Fixation
for GD685
56 mm



GB586R
ECCOS Fixation
for GD675
56 mm



ELAN EC



GB680R

ECCOS Fixation
for GA173, GA176
56 mm



microLAN

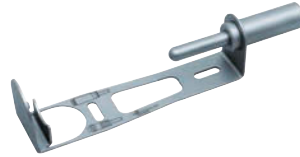

GB685R

ECCOS Fixation
for GA502, GA553, GA554, GD657,
GD658
56 mm



HiLAN XS/HiLAN



GB577R

ECCOS Fixation
for pneumatic Aesculap motors
with mounted angled hose adaptor
GA508R
56 mm

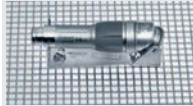

GB610R

ECCOS Fixation
for GA740R, GA741R
56 mm

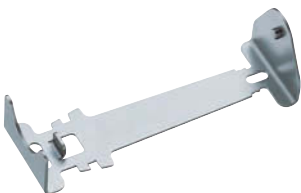

GB609R

ECCOS Fixation
for GA742R, GA522R
56 mm



Hi-Line XS



GB611R

ECCOS Fixation for 1 Hi-Line XS handpiece

for GB740R, GB751R, GB752R, GB753R, GB756R, GB757R, GB758R, GB771R, GB772R, GB773R

56 mm



GB613R

ECCOS Fixation

for 13 burs of the Hi-Line XS, Hi-Line or 2,35 mm shaft range

36 mm

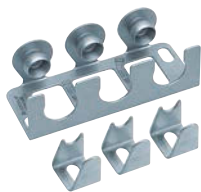

GB614R

ECCOS Fixation for 3 Hi-Line XS handpieces

for GB740R, GB751R, GB752R, GB753R, GB756R, GB757R, GB758R, GB771R, GB772R, GB773R

56 mm



GB615R

ECCOS Fixation

for GB741R - GB748R

56 mm

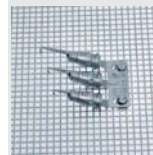

Hi-Line XXS



GB605R

ECCOS Fixation for 1 Hi-Line XXS handpiece

for GB790R

56 mm



GB606R

ECCOS Fixation for 2 Hi-Line XXS shafts

for GB791R, GB792R, GB793R, GB794R

56 mm

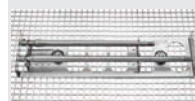



GB693

Ceramic filter for cleaning devices GB694R-GB696R



GB694R

Cleaning devices for 3 Hi-Line XS handpieces

not suitable for autoclaving
consisting parts:
GB693



GB695R

Cleaning devices for 3 micro-Line handpieces

not suitable for autoclaving
consisting parts:
GB693



GB696R

Cleaning devices for 4 Hi-Line XXS shafts

not suitable for autoclaving
consisting parts:
GB693

micro-Line



GB681R

ECCOS Fixation

for GB109, GB110, GB111, GB112, GB113, GB114R, GB291R, GB292R, GD305, GD307, GB310, GD450M, GD451M, GD452M, GD455M, GD456M, GD457M, GD465M, GD466M, GD467M

 56 mm



GB682R

ECCOS Fixation

for GB128R, GB129, GB130R, GB166R, GB169R, GB200, GB231R, GB265R, GB267R, GB268R, GB280, GB801R

 76 mm



GB686R

ECCOS Fixation

for GB266, GB298, GB436R

 56 mm



mini-Line

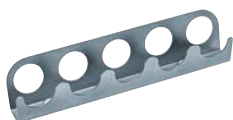

GB673R

ECCOS Fixation

for GB373R, GB374R, GB376R, GB377R, GB379R, GB380R, GB381R, GB382R, GB383R, GB386R, GB390R, GB391R

 56 mm



GB674R

ECCOS Fixation

for GB385R, GB388R, GB389R, GB392R, GB397R, GB398R

 56 mm



Mechanical Reprocessing

Accessories



GB564R

ECCOS Fixation
for GA505R, GA513R, GA523R
76 mm



GB463R

ECCOS Fixation
for GA460R, GA464R, GA466R
76 mm



GB575R

ECCOS Fixation
for GA506R
76 mm



GB576R

ECCOS Fixation
for GA507R
56 mm



GB480R

ECCOS Fixation
for GA468R
76 mm

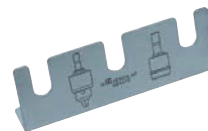

GB467R

ECCOS Fixation
for GB421R, GB422R, GB423R,
GB424R, GB425R
56 mm





GB481R

ECCOS Fixation
for saw blades and other
accessories
56 mm



GB572R

ECCOS Fixation
for GB300R - GB308R
56 mm



GB690R

ECCOS Fixation
for GB173R, GB119, GB154, GB194,
GB628R, GA031201, GB424201,
GA437224, GB009C
36 mm



GB459R

Mounting kit

Mechanical Reprocessing

microspeed uni



GB255R

ECCOS Set microspeed uni

Neurosurgery

56 mm

consisting parts:

GB586R

GB587R

GB614R

GB615R

GB689R

JF212R

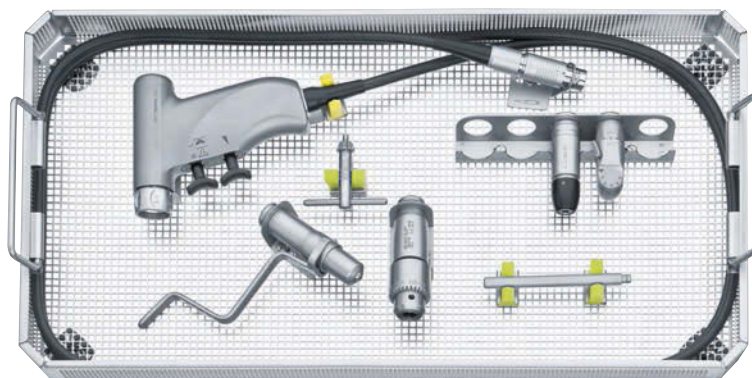

GB254R

ECCOS Set microspeed uni

small bone surgery

56 mm

consisting parts:

GB579R

GB673R

GB674R

GB690R

JF212R

HiLAN XS

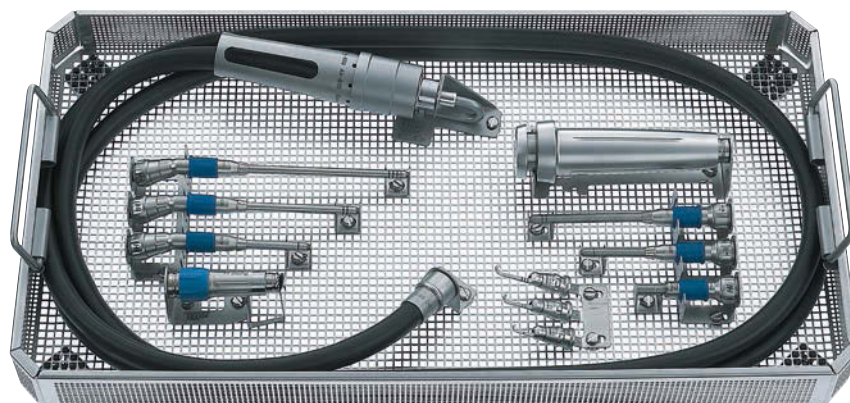

GB252R

ECCOS Set HiLAN XS

56 mm

consisting parts:

GB564R

GB609R

GB610R

GB614R

GB615R

JF212R

Index

Index by reference numbers

BA720R	40	GB043R	41	GB564R	51	GB757R	17
BA725R	40	GB044R	41	GB572R	52	GB758R	17
		GB046	42	GB575R	51	GB771R	18
GA031R	39	GB106R	26	GB576R	51	GB772R	18
GA059	44	GB111	23	GB577R	47	GB773R	18
GA062R	40	GB119	24	GB578R	46	GB790R	21
GA087	34	GB128R	24	GB579R	46	GB791R	21
GA088C	35	GB129	24	GB580R	46	GB792R	21
GA091C	35	GB130R	25	GB586R	46	GB793R	21
GA099	34	GB141	41	GB587R	46	GB794R	21
GA173	11	GB164	24	GB600	44		
GA176	11	GB169R	26	GB600810	44	GC523R	40
GA186209	39	GB171N	41	GB600820	44		
GA187R	28, 39	GB173	23	GB600830	44	GD305	24
GA188	11	GB176R	38	GB600870	44	GD307	24
GA194R	34	GB182R	38	GB605R	48	GD372206	40
GA195R	34	GB184R	38	GB606R	48	GD412804	29
GA206R	35	GB187R	38	GB609R	47	GD416M	29
GA391	36	GB200	25	GB610R	47	GD450M	22
GA391SU	36	GB222	25	GB611R	48	GD451M	22
GA392SU	36	GB223	25	GB613R	48	GD455M	22
GA411	29	GB224	25	GB614R	48	GD456M	23
GA415	29	GB227R	25	GB615R	48	GD457M	23
GA460R	32	GB231R	26	GB628R	37	GD668	7
GA461R	33	GB252R	53	GB673R	50	GD670	7
GA463R	33	GB254R	53	GB674R	50	GD671	7
GA464R	32	GB255R	53	GB680R	47	GD672	7
GA465R	33	GB265R	26	GB681R	50	GD673	7
GA466R	32	GB268R	26	GB682R	50	GD674	8
GA468R	33	GB292	26	GB685R	47	GD675	8
GA505R	31	GB373R	27	GB686R	50	GD676	7
GA506R	32	GB374R	28	GB689R	46	GD678	8
GA507R	31	GB376R	27	GB690R	52	GD681	8
GA508R	35	GB377R	27	GB693	49	GD682	9
GA513R	31	GB382R	27	GB694R	49	GD684	8
GA521	34	GB383R	27	GB695R	49	GD685	8
GA523R	31	GB390R	28	GB696R	49		
GA526P	36	GB391R	28	GB740R	19	TE472	39
GA529	13	GB392R	28	GB741R	19	TE730	30
GA530	36	GB398R	27	GB742R	19	TE734	30
GA553	13	GB421R	37	GB743R	19	TE735	30
GA740R	13	GB422R	37	GB744R	20	TE780	30
GA742R	13	GB423R	37	GB745R	20		
GA835	11	GB425R	37	GB746R	19	XF457R	38
		GB426R	37	GB747R	19		
GB007R	38	GB459R	52	GB748R	20		
GB020R	39	GB463R	51	GB751R	16		
GB040	41	GB467R	51	GB752R	16		
GB041R	42	GB480R	51	GB753R	16		
GB042R	41	GB481R	52	GB756R	17		

Overview tool attachments

AO big

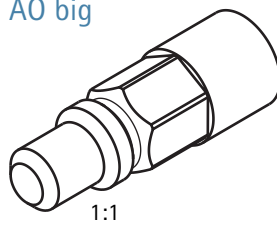

AO small

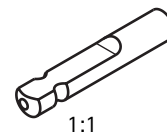

Dental

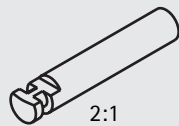

DIN

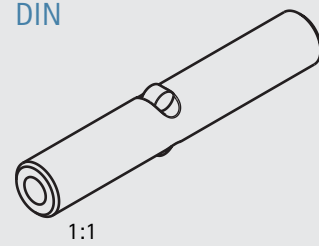

Harris

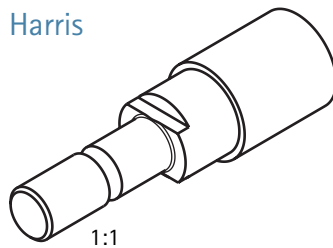

Hudson

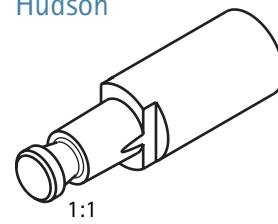

Hexagon

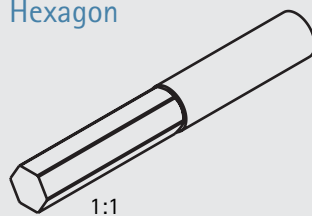

Synthes DHS/DCS

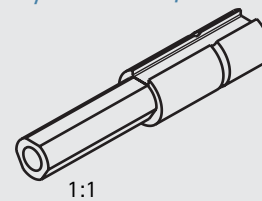



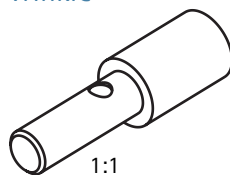



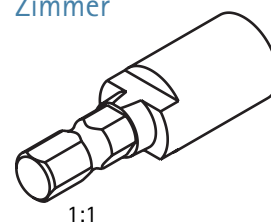







Trinkle



Zimmer



Signs and symbols

	Article code Eccos® fixation
	Forward / reverse drive
	Forward drive
	Oscillation frequency
	Oscillation angle
	Stroke
	Cannulation
	Cable length
	Weight
	Sterile
	Single use
	Latex free
	Packaging Unit
	Required height of tray
	Suitable handpiece-line

AESFULAP[®] – a B. Braun brand

Aesculap AG | Am Aesculap-Platz | 78532 Tuttlingen | Germany
Phone +49 7461 95-0 | Fax +49 7461 95-2600 | www.aesculap.com