



Service Manual

Sartorius Competence | Sartorius Gem^{plus}

CPA-, CP-, GC- und GP-Models

Electronic Semimicro- and Analytical Precision Balances and Precious Metal Scales

Including Service Specifications Sheets

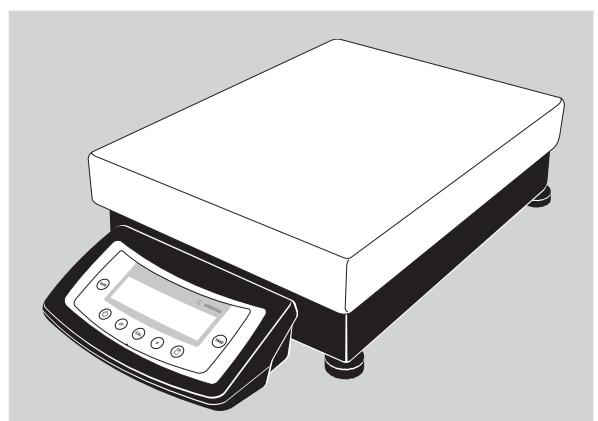
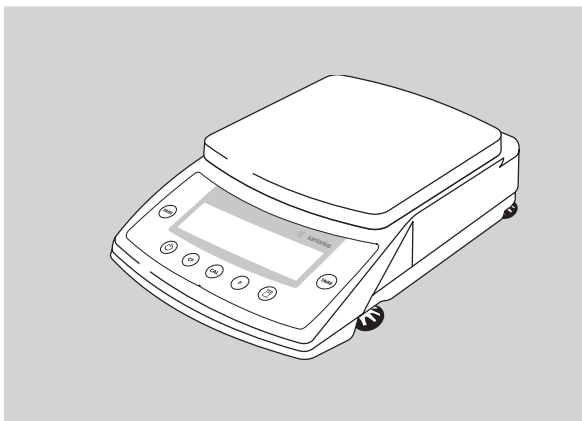
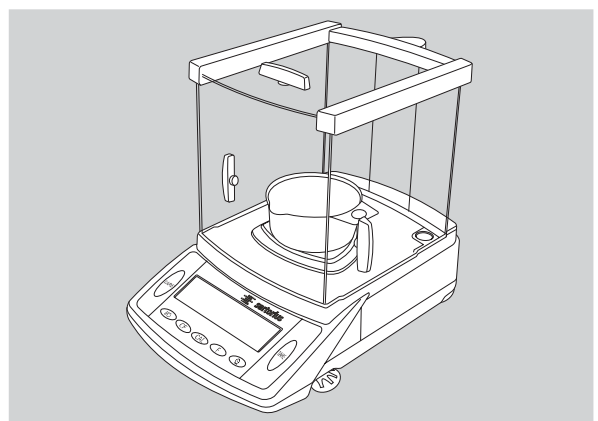
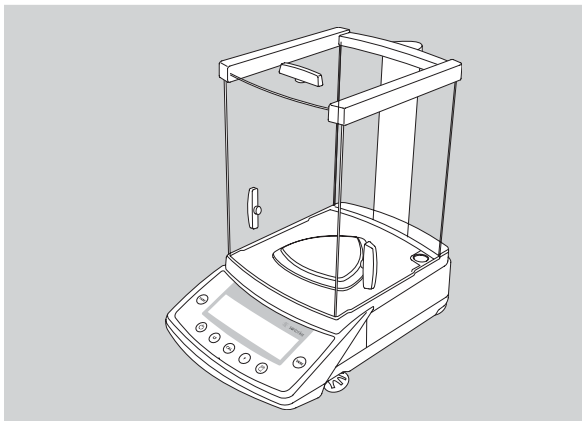
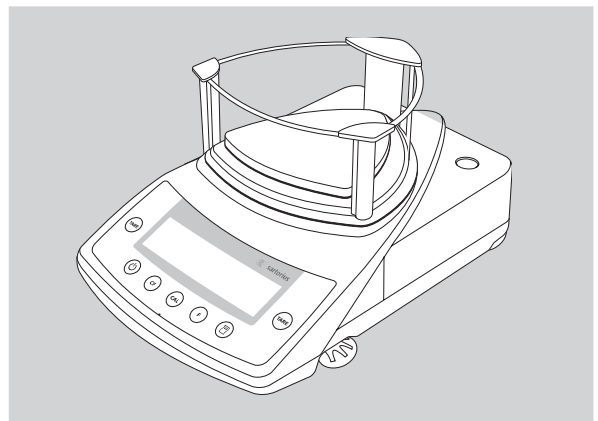
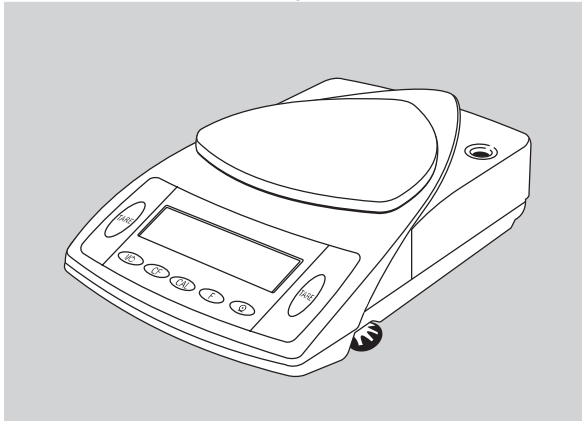

Page		
03	General Information	
03	Fundamentals at a Glance	
04	The Most Important Information at a Glance	26
04	Service Concept for the CP/GC/GP Scale/ Balances	26 27
04	General Notes	27
05-06	New Features Compared to the BP	
06-07	Models with Special Weighing Systems	28
08	Auxiliary Service Tools, Equipment and Weights	28
08	Accompanying Literature	
09	Handling and Operation	28
09	Function of the Keys	28
09	Displaying the Hardware and Software Versions	29
10	Function of the Service Switch and Access Lock Switch	29 29
10	Access Lock Switch	29
11	Brief Instructions Balance/Scale Operating Menu	
11-12	Accessing and Setting the Balance/Scale Oper- ating Menu	30 31
13-14	Menu Code Settings(Rel BAC 13.44 Version)	31
15	Function of the BPI Switch	31
15	Activating the BPI Mode	32
16	Testing and Adjusting Balances/Scales with Strain Gauge Systems	33
16	Testing and Adjustment Sequence on Balances/ Scales with Strain Gauge Systems	33
16	Checking the Overload Stop	35
16	Setting the Overload Stop	35
17	Zero-Point Offset Adjustment	
17	1. Adjustment with a Digital Voltmeter	35
17	2. Adjustment using the Service Software (Sartocas / Psion)	35 36
18	Checking the Repeatability (standard deviation)	36
18	Checking and Adjusting the Off-Center Loading Error	36
18	Checking the Off-Center Loading Tolerances	
19-20	Procedure for Adjusting the Off-Center Loading Error (Strain Gauge)	37
21	Span Adjustment	38
21	External Adjustment	39
22	Adjusting Linearity	39
22	Adjusting External Linearity	39
23	Testing and Adjusting Balances/Scales with Double- Lever Systems	40-41 Error Codes
23	Testing and Adjustment Sequence on Balances/ Scales with Double Lever Systems	42-44 Calibration/Adjustment Data
23	Checking the Overload Stop	
23	Checking the Repeatability (standard deviation)	
24	Checking and Adjusting the Off-Center Loading Error	
24	Checking the Off-Center Loading Tolerances	
25	Procedure for Adjusting the Off-Center Loading Error (Double Lever Systems)	
	Span Adjustment	
	External Adjustment	
	Adjusting Linearity	
	Adjusting External Linearity	
	Balance/Scale with Monolithic Weigh Cells	
	Testing and Adjustment Sequence on Balances/Scales with Monolithic Weigh Cells	
	Checking the Overload Stop	
	Checking the Repeatability (standard deviation)	
	Off-Center Loading Error	
	Checking and Adjusting the Off-Center Loading Error	
	Checking the Off-Center Loading Tolerances	
	Procedure for Adjusting the Off-Center Loading Error (Monolithic Weigh Cells)	
	3-Point Adjustment	
	Span Adjustment	
	External Adjustment	
	Overwriting the Internal Calibration Weight	
	Internal Span Adjustment	
	Linearity	
	Checking the Linearity	
	Adjusting the Linearity	
	Overwriting the Internal Linearization Weight	
	Balances/Scales with Forked Lever Systems	
	Testing and Adjustment Sequence on Balances/Scales with Forked Lever Systems	
	Checking the Overload Stop	
	Checking the Repeatability (standard deviation)	
	Off-Center Loading Error	
	Checking and Adjusting the Off-Center Loading Tolerances	
	Procedure for Checking the Off-Center Loading Tolerances	
	Procedure for Adjusting the Off-Center Loading Error (Forked Lever Systems)	
	External Adjustment	
	Linearity	
	Checking the Linearity	
	Adjusting the Linearity	

Generals Information

Fundamentals at a Glance

We strongly recommend completing a service training course at Sartorius before performing work on Sartorius weighing instruments. Please do not attempt or permit any unauthorized repair work.

The following CP models will be/have been replaced by CPA models:

Standard models:	<u>CP - Models</u>	=	<u>Nachfolger CPA</u>		<u>CP - Models</u>	=	<u>Nachfolger CPA</u>
	CP64	=	CPA64		CP124S	=	CPA124S
	CP224S	=	CPA224S		CP324S	=	CPA324S
	CP225D	=	CPA225D		CP34000	=	CPA34000
	CP4201	=	CPA4201		CP6201	=	CPA6201
	CP8201	=	CPA8201		CP12001S	=	CPA12001S
	CP16001S	=	CPA16001S		CP34001S	=	CPA34001S
	CP34001S	=	CPA34001S		CP622	=	CPA622
	CP2202S	=	CPA2202S		CP3202S	=	CPA3202S
	CP4202S	=	CPA4202S		CP153	=	CPA153
	CP323S	=	CPA323S		CP423S	=	CPA423S

Important Note:

All CPA models have an overlay that is different from the one on CP models (see page 9).

The analytical balances with model names CPA324S and CPA224S and higher have a monolithic weigh cell.

stamp approved models:	<u>CP - Models</u>	=	<u>Nachfolger CPA</u>		<u>CP - Models</u>	=	<u>Nachfolger CPA</u>
	CP124S-ACE	=	CPA124S-PCE		CP12001S-OCE	=	CPA12001S-OCE
	CP224S-PCE	=	CPA224S-PCE		CP16001S-OCE	=	CPA16001S-OCE
	CP64-OCE	=	CPA64-OCE		CP34001S-OCE	=	CPA34001S-OCE
	CP124S-OCE	=	CPA124S-OCE		CP622-OCE	=	CPA2202S-OCE
	CP224S-OCE	=	CPA224S-OCE		CP2202S-OCE	=	CPA2202S-OCE
	CP324S-OCE	=	CPA324S-OCE		CP3202S-OCE	=	CPA3202S-OCE
	CP225D-OCE	=	CPA225D-OCE		CP4202S-OCE	=	CPA4202S-OCE
	CP523S-PCE	=	CPA523S-PCE		CP153-OCE	=	CPA223S
	CP3202S-ACE						
	CP4202S-PCE						
	CP4202S-ACE	=	CPA4202S-PCE				
	CP34000-OCE	=	CPA34000-OCE				
	CP34001P-OCE	=	CPA34001P-OCE				
	CP2201-OCE	=	CPA2201-OCE				
	CP6201-OCE	=	CPA5201-OCE				
	CP8201-OCE	=	CPA8201-OCE				

Service Concept for CPA/CP/GC/GP Balances/Scales

Valid until further notice

- All calibration/adjustment work required for starting up operations and testing must be carried out in accordance with the operation instructions.
- Quality defects.
 - o Immediately report all quality defects that may occur to the Quality Assurance Department (WQM).
- Defective balances/scales
 - o Warranty.
 - Within the first 6 months of installation, any defective balance/scale covered by the warranty should be exchanged.
 - o Seal of warranty.
 - If you have to remove the Seal of Warranty, please affix your control seal with the Sartorius logo to the unit!
 - o In other cases, proceed according to the OAW135 (standard operating procedure for returns for repairs).
 - Defective weighing cells. Proceed as described in the Service Concept for Weighing Cells, refer to (Service Information Document 6.2001 / OAW135-2/3).
 - Defective electronics. These balances/scales along with an error record should be sent back to the Central Mechanics Workshop (ZW) in Goettingen (OAW135-2).
 - Other service situations can be dealt with on site, for example: Broken draft shields; weighing pan can no longer be used; replacing small parts, ... etc.

General Notes

Transport:

- Always turn off the CP/GC balance/scale first by pressing the  button and then wait about 10 seconds before you pull the mains plug. If the balance/scale with an internal calibration weight is currently running in the calibration mode, the internal calibration weights are exposed. This can cause the weighing system to be damaged during transport. By switching off the balance/scale properly, they will be locked.
- Before you plug in or remove any connecting cables, always separate the balance/scale from the power supply, as otherwise components can become destroyed.

How to change the battery:

Important Note!

When exchanging the battery (if available), be sure that

- you use a new battery that is identical to the old one or equivalent to the battery recommended by the manufacturer.
- the poles are correctly positioned when soldering in the battery.

Warning: If you use the wrong battery, this may result in an explosion.

Be sure to dispose of the defective battery properly according to your country's environmental protection laws!

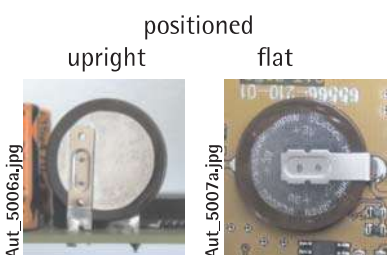

New Features Compared to the BP:	New, different housings (see Overview, Page 6)
Procedure: Checking the balance/scale	<ol style="list-style-type: none"> 1. Check the repeatability <ul style="list-style-type: none"> Balance/Scale with strain gauge system (standard deviation, see page 18) Balance/Scale with double lever system (standard deviation, see page 23) Balance/Scale with monolithic weigh cell (standard deviation, see page 28) Balance/Scale with forked lever system (standard deviation, see page 35) 2. Checking the off-center loading error and adjust as required <ul style="list-style-type: none"> Balance/Scale with strain gauge system (see page 18) Balance/Scale with double lever system (see page 24) Balance/Scale with monolithic weigh cell (see page 29) Balance/Scale with forked lever system (see page 36-37) 3. Adjusting the sensitivity with internal calibration weight <ul style="list-style-type: none"> Balance/Scale with monolithic weigh cell (see page 32) 4. Adjusting the sensitivity with external calibration weight <ul style="list-style-type: none"> Balance/Scale with strain gauge system (see page 21) Balance/Scale with double lever system (see page 26) Balance/Scale with monolithic weigh cell (see page 31) Determine the internal calibration weight as required (see page 31) balance/scale with forked lever system (see page 38) 5. Adjusting the linearity is preferably performed using the sequential method, or with calibrated weights, <ul style="list-style-type: none"> Balance/Scale with strain gauge system (see page 22) Balance/Scale with double lever system (see page 27) Balance/Scale with monolithic weigh cell (see page 33) Check the internal linearization weights as required (see page 34) Balance/Scale with forked lever system (see page 39)
Activating the BPI Mode/ Deactivating write-protect	Perform only before working with the SARTOCAS Program or PSION; for calibration/adjustment. Linearization and programming a data record when exchanging the main PCB.
Reset write-protect	After working with the SARTOCAS program or PSION, always make sure to conclude with the „Close“ function (returning the balance from BPI back to SBI mode), otherwise write-protect is not set, and the balance/scale remains in the BPI mode (see Page 11). If all else fails, reset the SBI mode by pressing menu reset (9-1°).
Exchanging the Main PCB	When ordering replacement PCBs, always state the model and the serial number, that is the only way that a new preprogrammed PCB set can be delivered.
Opening the housing	<ul style="list-style-type: none"> - Unscrew the 1 (sealed) screw on the reverse side and slide the upper half of the housing back. - After reclosing the balance/scale, the service technician or service organization must reattach another control seal!
Triangular weighing pan	<ul style="list-style-type: none"> - Check the off-center loading error according to the OIML Recommendation R76, see 4-point test (Pages 18; 24; 29) - when carrying out adjustment/calibration work using the 3-point test (page 30)
Blue backlighting	<ul style="list-style-type: none"> - Is adjustable and can be switched off
Service software	<ul style="list-style-type: none"> - TradeCAS or SartoCAS starting with Version 1.44 Psion CAS Version 4.9 and later. Do not use older software versions!
Adjusting the off-center load	<ul style="list-style-type: none"> - On strain gauge, Angled lever and double lever systems perform by filing on monolithic weigh cell with adjustment screws

Weighing systems

- Strain gauge on low-resolution balances/scales,
Double lever system and forked lever system on high resolution precision balances
Monolithic weigh cells on analytical balances

Span adjustment

- With external weights on precision balances not verified for legal metrology
- With built-in weights on analytical balances and precision balances verified for legal metrology

Linearity

- Is internally possible using (2 built-in weights) on analytical balances,
- On other models with external service software (CAS, PC/ PSION)

Menu locking

- Menu access can be blocked by entering code (8-1-2) of the balance/scale operating program
- The access lock switch is only functional on calibration models (calibration/ adjustment externally blocked)

BPI switch

- (BPI = Binary Processor Interface) to prepare for working with CAS service software, log out with „CLOSE“ function
- Or if all else fails by resetting the operating menu (9-1°)
Be careful, the factory settings are activated.
ERR 30 is also shown after pressing the  key, if the wrong interface cable is used!

Models with Special Weighing Systems

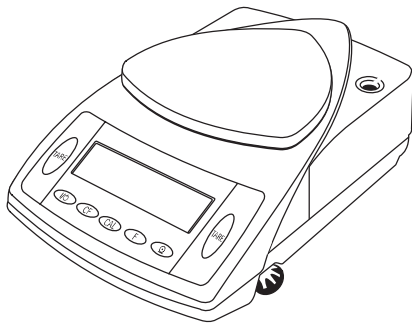

CP_01b.eps

Model 1

Weighing system: Strain gauge
(Strain gauge) (see right)
CP622



Aut_4906.jpg

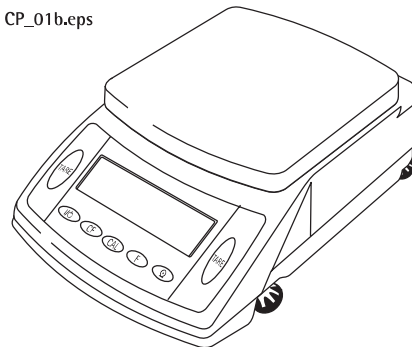

CP_01b.eps

Model 2

Weighing system:
Strain gauge (see right)
CP8201, CP6201, CP4201, CP2201,
GP8201



Aut_4910.jpg

CP_01.eps

Weighing system:
Angled lever (see below, right)
CP4202S, CP3202S, CP3202P,
CP2202S, GP5202, GP3202

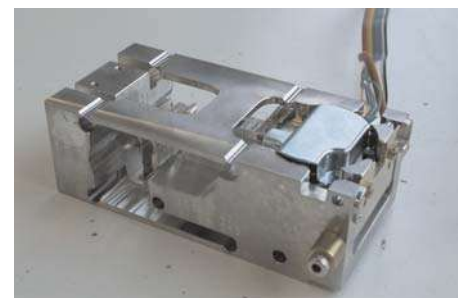

Aut_4915.jpg

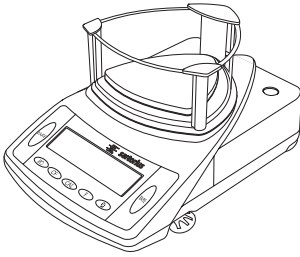

CP_06.eps

Model 3

Weighing system:
Angled lever (see right)
CP423S, CP323S, CP323P, CP153



Aut_5259.jpg

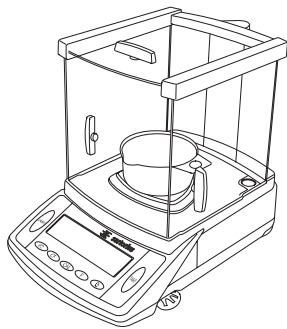

CP2_02.eps

Model 3

Weighing system:
Angled lever (see right)
GC2502



Aut_5259.jpg

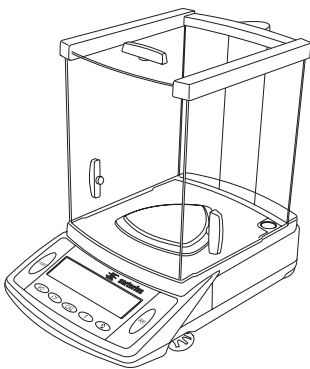

CP2_01.eps

Model 4

Weighing system:
Monolithic (see right)
CP225D, CP324S, CP224S, CP124S,
CP64, GC1603, GC803S, GC803P

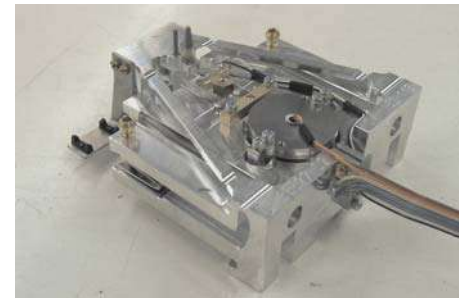

Aut_4920.jpg

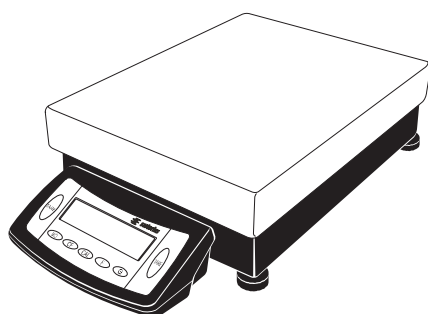

CP2_11.eps

Model 5

Weighing system:
Fork lever (see right)
CP34001S, CP34001P, CP34000,
CP16001S, CP12001S



Aut_5254.jpg

Auxiliary Service Tools, Equipment and Weights

Caution:

After removing the seal (warranty label) and finishing service work, reattach your control seal with the Sartorius logo!

Please make sure that you use the proper tools and equipment and that the balance/scale is set up on a solid, level surface and in a clean work area that is free of vibrations and drafts.

PSION CAS Version 4.9 and later
Service software CAS for PC Version 1.44 or later 6740-33

and

RS232 connecting cable (25-Pin) 7357312

or

RS232 connecting cable (9-Pin) 7357314

Tool Kit Angled file 6740-80

In addition to your standard tools and equipment, you will need the following sets of weights when working on Sartorius Competence balances/scales:

For Model	Accuracy class (OIML)	Weight in grams	Catalog No.:
CP CPA			
CP64	E2	1x50	YCW4528
CP124S, GC803 S/P	E2	1x100	YCW5128
CP323P, CP153	F1	1x100	YCW5138
CP225D, CP224S	E2	1x200	YCW5228
CP324S, GC1603P	E2	1x200+ 1x100	YCW5228 + YCW5128
CP423S, CP323S, GC 2502	F1	1x200	YCW5238
CP622	F2	1x500	YCW5548
CP3202P, CP2202S	F1	1x1000	YCW6138
CP4202S, CP3202S, CP4201, CP2201, GP3202	F1	1x2000	YCW6238
CP8201, GP8201, CP6201	F1	1x5000	YCW6538
CP34001S, CP34001P, CP16001S, CP12001S, CP34000	F1	1x10000	YCW7138

Accompanying Literature

Operating Instructions Sartorius Competence/CP/CPA Series/Sartorius Gemplus Publication No: WCP6006-e05073

Function of the Keys

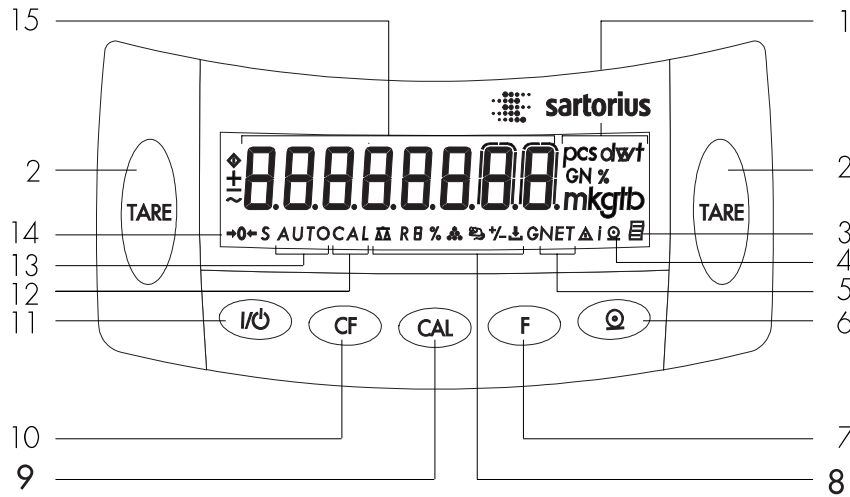

Position Description

- 1 Weighing unit
- 2 Taring
- 3 Pictograph for „GLP-compliant print-out active“
- 4 Pictograph for „Printing active“
- 5 Display: occupied memory in the net total applications program
- 6 Data output (Print)
- 7 Function key: activates selected applications program
- 8 Pictograms for the selected application
- 9 Activate calibration/adjustment mode

Position Description

- 10 Clear Function
This key is used as an abort key:
- Deactivate applications program
- Interrupt calibration/adjustment mode
- 11 ON/OFF key:
Shuts the display on and off.
(The balance/scale may remain on - depending on the factory setting.)
- 12 Display: Calibration/adjustment mode
- 13 Display: animal weighing with automatic start
- 14 Pictograph for stand-by operations or zero range
- 15 Weight display depending on the selected basic unit

Displaying the Hardware and Software Versions

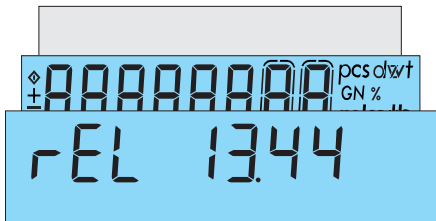

Anz_07-F.eps

- Turn the balance/scale on and back off again with the button.
- While all display segments are lit („Segment Test“), briefly press the key, the pattern shown to the left appears in the display.
- This remains displayed for around 3 sec.
- The first number shows the hardware generation; the last two numbers the software version.

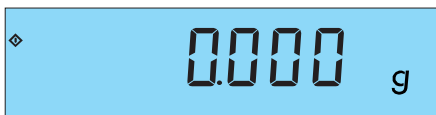

Anz_00-F.eps

- The display then returns to the normal weight readout mode.

Access Lock Switch

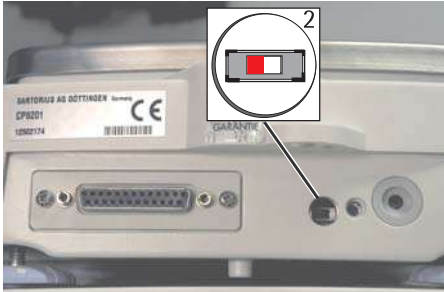

Aut_4106.jpg / CP_bpi_sch.eps

The access lock switch (2) is located on the rear panel of the balance/scale. On models CP622, CP4202S, CP3202S, CP3202P, CP2202S, GP5202, GP3202, CP8201, CP6201, CP4201, CP2201, GP8201, CP423S, CP323S, CP323P, CP153, GC2502, CP225D, CP324S, CP224S, CP124S, CP64, GC1603, GC803S, GC803P, the opening on the left is intended for the access lock switch (2) (see figure on the left).

With the CP225D it's in an external electronics box

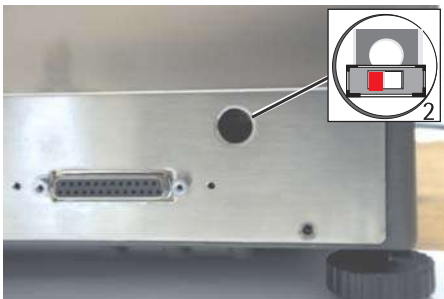

Aut_4106.jpg / CP_bpi_t_sch.eps

On models CP34001S, CP34001P, CP34000, CP16001S, CP12001S, the opening on the left is intended for the access lock switch (2) (see figure on the left).

C

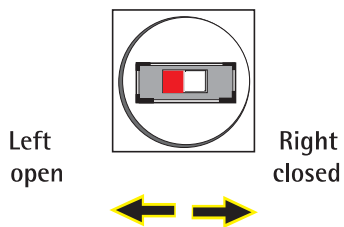

A

should only be operated on models verified for use in legal metrology!

Depending on the model (verifiable or standard), the switch has two functions.

1. To unlock the menu to change the menu code settings „ 1 9 2 „ the external span adjustment on verifiable balances/scales. External adjustments are generally possible on standard models. It is not necessary to open or close the switch.
2. After the menu is activated „ 8 1 2 „ (read only parameter), it can be released by moving the switch (2) read only (right position) or for changing the settings (left position).



Note:



On verified models, span adjustment can be carried out with external weights without the service software.

Procedure:

1. Open access lock switch
2. Activate menu „ 1 9 7 „
3. Press the **CAL** key
4. Adjust the balance/scale
5. Close access lock switch!!

Accessing and Setting the Balance Operating Menu

Accessing the Menu Using the „“ „“ keys:

- Turn the balance/scale off and back on by pressing the  button.
- While all segments are displayed (Segment Test), briefly press .
- „1“ is displayed.

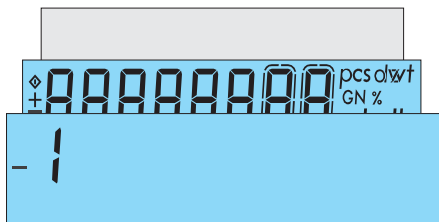

Anz_01-F.eps

Note:

If „-1“ is displayed, this indicates that the operating menu is blocked by the menu access switch (see figure on the left). Menu code setting „8 1 2“ (read only parameters) is activated.

To unlock the menu to change the menu code settings, move the menu access switch to the left. Move the switch back to the right after you have made your changes!

Selecting a Menu Code Setting Using the „“ and „“ Keys:

- Press  to select the desired number. Numbers increase by one each time they are pressed and go from 9 back to 1 again (1, 2, 3 ... 8, 9, 1 ...).

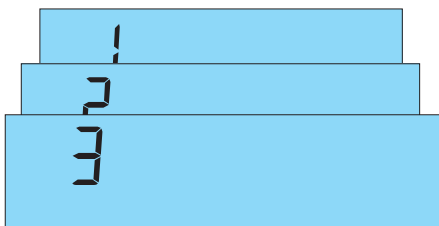

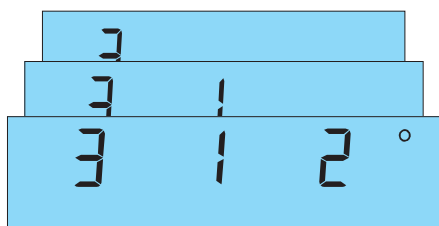

Anz_02-F.eps

- Press  to move from the first code number to the second and third numbers (1st - 2nd - 3rd etc.). Numbers increase by one each time they are pressed and go from 3 back to 1 again (1st - 2nd - 3rd - 1st etc.).



Anz_03-F.eps

Changing and Storing a Setting with the „“ Key:

- Briefly press one of the  keys to confirm desired setting. A „°“ appears after the new setting, e.g. „3-1-3 °.“
- To store the setting, press one of the  keys for more than two seconds.

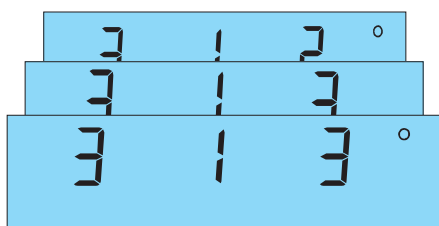

Anz_04-F.eps

Exiting the Menu Without Storing:

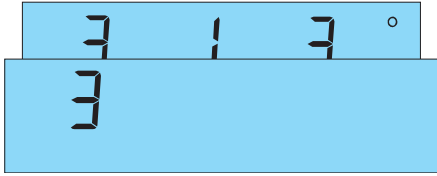

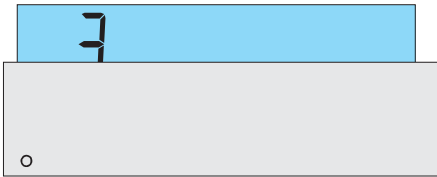

Anz_05-F.eps

- To exit the menu, press . This returns you to the first position in the balance/scale operating menu.







Anz_06-F.eps





- If you do not wish to store the changes, press the  key to deactivate this menu item during the selection procedure or before storing by pressing  (balance/scale is switched off).

Menu	1 Weighing		1 11	Weight Unit	for Calibration Weight *
	1 1	Filter Selection			
	1 1 1	Very stable conditions	1 11 1	o	Grams
	1 1 2	o Stable conditions	1 11 2		Kilograms
	1 1 3	Unstable conditions	1 11 3		Pounds
	1 1 4	Very unstable conditions			
	1 2	Applications Filter	Menu	2 Application Programs	
	1 2 1	o Standard weighing mode	2 1	Program selection	
	1 2 2	Manual filling mode	2 1 1	o	Weighing as the basic function
	1 3	Stability Range	2 1 2		Toggle weight units (mass unit conversion)
	1 3 1	1/4 digit	2 1 4		Counting
	1 3 2	1/2 digit	2 1 5		Weighing in percent
	1 3 3	1 digit	2 1 6		Net total formulation
	1 3 4	o 2 digits	2 1 7		Animal weighing / Averaging
	1 3 5	4 digits			
	1 3 6	8 digits*	Menu	3	Application Parameters
	1 5	Tare Parameter*	3 1	2nd Weight Unit	
	1 5 1	At any time	3 1 1		Grams (Display: o)*
	1 5 2	o Not until readout is stable	3 1 2	o	Grams (Display: g)
	1 6	Auto Zero Function	3 1 3		Kilograms
	1 6 1	o Auto Zero on	3 1 4		Carats
	1 6 2	Auto Zero off	3 1 5		Pounds*
	1 7	1st Weight Unit	3 1 6		Ounces*
	1 7 1	Grams (Display: o)*	3 1 7		Troy ounces*
	1 7 2	o Grams (Display: g)	3 1 8		Hong Kong tael*
	1 7 3	Kilograms	3 1 9		Singapore tael*
	1 7 4	Carats	3 1 10		Taiwanese tael*
	1 7 5	Pounds*	3 1 11		Grains*
	1 7 6	Ounces*	3 1 12		Pennyweights*
	1 7 7	Troy ounces*	3 1 13		Milligrams
	1 7 8	Hong Kong tael*	3 1 14		Parts per pound*
	1 7 9	Singapore tael*	3 1 15		Chinese tael*
	1 7 10	Taiwanese tael*	3 1 16		Mommes*
	1 7 11	Grains*	3 1 17		Austrian carats*
	1 7 12	Pennyweights*	3 1 18		Tola*
	1 7 13	Milligrams	3 1 19		Baht*
	1 7 14	Parts per pound*	3 1 20		Mesghal*
	1 7 15	Chinese tael*	3 2	Range 2 Display Mode *	
	1 7 16	Momme*	3 2 1	o	All digits
	1 7 17	Austrian carats*	3 2 5		Reduced by 1 digit
	1 7 18	Tola*	3 5	Resolution for Counting and Weighing in Percent	
	1 7 19	Baht*	3 5 1		Display accuracy (internal resolution)
	1 7 20	Mesghal*	3 5 2	o	Full accuracy
	1 8	Range 1 Display Mode*	3 6	Decimal Places for Calculations	
	1 8 1	o All digits	3 6 1		None
	1 8 5	Reduced by 1 digit*	3 6 2	o	Without one decimal place
	1 9	(CAL) Calibration /Adjustment Function	3 6 3		Without two decimal places
	1 9 1	o External calibration/adjustment ¹⁾	3 6 4		Without three decimal places
	1 9 3	Internal calibration/adjustment ³⁾	3 7	Animal Activity for Delaying Start until:	
	1 9 5	External linearization ³⁾	3 7 1		Stable conditions (calm)
	1 9 6	Internal linearization/calibration ³⁾	3 7 2	o	Normal
	1 9 7	(CAL) key blocked ⁴⁾	3 7 3		Unstable conditions (active)
	1 10	Calibration /Adjustment Sequence	3 8	Animal Weighing Will Start by	
	1 10 1	o Calibrate, then auto adjust	3 8 1		Manual mode
	1 10 2	Calibrate, then manual adjust	3 8 2	o	Automatic mode

⁴⁾ If Access Switch is locked (otherwise extern Cal./adjustment)

Menu 4	Application Parameters – Counting
4 1	Auto reference sample updating function
4 1 1	o Off
4 1 2	o On
Menu 5	Data Interface
5 1	Baud rate
5 1 1	150 baud
5 1 2	300 baud
5 1 3	600 baud
5 1 4	o 1200 baud
5 1 5	2400 baud
5 1 6	4800 baud
5 1 7	9600 baud
5 1 8	19200 baud
5 2	Parity
5 2 1	Mark
5 2 2	Space
5 2 3	o Odd
5 2 4	Even
5 3	Number of Stop Bits
5 3 1	o 1 stop bit
5 3 2	2 stop bits
5 4	Handshake Mode
5 4 1	Software handshake
5 4 2	o Hardware handshake, 2 char. after CTS
5 4 3	Hardware handshake, 1 char. after CTS
Menu 6	Utilities for Printouts/ Basic Function Weighing
6 1	Manual/Auto print
6 1 1	Manual with  key without stability
6 1 2	o Manual with  key after stability
6 1 3	Manual with  key at stability
6 1 4	Auto print without stability
6 1 5	Auto print at stability
6 1 6	Auto print when load changes 2)
6 2	Automatic Printing
6 2 1	Start/stop auto print using the  key
6 2 2	o Auto print not stoppable
6 3	Time-Dependent Printouts at Defined Intervals
6 3 1	o 1 display update
6 3 2	2 display update
6 4	Automatic Taring after Each Printout
6 4 1	o Off
6 4 2	On
Menu 7	Print Application Programs
7 1	Print Application Parameter
7 1 1	Off
7 1 2	o On; all param.
7 1 3	On; only main parameters

7 2	Print Format
7 2 1	Raw data (16 char.)
7 2 2	o For other apps (22 char.)
7 3	Auto Print Net Total Formulation / 2nd Tare Memory
7 3 1	o Auto print last value N1
7 3 2	Auto print total T1

Menu 8	Extra Functions
8 1	Menu Access Function *
8 1 1	o Parameter settings alterable
8 1 2	Read only
8 2	Acoustic signal
8 2 1	o On
8 2 2	Off
8 3	Key Functions
8 3 1	o Accessible
8 3 2	Blocked
8 4	Universal Switch for Remote Control
8 4 1	o 
8 4 2	
8 4 3	
8 4 4	
8 4 5	
8 5	Power-On Mode
8 5 1	o Off/on/Stand-by
8 5 3	Stand-by/on
8 5 4	Auto on
8 8	Reference Weighing for Counting Small Parts
8 8 1	o Off
8 8 2	On for QC scale
8 8 3	On for FB/FC/LA/LP scales
8 8 4	On for isi terminal
8 10	ISO/GLP-compliant Printout
8 10 1	o No ISO/GLP-compliant printout
8 10 2	Only for calibration/adjustment
8 10 3	Always on – all printouts ISO/GLP-compliant
Menu 9	Reset Menu to Factory Settings
9 – 1	Restore
9 – 2	o Do not restore Also resets SBI mode

Caution: Before resetting the menu, note down the menu settings

* = Not used for on balances/scales verified for legal metrology.

1) = Not possible on balances/scales of accuracy class  verified for legal metrology

2) = Auto print, when weight changes > 10 d and
Stability: menu access switch < 5 d

3) = Only on models with internal r weight switch

o) = Model-dependent factory setting

Activating the BPI Mode

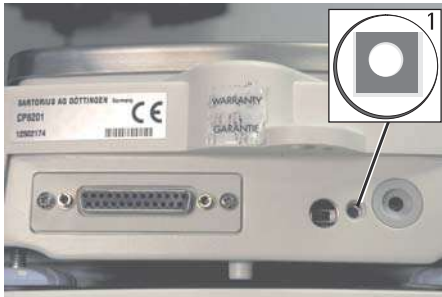

Aut_4106.jpg / CP_bpi_t.eps

The BPI switch (1) is used to prepare for working the service software and is located on the rear panel.

On models CP622, CP4202S, CP3202S, CP3202P, CP2202S, GP5202, GP3202, CP8201, CP6201, CP4201, CP2201, GP8201, CP423S, CP323S, CP323P, CP153, GC2502, CP225D, CP324S, CP224S, CP124S, CP64, GC1603, GC803S, GC803P, the middle opening is intended for the BPI switch (1) (see figure left).

With the CP225D it's in an external electronics box

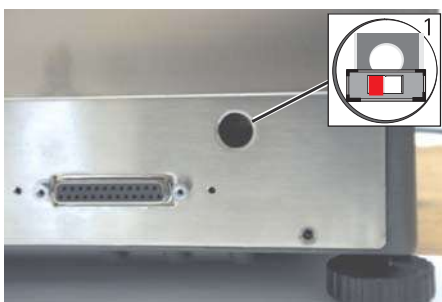

Aut_4106.jpg / CP_bpi_t_sch.eps

On models CP34001S, CP34001P, CP34000, CP16001S, CP12001S, on opening is intended for the BPI switch (1) (see figure left).

Note:

To use the CAS programs (Version 1.44 and later) or the SARTORIUS MC1 Server (version 4.9 and later and later), the balance/scale must be set to the BPI mode (= Binary Processor Interface Mode) (e.g. for linearization /span adjustment or when replacing the PCB).

- Turn on the balance/scale using the e key and wait for the segment test on the balance/scale to run, i.e. until (e.g. CP423S) „ 0.000 g „ is displayed.
- Remove the capped plug from the rear panel of the balance, located to the left of the DC jack (screw).
- The BPI switch is now accessible through the opening. Press the BPI switch once, e.g. with a ball-point pen and hold it in:

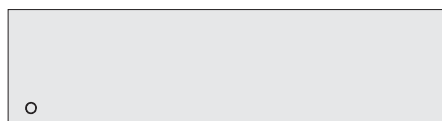

Anz_OFF.eps

- The weight readout in the display disappears (8-er-check it is executed).
- After about 3 seconds, the interface will be in the BPI mode.

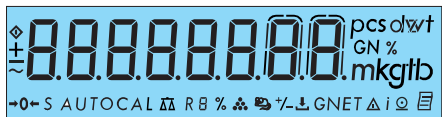

Anz_88-F.eps

- Release the BPI switch, the balance/scale now returns automatically to the normal weight readout mode, but is still in the BPI Mode. (Only SARTOCAS is functional).



Anz_00-F.eps

- Insert the plug to close the opening on the back panel of the balance/scale.
- You can now use the balance/scale together with the SARTOCAS program (version 1.44 and later) for PCs or the Psion server (version 4.9 and later) in the BPI Mode.

Caution!

After working in the BPI Mode, make sure to set the write-protect (with the SARTOCAS program for SARTORIUS MC1 Server (Version 4.9 and later)), so that the balance/scale returns to the standard data record output mode (SBI mode = Sartorius Balance Interface).

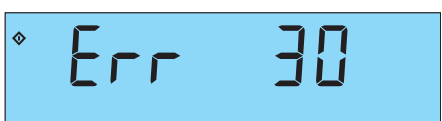

Anz_err30-F.eps

If the balance/scale is in the BPI Mode (= Binary Processor Interface Mode) when you press  key, the error code ERR 30 will be displayed!

You cannot run the standard peripheral devices until you set the balance/scale back to the SBI mode!

Note:

If necessary, it is possible to switch from SBI to BPI by activating the menu setting »9 - 1« (menu reset).

Testing and Adjustment Sequence on Balances/Scales with Strain Gauge Systems

Preparations:

Place the balance/scale on a solid, level surface that is free of vibration, e.g. a stone table. Level the balance/scale using the level indicator. Turn the balance/scale and allow it to warm up for about 30–60 minutes, depending on the model. Calibrate/adjust the balance/scale on this place.

Note:

Testing must be carried out according to the following Sartorius Standard Operating Procedure for Testing WKD-037-02 and WKD-038-02. They are also equivalent to the given adjustment data as described in this service manual.

You will need to check and, if necessary, adjust the following:

1. Overload stop
2. Zero point offset adjustment
3. Repeatability
4. Off-center loading error
5. Span adjustment
6. External linearity

Checking the Overload Stop

Note:

Overload stops only need to be checked after replacing a strain gauge system.

Setting the Overload Stop

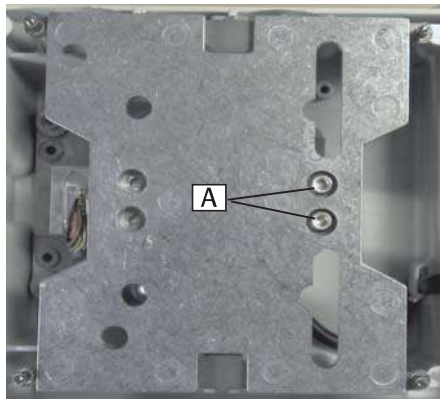

Waagenplatte.tif

Setting the overload stops is only necessary in the case of mechanical damage or after replacing the load cell!

After opening the balance/scale, screw off the load plate and remove it from the weighing system.

If there is only one load plate, the two screws (A) have to be removed to obtain access to the strain gauge.

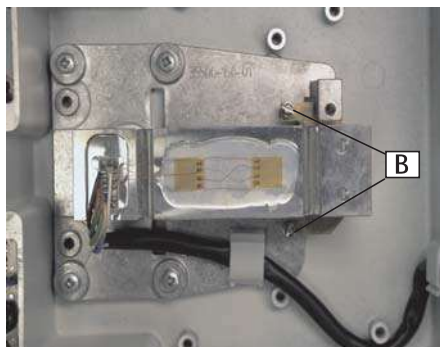

Überlast.tif

Adjust the two overload stop screws (B) so that a distance of about 0.1 mm (paper-thick) remains between the screws and the base plate when the maximum load plus around 10% is placed on the balance/scale.

Caution:

The overload stop screws (B) are not lock nuts. If ERR 02/03 appears during adjustment work, make that the overload stop screws are at the proper setting.

The offset adjustment adapts the weighing system to the internal A/D converter. You may need to adapt the A/D converter:

- after replacing the strain gauge measuring spring
- after replacing the main PCB
- when the sensitivity of the balance/scale cannot be adjusted (not even using the service software) and error code „Err 02“ is displayed.

There are two ways of adapting the converter:

1. with a digital voltmeter
2. using the service software (SARTOCAS, PSION Server)

1. Adapting the A/D Converter using a Digital Voltmeter:

- Open balance/scale
- Reconnect balance/scale to mains power
- Unload the weighing pan, use a digital voltmeter to measure IC6 Pin 6 against GND (see figure on the left)

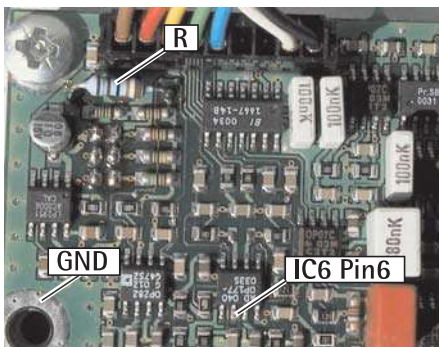

Aut_5027.jpg

Open the solder bridges and measure the ground at IC6 Pin 6. Depending on the voltage displayed, open or close the solder bridges in accordance with the chart (see next page). If the adjustment cannot be carried out through the solder bridges, an adjustment resistance (R, see figure left) determined with a decade resistor can be set when the solder bridges of the offset are open.

Caution!

The converter output must be within the range of the between -250 mV and -650 mV!

After replacing the main PCB, it may be necessary to transfer the existing adjustment resistance (R) to the new PCB.

Umeas (V) (solder bridges are open)	J1	J2	J3
-0.212...+0.153	Closed	Open	Open
+0.153...+0.518	Open	Closed	Open
+0.518...+0.883	Closed	Open	Closed
+0.883...+1.249	Closed	Closed	Closed

2. Adapting the A/D Converter Using the Service Software (SARTOCAS /PSION):

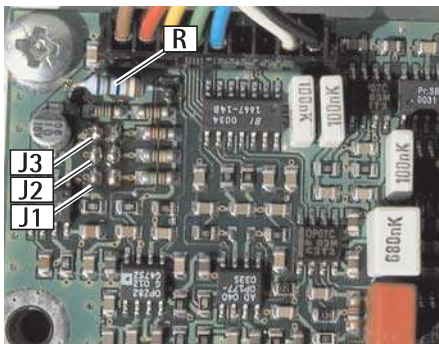

Aut_5027.jpg

- Activate the BPI Mode
- Use the service software in the „Diagnosis“ menu to check the output level (modulation) of the A/D converter

Caution!

Opening or closing solder bridges (J1 - J3) must change the converter output to within the range of 5% to 14%!

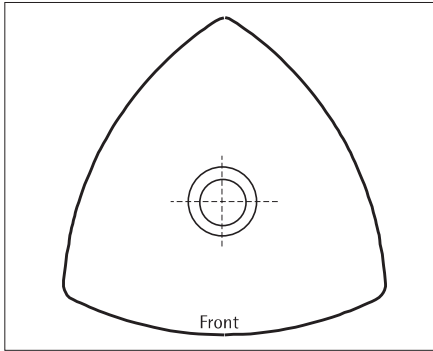

Eck_dr_3.eps

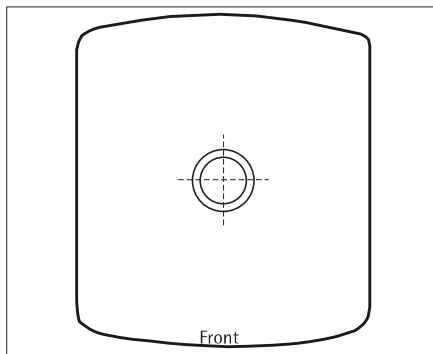

Eck_re_3.eps

Checking the Repeatability (Standard deviation)

- Select the test weight from the „Calibration/Adjustment Data Sheet“ (see pages 42-43).
- Unload the weighing pan and zero the balance/scale using the t key.
- Center the test weight on the weighing pan.
- Write down the weight displayed.
- Repeat the procedure five times.
- The repeatability is calculated from the 6 weighing operations as follows:

$$(\text{Max. value displayed} - \text{Min. value displayed}) / 3$$

- Compare the calculated value with the given tolerance.
- If the calculated value is not within the given tolerance, it may be due to one of the following reasons:
- The weighing system needs to be cleaned
- Mechanical parts are in the weighing system
- Bent / defective bending elements

Checking and Adjusting the Off-Center Loading Error

Caution:

Larger errors in the off-center loading error affect the repeatability of the weighing system!

The OIML Guideline R76-1 describes the tests for off-center loading tolerances for square, round and even triangular weighing pans. Therefore, the test weight should be placed on every 1/4 of the weighing pan surface.

The positions for placing test weights in triangular weighing pans are indicated in the figures to the left.

Please refer to the sketches to the left to establish the testing points for checking the off-center loading tolerances.

The markings should help you place the test weights in their proper positions.

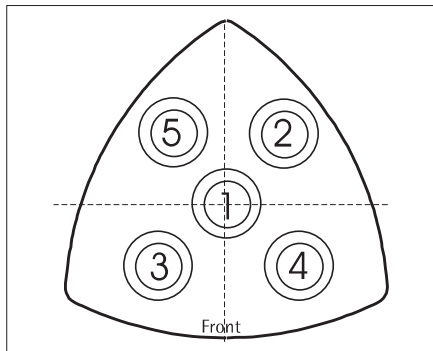

Eck_dr_2.eps

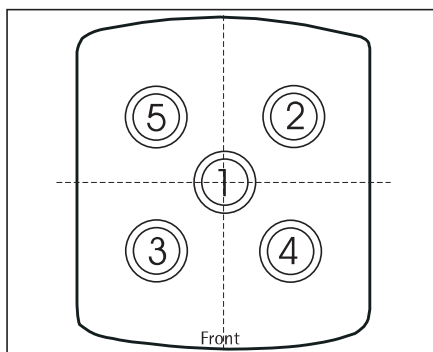

Eck_re_1.eps

Checking the Off-Center Loading Tolerances

Note: Select the test weights from the „Calibration/Adjustment Data Sheet (see pages 42-43).

CP Balances/Scales with Rectangular Weighing Pans

Models: CP622

- Place the test weight on position 1 on the weighing pan and zero the balance/scale by pressing the TARE key.
- In the order given, place the test weight in the position 2, 3, 4 and 5 as indicated and write down the readout at stability, including the plus/minus signs.
- If the off-center loading error is too large, adjust the balance so that the off-center loading error is within the tolerances specified.

CP Balances/Scales with Square Weighing Pans

Models: CP8201, CP6201, CP4201, CP2201, GP8201

- Compare the test weights with the tolerances listed in the „Calibration/Adjustment Data Sheet (see pages 42-43).
- If the off-center loading error is too large, adjust the balance so that the off-center loading error is within the tolerances specified.

Procedure for Adjusting the Off-Center Loading Error (Strain Gauge)

Note:

After calibration/adjustment of the off-center loading error, you must check the span and linearity and adjust as required.

On models CP2201, CP4201, CP6201, CP8201, GP8201, the off-center loading error should be adjusted by careful filing at appropriately thin places.

First, remove the weighing support. On subsequent models, this adjustment can be carried out through the long holes in the weighing pan support with an angled round file. It is then no longer necessary to remove the weighing pan support.

- Carry out the adjustment by careful filing at the positions described.
- Only file negative errors, preferably at the upper thin sites
- To avoid distorting the adjustment results on models with a higher resolution (60000 - 75000 increments), wait a few seconds after filing so that the thin sites can „cool down.“
- After each adjustment, recheck the off-center loading error, as the force parallelogram of the measuring spring will also change the error in the non-adjusted corners
- Check the off-center loading error once more after a longer period of time

1. Adjusting the Off-Center Loading Error: Front - Back

Negative error in the front:

(Captions: Weighing pan, right, left, front, back)

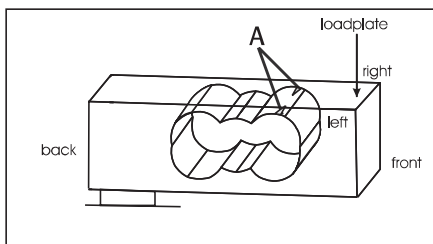

dms3ae.eps

- File the edges of the upper thin site evenly on the left and right, moving inwards. Small, inwardly tapering surfaces areas will be produced at the thin site „A“

Negative error in the back:

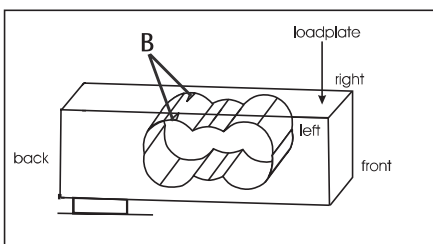

dms3be.eps

- File the edges of the upper thin site evenly on the left and right, moving inwards. Small, inwardly tapering surfaces areas will be produced at the thin site „B“

2. Adjusting the Off-Center Loading Error: Right - Left

Negative error on the right:

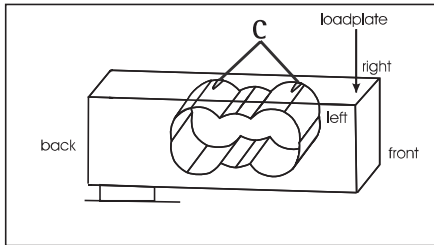

dms3ce.eps

- File the edges of the upper thin sites evenly on the front and back, moving inwards. Small, inwardly tapering surfaces areas will be produced at the thin sites „C“

Negative error on the left:

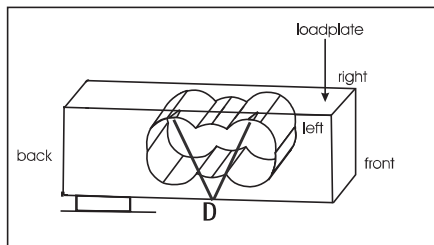

dms3de.eps

- File the edges of the upper thin sites evenly on the front and/or back, moving inwards. Small, inwardly tapering surfaces areas will be produced at the thin sites „D“

External Adjustment

Note: Before carrying out calibration/adjustment work, allow the balance/scale to warm up (between 30 min. and 24h, depending on the model)!
The external calibration/adjustment can be performed in various ways.

Only use calibrated weights!

1. As described in this manual
 2. or using the Sartorius MC1 Server (version 4.9 or later) or the SARTOCAS program for PCs and laptops.
- Make sure that the balance/scale operating menu is set to the code „1 9 1 - external calibration/adjustment accessible“ (see pages 13-14 „Operating Menu Settings“) or „1 9 7 - external adjustment/calibration/“, the Access Lock Switch has to be closed.



Anz_14-F.eps



Anz_25-F.eps



Anz_26-F.eps

- If necessary, tare the balance/scale by pressing the **TARE** key. Press **CAL** to activate the calibration/adjustment routine.

- The calibration weight required is displayed, (depending on the model, e.g. CP4201).

Caution!

The balance/scale only accepts a weight that is within a tolerance range of approx. 2% of the nominal value. Errors exceeding this tolerance range can only be corrected using the SARTORIUS MC1 Server Software.

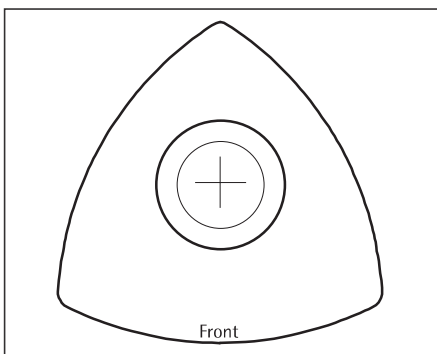

Waags_Just.eps

- Center the required weight (e.g. 2000g/F2) on the weighing pan and close the draft shield.
- After the calibration weight has been stored, the balance will return to the weighing mode.
- Menu »1 10 2 Calibration/Adjustment« calibration weight value will be displayed first, then press **CAL** key.

Adjusting External Linearity

Checking the Linearity

Note: The linearity must be checked according to the Standard Operating Procedure WKD-038.

- Check the linearity of the balance/scale for the entire weighing range in 4-g steps.
- Compare the values displayed with the tolerance ranges given in the „Table of Calibration/Adjustment Data“ on pages 42-43.
- If the errors exceed the permissible tolerance ranges, the linearity must be adjusted.

Adjusting the Linearity

Caution! You can adjust the linearity on CP balances/scales only using the SARTORIUS MC1 Server Software (Version 4.9 and later) or with the SARTOCAS program.

- Activate the BPI mode (see page 15).
- Adjust the linearity with the SARTORIUS MC1 Server (version 4.9 and later) or with the SARTOCAS program for PCs and laptops.
(Please see the program description for instructions on this automatic procedure!).

Testing and Adjustment Sequence on Balances/Scales with Double Lever Systems

Preparations:

Place the balance/scale on a solid, level surface that is free of vibration, e.g. a stone table. Level the balance/scale using the level indicator. Turn the balance/scale and allow it to warm up for about 30–60 minutes, depending on the model. Calibrate/adjust the balance/scale on this place.

Note:

Testing must be carried out according to the following Sartorius Standard Operating Procedure for Testing WKD-037-02 and WKD-038-02. They are also the equivalent of the given adjustment data as described in this service manual.

You will need to check and, if necessary, adjust the following:

1. Overload stop
2. Repeatability
3. Off-center loading error
4. Span adjustment
5. External linearity

Checking the Overload Stop

Note:

Overload stops no longer need to be checked on double lever systems.

Setting the Overload Stop

It is no longer necessary to set the overload stops. They are factory set and adjusted.

Checking the Repeatability (Standard deviation)

- Select the test weight from the „Adjustment Datasheet (see Page 42–43).
- Unload the weighing pan and zero the balance/scale using the **TARE** key.
- Center the test weight on the weighing pan.
- Write down the weight displayed.
- Repeat the procedure five times.
- The repeatability is calculated from the 6 weighing operations as follows:

$$(\text{Max. value displayed} - \text{Min. value displayed}) / 3$$

- Compare the calculated value with the given tolerance.
- If the calculated value is not within the given tolerance, it may be due to one of the following reasons:

- The weighing system needs to be cleaned
- Mechanical parts are in the weighing system
- Bent / defective bending elements

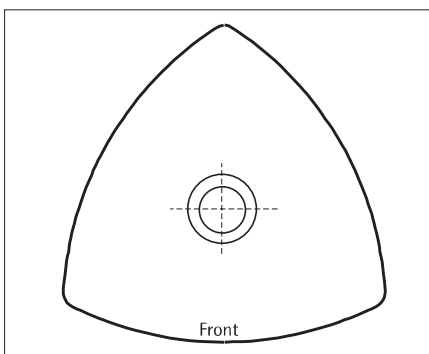

Eck_dr_3.eps

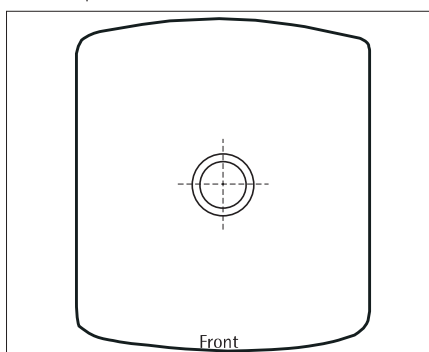

Eck_re_3.eps

Checking and Adjusting the Off-Center Loading Error

Caution:

Larger errors in the off-center loading error affect the repeatability of the weighing system!

The OIML Guideline R76-1 describes the tests for off-center loading tolerances for square, round and even triangular weighing pans. Therefore, the test weight should be placed on every 1/4 of the weighing pan surface.

The positions for placing test weights in triangular weighing pans are indicated in the figures to the left.

Please refer to the sketches to the left to establish the testing points for checking the off-center loading tolerances.

The markings should help you place the test weights in their proper positions.

Checking the Off-Center Loading Tolerances

Note: The data for the test weight and the tolerance are listed in the „Adjustment Datasheet (see Page 42-43).

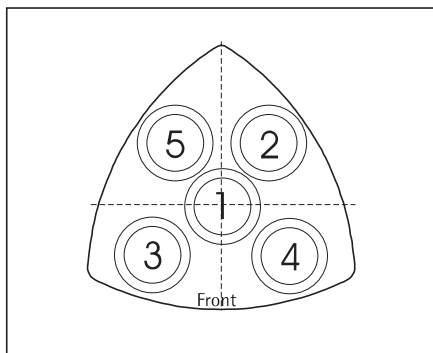

Eck_dr_wh1.eps

CP Balances/Scales with Draft Shields and Triangular Weighing Pans

Models: CP423S, CP323S, CP323P, CP153, GC2502

- Place the test weight on position 1 on the weighing pan and zero the balance/scale by pressing the **TARE** key.
- In the order given, place the test weight in the position 2, 3, 4 and 5 as indicated and write down the readout at stability, including the plus/minus signs.
- If the off-center loading error is too large, adjust the balance so that the off-center loading error is within the tolerances specified.

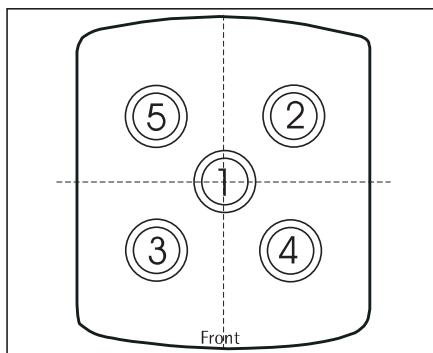

Eck_re_2.eps

CP Balances/Scales with Square Weighing Pan

Models: CP4202S, CP3202S, CP3202P, CP2202S, CP5202, GP3202

- Compare the off-center loading errors with the tolerances listed in the („Adjustment Datasheet“ see Page 42-43).
- If the off-center loading error is too large, adjust the balance so that the off-center loading error is within the tolerances specified.

Procedure for Adjusting the Off-Center Loading Error (Double Lever System)

Note: After calibration/adjustment of the off-center loading error, you must check the span and linearity and adjust as required.

On models CP4202S, CP3202S, CP3202P, CP2202S, GP5202, GP3202, CP153, CP323S, CP323P, CP423S, GC2502, the off-center loading error should be adjusted by careful filing at appropriately thin places on the upper guide. To avoid distorting the adjustment, wait a few seconds after filing so that the thin sites can „cool down“.

Caution! After carefully removing the housing, adjust the off-center loading error only at the thin sites in the back using an angled file. Check the off-center loading error and adjust the largest error first by carefully filing at these points (see figures on the left and below).

The errors measured (see the section „Off-Center Loading Error“) refer to the position of the systems in the balance/scale.

Position of the Systems in the Balance/Scale

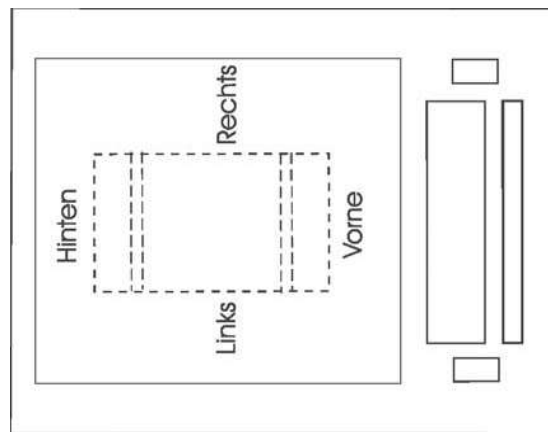

CP1d.tif

← front view

Off-center loading error:

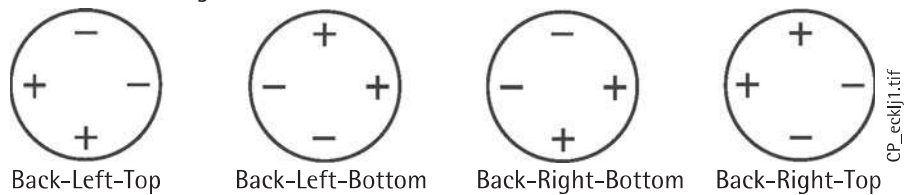

CP_eckj1.tif

← front view

Side view of the system

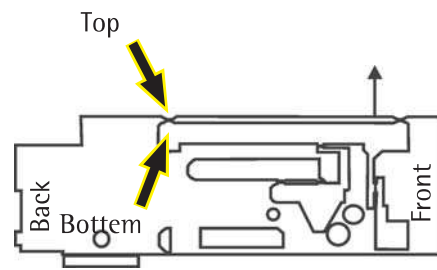

winkh.tif

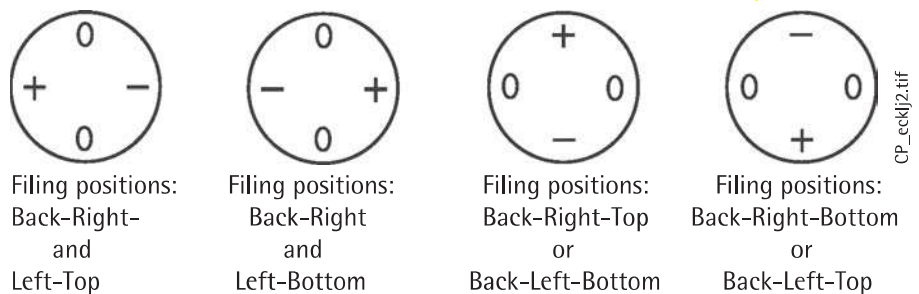

CP_eckj2.tif

← front view

Filing positions: Back-Right- and Left-Top Filing positions: Back-Right and Left-Bottom Filing positions: Back-Right-Top or Back-Left-Bottom Filing positions: Back-Right-Bottom or Back-Left-Top

Note:

External Adjustment

Before carrying out calibration/adjustment work, allow the balance/scale to warm up properly!

The external calibration/adjustment can be performed in various ways.

Only use calibrated weights!

1. As described in this manual,
2. or using the Sartorius MC1 Server (Version 4.4) or later) or the SARTOCAS program for PCs and laptops).
 - Make sure that the balance/scale operating menu is set to the code „1 9 1 - e external calibration/adjustment accessible“ (see Page 13-14 „ Operating Menu Settings“) or „1 9 7 - external adjustment/calibration/“, the Access Lock Switch has to be closed.



Anz_14-F.eps

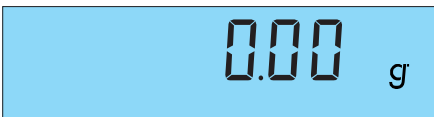

Anz_27-F.eps



Anz_28-F.eps

- If necessary, tare the balance/scale by pressing the **TARE** key. Press **CAL** to activate the calibration/adjustment routine.

- The calibration weight required is displayed, (depending on the model, e.g. CP4202S).

Caution!

The balance/scale only accepts a weight that is within a tolerance range of approx. 2% of the nominal value. Errors exceeding this tolerance range can only be corrected using the SARTORIUS MC1 Server Software.

CP Balances/Scales with Draft Shields and Triangular Weighing Pans

Models: CP423S, CP323S, CP323P, CP153, GC2502

- Center the required weight (e.g. 200g/E2 depending on the model, e.g. CP423S) on the weighing pan and close the draft shield.
- After the calibration weight has been stored, the balance will return to the weighing mode.
- Menu »1 10 2 Calibration/Adjustment« calibration weight value will be displayed first, then press **CAL** key.

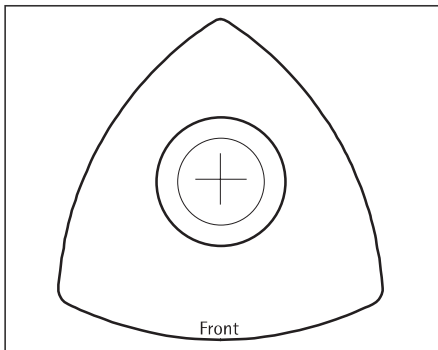

Waags_Just.eps

CP Balances/Scales with Square Weighing Pan

Models: CP4202S, CP3202S, CP3202P, CP2202S, CP5202, GP3202

- Center the required weight (e.g. 2000g/E2 depending on the model, e.g. CP4202S) on the weighing pan.
- After the calibration weight has been stored, the balance will return to the weighing mode.
- Menu »1 10 2 Calibration/Adjustment« calibration weight value will be displayed first, then press **CAL** key.

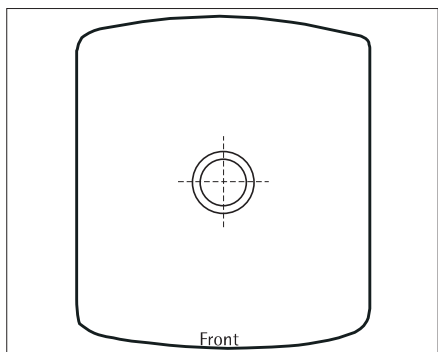

Eck_re_3.eps

Adjusting External Linearity

Checking the Linearity

Note:

The linearity must be checked according to the Standard Operating Procedure WKD-038.

- Check the linearity of the balance/scale for the entire weighing range in 4-g steps.
- Compare the values displayed with the tolerance ranges given in the „Table of Adjustment Data“ Page 42-43.
- If the errors exceed the permissible tolerance ranges, the linearity must be adjusted.

Adjusting the Linearity

Caution!

You can adjust the linearity on CP balances/scales only using the SARTORIUS MC1 Server Software (Version 4.9 and later) or with the SARTOCAS program.

- Activate the BPI mode (see Page 15).
- Adjust the linearity with the SARTORIUS MC1 Server (Version 4.9 and later) or with the SARTOCAS program for PCs and laptops.
(Please see the program description for instructions on this automatic procedure!).

Testing and Adjustment Sequence on Balances/Scales with Monolithic Weighing Systems

Preparations:

Place the analytical balance on a solid, level surface that is free of vibration, e.g. a stone table. Level the analytical balance using the level indicator. Turn the balance/scale and allow it to warm up for about 4h-24h.

Note:

Testing must be carried out according to the following Sartorius Standard Operating Procedure for Testing WKD-037-02 and WKD-038-02. They are also the equivalent of the given adjustment data as described in this service manual.

You will need to check and, if necessary, adjust the following:

1. Overload stop
2. Repeatability
3. Off-center loading error
4. Span adjustment
 - External span adjustment
 - Overwrite internal calibration weight
 - Internal span adjustment
5. Linearity
 - External linearization
 - Overwrite internal linearity weight

Checking the Overload Stop

Note:

Overload stops no longer need to be checked monolithic weigh cells.

Setting the Overload Stop

It is no longer necessary to set the overload stops. They are factory set and adjusted.

Checking the Repeatability (Standard deviation)

- Select the test weight from the „Adjustment Datasheet (see Page 42-43).
- Unload the weighing pan and zero the balance/scale using the t key.
- Center the test weight on the weighing pan.
- Write down the weight displayed.
- Repeat the procedure five times.
- The repeatability is calculated from the 6 weighing operations as follows:

$$(\text{Max. value displayed} - \text{Min. value displayed}) / 3$$

- Compare the calculated value with the given tolerance. If the calculated value is not within the given tolerance, it may be due to one of the following reasons:

- The weighing system needs to be cleaned
- Mechanical parts are in the weighing system
- Bent / defective bending elements

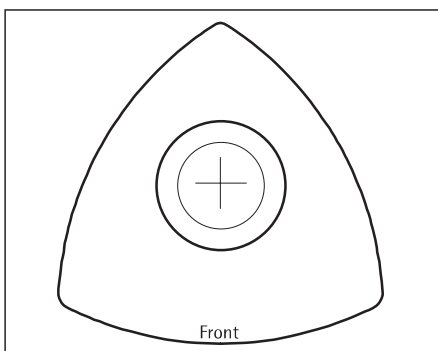

Waags_Just.eps

Checking and Adjusting the Off-Center Loading Error

Caution:

Larger errors in the off-center loading error affect the repeatability of the weighing system!

The OIML Guideline R76-1 describes the tests for off-center loading tolerances for square, round and even triangular weighing pans. Therefore, the test weight should be placed on every 1/4 of the weighing pan surface.

The positions for placing test weights in triangular weighing pans are indicated in the figures to the left.

Please refer to the sketches to the left to establish the testing points for checking the off-center loading tolerances.

The markings should help you place the test weights in their proper positions.

Note:

Checking the Off-Center Loading Tolerances

The data for the test weight and the tolerance are listed in the „Adjustment Datasheet (see Page 42-43).

CP Semimicro-Balances with Rectangular Weighing Pans

Models: CP225D, CP324S, CP224S, CP124S, CP64, GC1603, GC803S, GC803P

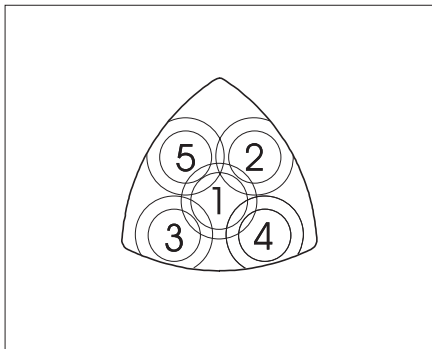

Eck_dr_mo3.eps

- Place the test weight on position 1 on the weighing pan and zero the balance/ scale by pressing the **TARE** key.
- In the order given, place the test weight in the position 2, 3, 4 and 5 as indicated and write down the readout at stability, including the plus/minus signs.
- If the off-center loading error is too large, adjust the balance so that the off-center loading error is within the tolerances specified.

Adjusting the Off-Center Loading Error (Monolithic System)

Off-center loading errors are determined by carrying out a 3-point adjustment. The 3-point adjustment shows the greatest possible off-center loading error on the balance/scale.

Note:

You have to open the balance/scale for calibration/adjustment of the off-center loading error.

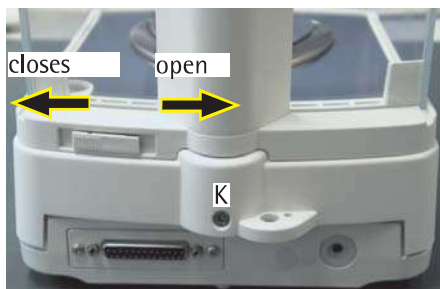

winds.jpg

- Remove the weighing pan and draft shield ring
- Open the draft shield cover and carefully remove the draft shield
- Remove the Seal of Warranty on the back panel of the balance/scale and the loosen the thumbscrew (K)
- First, move the top part of the balance/scale to the back and then carefully lift upwards
- Replace the weighing pan

Note:

In the future, two openings in the top part of the balance/scale will make it unnecessary to remove the housing.

3-Point Adjustment

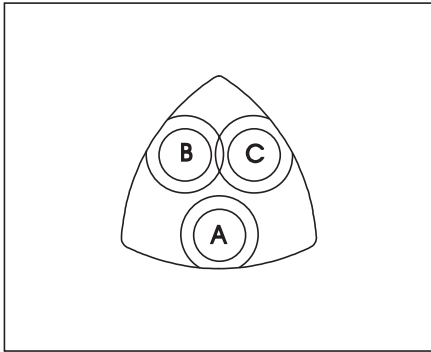



Eck_dr_mo2.eps

- During calibration/adjustment of the off-center loading error, the system must be covered over.
- To adjust the off-center loading error, change the settings of the off-center load thumbscrews.
- Place the test weight in position A on the weighing pan and zero the balance/scale by pressing t.
- In the order given, place the test weight in the position B and C and write down the readout at stability

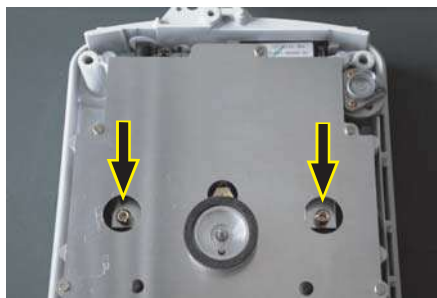
- Example:	Position A	 key	0.0000 g
	Position B		+ 0.0005 g
	Position C		- 0.0004 g



AUT_5201.jpg

- Only adjust the side with the greatest error (in the amount), taking into account:
 - Negative errors
Turn the off-center load thumbscrews inwards  (clockwise)
 - Positive errors
Turn off-center load thumbscrews outwards  (counterclockwise)
- Adjust the thumbscrew by small turns and then recheck the off-center loading error at positions A-C
- Repeat this procedure until the off-center loading error is within 3 points of the tolerance range.

Note:

After adjusting the off-center loading error, you must also check and, if necessary, adjust the linearity and span on the balance/scale.

Caution!

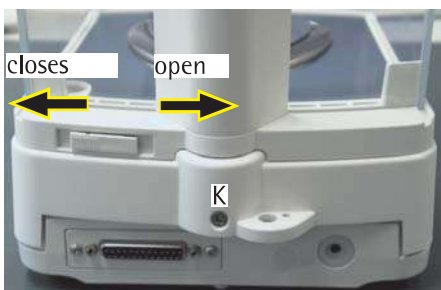

winds.jpg

During assembly, be careful not to damage the internal data cable!

- Insert the upper part of the balance/scale (tilting it slightly) so that the two retainers (under the keypad) lock into the two screws (in the front part of the bottom of balance/scale)
- Slide the upper part of the balance/scale carefully to the front and then push down gently
- Fasten the housing by tightening screw (K) and affix the Seal of Warranty
- Open the draft shield cover
- Place the draft shield on the balance/scale, align by eye, press down on the draft shield gently from above and close the cover
- Replace the draft shield ring and weighing pan

Note:



Anz_14-F.eps



Anz_15-F.eps



Anz_16-F.eps

External Adjustment

The external calibration/adjustment can be performed in various ways.

Only use calibrated weights!

1. As described in this manual,
 2. or using the Sartorius MC1 Server (Version 4.9 or later) or the SARTOCAS program for PCs and laptops).
- Make sure that the balance/scale operating menu is set to the code „1 9 1 - external calibration/adjustment accessible“ (see pages 13-14 „Operating Menu Settings“) or „1 9 7 - external adjustment/calibration/“, the Access Lock Switch has to be closed.

- If necessary, tare the balance/scale by pressing the **TARE** key. Press **CAL** to activate the calibration/adjustment routine.

- The calibration weight required is displayed, (depending on the model, e.g. CP225D).

Caution!

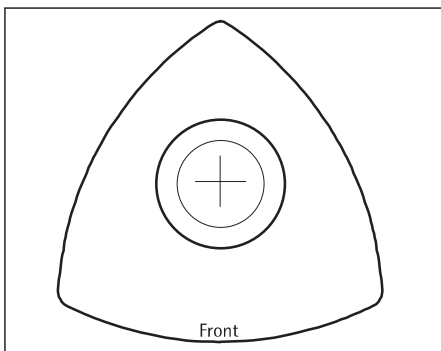

Waags_Just.eps

The balance/scale only accepts a weight that is within a tolerance range of approx. 2% of the nominal value. Errors exceeding this tolerance range can only be corrected using the SARTORIUS MC1 Server Software.

- Center the required weight (e.g. 200g/E1) on the weighing pan and close the draft shield.
- After the calibration weight has been stored, the balance will return to the weighing mode.
- Menu »1 10 2 Calibration/Adjustment« calibration weight value will be displayed first, then press **CAL** key.

Overwriting the Internal Calibration Weight

Caution!

The internal calibration weight on CP balances/scales should only be overwritten using the PSION Server or the SARTOCAS program for PCs and laptops, since the factory setting of the internal calibration weight is highly accurate. Only in the case of emergency (e.g. no service software available) should you perform the overwrite protection using the balance's overwrite program).

Important:

Before carrying out the overwriting internal calibration weight, you must correctly adjust the span.

The balance/scale must warm up for at least 4 - 24 hours!

Note:

There are various ways of overwriting the internal calibration weight on CP balances/scales.

1. As described in this manual
2. or using the Sartorius MC1 Server (Version 4.9 or later) or the SARTOCAS program for PCs and laptops).



Anz_09-F.eps

- Make sure that the balance/scale operating menu is set to the code „1 9 3 - internal calibration/adjustment accessible „ (see Page 13-14 „ Operating Menu Settings „).

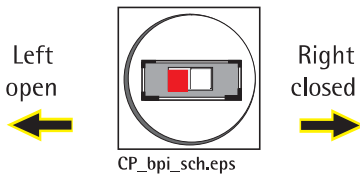

- Slide the access lock switch to the left. It is accessible via an opening on the back of the balance/scale.
- If you have done so already, perform external calibration/adjustment (see Page 31).
- Turn off the balance/scale by pressing I/O .

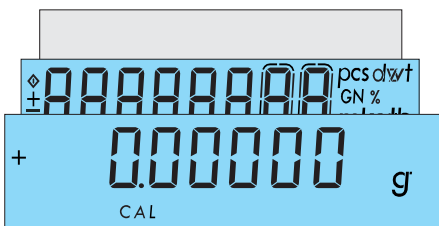

Anz_10-F.eps

- Turn the balance/scale back on by pressing I/O and while simultaneously holding down the CAL key until the readout shown on the left appears.
- Press the TARE key to tare the balance/scale; then press CAL to activate the „overwrite internal calibration weight“ function.



Anz_19-F.eps

- The built-in, motorized internal calibration weight is applied, then removed automatically; the weight value is overwritten; and the balance/scale returns to the normal weighing mode.



Anz_20-F.eps

- Press the CAL key to check the external span adjustment once again.

Internal Span Adjustment



Anz_09-F.eps

- Make sure that the menu code „1 9 3 - internal calibration/adjustment accessible“ is set (see Page 13 -14 Operating Menu Settings).
- Press the TARE key to tare the balance/scale; then press CAL to activate the calibration/adjustment function..



Anz_20-F.eps

- The built-in, motorized internal calibration weight is applied, then removed automatically; the weight value is overwritten; and the balance/scale returns to the normal weighing mode.



Anz_19-F.eps

- Slide the access lock switch back to the right. Replace the capped plug to close the opening.

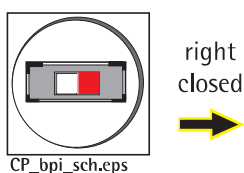

Linearity

Checking the Linearity

Note:

The linearity must be checked according to the Standard Operating Procedure WKD-038.

- Check the linearity of the balance/scale for the entire weighing range in 50-g steps.
- Compare the values displayed with the tolerance ranges given in the „Table of Calibration/Adjustment Data“ on pages 42–43.
- If the errors exceed the permissible tolerance ranges, the linearity must be adjusted.





Adjusting the Linearity

Caution!

You can adjust the linearity on CP balances/scales only using the SARTORIUS MC1 Server Software (Version 4.9 and later) or with the SARTOCAS program.

- Activate the BPI mode (see page 15).
- Adjust the linearity with the SARTORIUS MC1 Server (Version 4.9 and later) or with the SARTOCAS program (Version 1.44 or later) for PCs and laptops. (Please see the program description for instructions on this procedure!).

Alternative manual procedure:

- When using the operating menu, make sure that the code „1 9 5 -external linearization accessible“ is set (refer to page 13–14 „Operating Menu Settings“).
- Switch on the balance/scale using the  key.
- If necessary, press  to tare the balance/scale.
- Press the  key until the display on the left appears.
- Place the required weight on the weighing pan.
If the required weight is within $\pm 2\%$ of the tolerance range of the displayed value the plus sign will go out. If not, the minus sign will appear. Errors that are too large can be adjusted only with PSION or PC!
- Remove the weight and, if necessary, press the  key to tare the balance.
- Repeat this procedure until you are prompted to unload the balance.
- After the zero point value has been stored, the balance/scale will return to the standard weighing mode.



Anz_09-F.eps

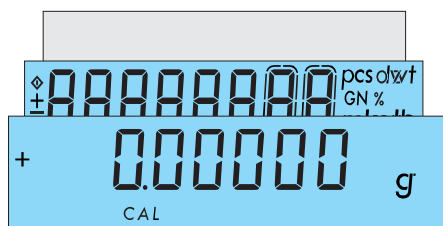

Anz_10-F.eps



Anz_11-F.eps

Caution!

After working in the BPI mode, make sure to set the write-protect again so that the balance/scale returns to the standard data record output mode (SBI mode = Sartorius Balance Interface) and peripheral devices can be connected.

Note:

(SBI mode = Sartorius Balance Interface Mode)
(BPI mode = Binary Processor Interface Mode)

Overwriting the Internal Linearization Weight

The factory setting of the internal linearization weights is highly accurate:

- If overwriting these weights is necessary, this indicates a mechanical or electrical error!
- The balance/scale must be allowed to warm up (6 hours)!

Note:

There are various ways of overwriting the internal calibration weight on CP balances/scales.

1. As described in this manual
2. or using the Sartorius MC1 Server (Version 4.9 or later)
3. or with the SARTOCAS Program (Version 1.44 or later) for PCs and laptops.



Anz_12-F.eps

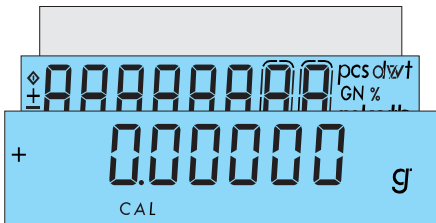

Anz_10-F.eps

- Make sure that the balance/scale operating menu is set to the code „1 9 6 -internal linearization accessible" (see page 13-14 „Operating Menu Settings“).
- If you have not done so already, perform external linearization/adjustment.
- Slide the access lock switch to the right. It is accessible via an opening on the back of the balance/scale.
- Turn the balance/scale back on by pressing I/O and then press the CAL key until the readout shown on the left appears.
- Press the TARE key to tare the balance/scale; then press CAL to activate the overwrite function.

- The built-in, motorized internal linearization weights are applied, then removed automatically; the weight value is stored in the EEPROM of the processor; and the balance/scale returns to the normal weighing mode.

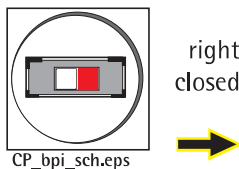

- After completing the linearization routine, reset the code „1 9 6" to „1 9 3" and slide the access lock switch to the left (menu locked). Replace the capped plug to close the opening.

Testing and Adjustment Sequence on Balances/Scales with Forked Lever Systems

Preparations:

Place the balance/scale on a solid, level surface that is free of vibration, e.g. a stone table. Level the balance/scale using the level indicator. Turn the balance/scale and allow it to warm up for about 30–60 minutes, depending on the model.

Calibrate/adjust the balance/scale on this place.

Note:

Testing must be carried out according to the following Sartorius Standard Operating Procedure for Testing WKD-037-02. They are also equivalent to the given adjustment data as described in this service manual.

You will need to check and, if necessary, adjust the following:

1. Overload stop
2. Repeatability
3. Off-center loading error
4. Span adjustment
5. External linearity

Checking the Overload Stops

Note:

Overload stops no longer need to be checked on forked lever systems.

Setting the Overload Stops

The overload stops no longer need to be set. They are factory set and calibrated.

Checking the Repeatability (Standard Deviation)

- Select the test weight from the „Calibration/Adjustment Data Sheet“ (see pages 42–43).
- Unload the weighing pan and zero the balance/scale using the t key.
- Center the test weight on the weighing pan.
- Write down the weight displayed.
- Repeat the procedure five times.
- The repeatability is calculated from the 6 weighing operations as follows:

$$(\text{Max. value displayed} - \text{Min. value displayed}) / 3$$

- Compare the calculated value with the given tolerance.
- If the calculated value is not within the given tolerance, it may be due to one of the following reasons:
 - The weighing system needs to be cleaned
 - Mechanical parts are in the weighing system
 - Bent / defective bending elements

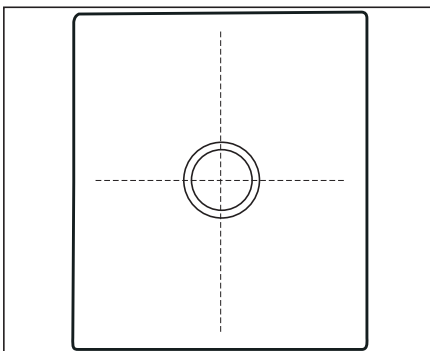

Eck_re_G3.eps

Checking and Adjusting the Off-Center Loading Tolerances

Caution:

Deviations in off-center loading tolerances affect the repeatability of the weighing system!

The OIML Guideline R76-1 describes the tests for off-center loading tolerances for square, round and even triangular weighing pans. Therefore, the test weight should be placed on every 1/4 of the weighing pan surface.

The positions for placing test weights in triangular weighing pans are indicated in the figures to the left.

Please refer to the sketches to the left to establish the testing points for checking the off-center loading tolerances.

The markings should help you place the test weights in their proper positions.

Checking the Off-Center Loading Tolerances

Note:

Select the test weight from the „Calibration/Adjustment Data Sheet (see pages 42-43).

CP balances/scales with square weighing pans (300x400mm)

Models: CP12001S, CP16001S, CP34000, GP34000P, CP34001S

- Place the test weight on position 1 on the weighing pan and zero the balance/ scale by pressing the **TARE** key.
- In the order given, place the test weight in the position 2, 3, 4 and 5 as indicated and write down the readout at stability, including the plus/minus signs.
- If the off-center loading error is too large, adjust the balance so that the off-center loading error is within the tolerances specified.

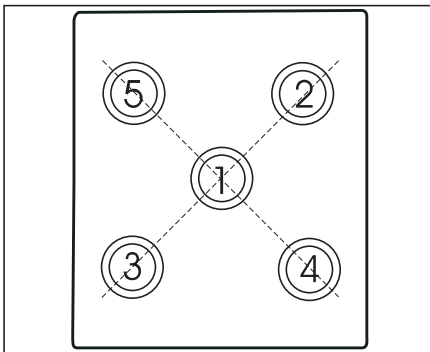

Eck_re_G2.eps

Adjusting the Off-Center Loading Error

Off-center loading errors should be adjusted by careful filing at appropriately thin places on the upper guide. To avoid distorting the adjustment, wait a few seconds after filing so that the thin sites can „cool down.“

Caution!

After carefully remove the housing, adjust the off-center loading error only at the thin sites in the back and front using an angled file. Check off-center loading error and adjust the largest error first by carefully filing (see figures).

The measured errors (see the section „Off-Center Loading Error“) refer to the system positions in balance/scale!

Position of systems in the balance/scale

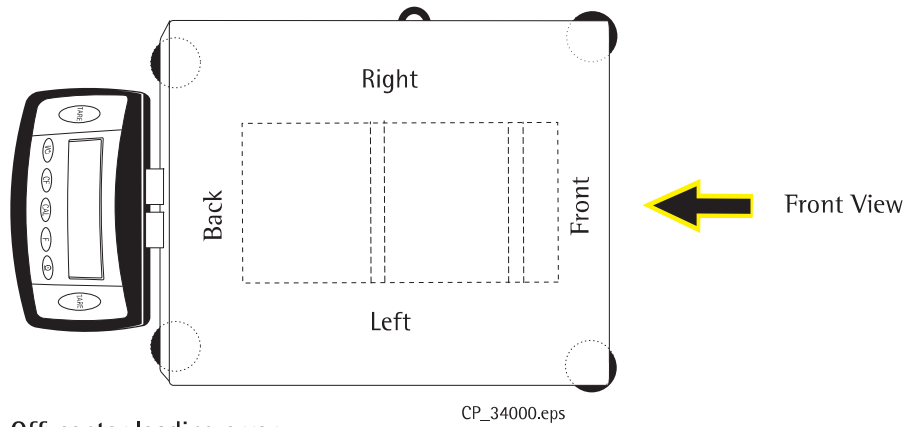

Off-center loading error:

Side view of the system

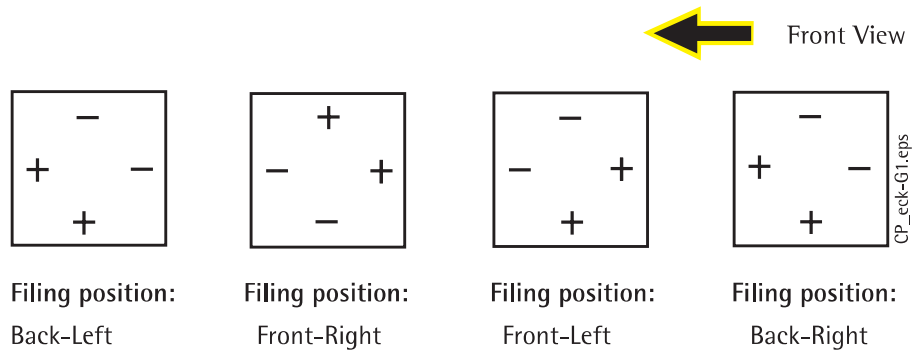
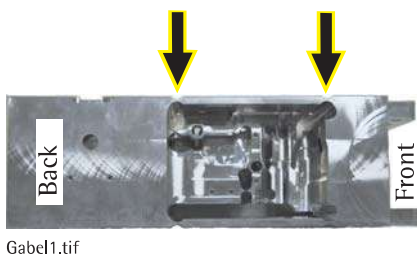

Off-center loading error:

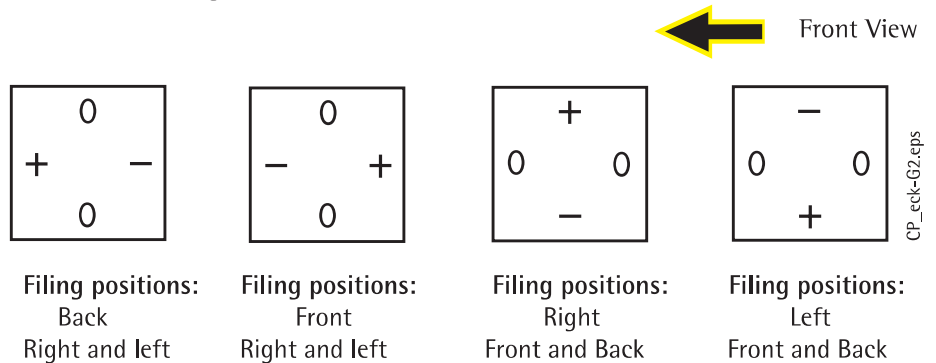

Note:



Anz_14-F.eps

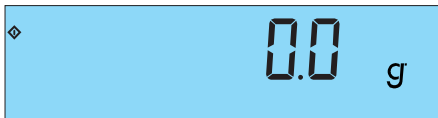

Anz_23-F.eps



Anz_24-F.eps

Caution!

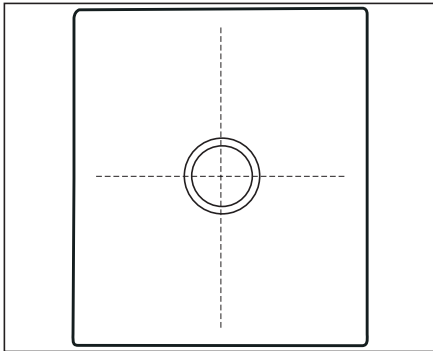

Eck_re_G3.eps

External Adjustment

The external calibration/adjustment can be performed in various ways.

Only use calibrated weights!

1. As described in this manual,
 2. or using the Sartorius MC1 Server (version 4.9 or later) or the SARTOCAS program for PCs and laptops.
- Make sure that the balance/scale operating menu is set to the code „1 9 1 - external calibration/adjustment accessible“ (see pages 13-14 „Operating Menu Settings“) or „1 9 7 - external adjustment/calibration/“, the Access Lock Switch has to be closed.

- If necessary, tare the balance/scale by pressing the **TARE** key. Press **CAL** to activate the calibration/adjustment routine.

- The calibration weight required is displayed, (depending on the model, e.g. CP34001S).

The balance/scale only accepts a weight that is within a tolerance range of approx. 2% of the nominal value. Errors exceeding this tolerance range can only be corrected using the SARTORIUS MC1 Server Software.

- Center the required weight (e.g. 10 kg/F1) on the weighing pan and close the draft shield.
- After the calibration weight has been stored, the balance will return to the weighing mode.
- Menu »1 10 2 Calibration/Adjustment« calibration weight value will be displayed first, then press **CAL** key.

Adjusting External Linearity

Checking the Linearity

Note:

The linearity must be checked according to the Standard Operating Procedure WKD-038.

- Check the linearity of the balance/scale for the entire weighing range in 4-g steps.
- Compare the values displayed with the tolerance ranges given in the „Table of Calibration/Adjustment Data“ on pages 42-43.
- If the errors exceed the permissible tolerance ranges, the linearity must be adjusted.

Adjusting the Linearity

Caution!

You can adjust the linearity on these balances/scales only using the SARTORIUS MC1 Server Software (Version 4.9 and later) or with the SARTOCAS program (Version 1.44 and later).

- Activate the BPI mode (see Page 15).
- Adjust the linearity with the SARTORIUS MC1 Server (Version 4.9 and later) or with the SARTOCAS program for PCs and laptops. (Please see the program description for instructions on this automatic procedure!).

Error Code	Explanation	Remedial Measures
Err 01	Display format overflow, i.e., the value to be output cannot be shown on the display.	Reset the balance operating menu with menu code »9 -- 1 «, "Accessing the Balance Menu."
Err 02	Zero point error at the start of the calibration/ adjustment function; caused by operating error (balance not tared, or still loaded), or stability was not reached, or by a deviation of the zero point (adjust the preload).	First make sure there was no operating error. If the balance still cannot be calibrated/adjusted, you must follow the procedure in "Adjusting the Preload"; then perform "External Calibration/Adjustment."
Err 06	Internal calibration weight defective or not present.	Check the calibration weight operating system and, if necessary, exchange the main PCB. With balances check the menu code settings. The codes »1 9 3 « and »1 9 4 « should be blanked out, otherwise, overwrite these codes with the SARTORIUS MC1Server 4.9.
Err 10	"Tare" key is blocked, with data in the tare 2 memory. (only for the application "2nd tare memory")	The tare functions are interlocked; once the data in the tare 2 memory has been deleted, the tare key will be accessible again.
Err 11	Invalid data; cannot be stored in the tare 2 memory.	The display value you tried to store is negative. Check the load on the balance (tare container).
Err 22	Reference value in the counting or weighing in percent application not permissible; cannot be stored.	The weight of the reference sample is too low, or the displayed value is negative. Check the load on the balance (reference sample).
Err 30	The print key was pressed, or an external print command (" <code><ESC> P</code> ") was given, while the balance was in the BPI mode.	Set the balance back to SBI; this can be done using the SARTORIUS MC1 Server 4.9.
Err 50	Temperature compensation (TC) converter error; value measured by the TC circuit exceeds the tolerance range.	Perform TC compensation using the MC1 Server. If this does not suffice, proceed as described under » ERR 53 «.
Err 53	Temperature compensation (TC) converter not functioning; no value transmitted to the balance processor from the TC circuit.	Check the TC sensors, the main PCB and the connection between the two. If necessary, proceed as directed in "Exchanging the Main PCB," or replace the TC sensors.
Err 54	The balance converter value of the A/D converter is below the lower limit; the value measured by the A/D converter is too low, or no value is measured.	Check the weighing system, the main PCB and the connection between the two. If necessary, proceed as directed in "Exchanging the Main PCB," or see „Repairing the Weighing System."
Err 55	The balance converter value of the A/D converter is above the upper limit; the value measured by the A/D converter is too high.	Check the weighing system, the main PCB and the connection between the two. If necessary, proceed as directed in "Exchanging the Main PCB."

Error Code	Explanation	Remedial Measures
Err 220	ROM checksum error; the data in the internal ROM of the balance processor (AOC) are incorrect.	Follow the procedure in "Exchanging the Main PCB."
Err 230	RAM read/write error; the data in the internal RAM of the balance processor AOC is incorrect, or not possible.	Follow the procedure in "Exchanging the Main PCB."
Err 237	EEPROM checksum error in the linearity range; the balance has not yet been linearized, or the data in the internal EEPROM of the balance processor AOC are incorrect.	Overwrite the incorrect data record using the MC1 Server 4.9. Then proceed as directed in „Adjusting the Linearity" and "External Calibration."
Err 239	EEPROM checksum error in the linearity weight range; the stored factor for the linearity weight is not within the permissible tolerance range or is incorrect.	Follow the procedure for "Overwriting the Internal Linearity Weight."
Err 241	EEPROM checksum error in the permanent area; the data for the balance operating menu in the internal EEPROM of the balance processor AOC are incorrect.	Overwrite the incorrect data record using the MC1 Server 4.9. If the error remains, then proceed with "Exchanging the Main PCB."
Err 243	EEPROM checksum error in the menu range; the inalterable data in the internal EEPROM of the balance processor AOC are incorrect.	With the menu access switch unlocked, access the menu (display will flash). Exit the menu and store (press the tare key for more than 2 sec.) => The menu is now reset. Checksums are corrected.
Err 245	EEPROM checksum error in the calibration/adjustment range (zero point); the balance has not yet been calibrated or the data in the internal EEPROM of the balance processor AOC are incorrect.	Perform "External Calibration/Adjustment."
Err 247	EEPROM checksum error in the adjustment/calibration range (span); the balance has not yet been calibrated or the data in the internal EEPROM of the balance processor AOC are incorrect.	Perform "External Calibration/Adjustment."
Err 249	EEPROM checksum error in the calibration weight range; the factor stored for the internal weight calibration exceeds the tolerance range, or is incorrect.	Follow the procedure for "Overwriting the Internal Calibration Weight."
L	The weight on the pan is below the weighing capacity; the pan is not on the balance, the balance was incorrectly adjusted or the preload was incorrectly adjusted.	Make sure there was no operating error. If the error remains, perform "External Calibration/Adjustment" or follow the procedure for "Adjusting the Preload."
H	The weight on the pan exceeds the weighing capacity; the weight is too heavy; the balance was incorrectly adjusted; or the preload was incorrectly adjusted.	Make sure there was no operating error. If the error remains, perform "External Calibration/Adjustment" or follow the procedure for "Adjusting the Preload."

Only valid in compliance with the "Metrological Test Procedure" specified in the Standard Operating Procedures WKD-037 and WKD-038

Model	Weighing-capacity		Readability		Reproducibility		Off-center load Eccentricity		TCE	iso CAL				
					Test weight	Permissible tolerance (s)	Test weight	Permissible tolerance (±)	ppm/K	K				
CP124S	121	g	0.1	mg	100	g	0.1	mg	100	g	0.4	mg	1.2	n
CP224S	220	g	0.1	mg	200	g	0.1	mg	100	g	0.3	mg	1.2	n
CP225D	80/210	g	0,01/0,1	mg	50	g	0.02	mg	120	g	0.2	mg	1	n
CP12001S	12000	g	0.1	g	10000	g	0.1	g	5000	g	0.3	g	2	n
CP153	150	g	0.001	g	100	g	0.001	g	100	g	0.003	g	1.8	n
CP16001S	16	kg	0.1	g	10000	g	0.2	g	5000	g	0.3	g	2	n
CP2201	2200	g	0.1	g	2000	g	0.05	g	2000	g	0.2	g	2	n
CP2202S	2200	g	0.01	g	2000	g	0.01	g	1000	g	0.03	g	2	n
CP3202P	800/1600/ 3200	g	0,01/0,02/ 0,05	g	500	g	0.01	g	1000	g	0.04	g	1.8	n
CP3202S	3200	g	0.01	g	2000	g	0.01	g	2000	g	0.06	g	2	n
CP323P	80/160 320	g	0,001/0,002 0,005	g	50	g	0.001	g	200	g	0.005	g	1.8	n
CP323S	320	g	0.001	g	200	g	0.002	g	200	g	0.005	g	1.8	n
CP34000	34	kg	1	g	10000	g	1	g	10000	g	2	g	2	n
CP34001P	8/16/34	kg	0,1/0,2/0,5	g	7000	g	0.1	g	10000	g	0,6	g	4	n
CP34001S	34	kg	0.1	g	10000	g	0.1	g	10000	g	0,5	g	2	n
CP4201	4200	g	0.1	g	2000	g	0.05	g	2000	g	0.3	g	4	n
CP4202S	4200	g	0.01	g	2000	g	0.01	g	2000	g	0.04	g	1.6	n
CP423S	420	g	0.001	g	200	g	0.001	g	200	g	0.006	g	2	n
CP6201	6200	g	0.1	g	5000	g	0.05	g	2000	g	0.3	g	4	n
CP622	620	g	0.01	g	500	g	0.01	g	500	g	0.03	g	4	n
CP64	64	g	0.1	mg	50	g	0.1	mg	50	g	0.4	mg	1.2	n
CP8201	8200	g	0.1	g	2000	g	0.07	g	3000	g	0.3	g	4	n
GP3202	3200	g	0.01	g	2000	g	0.01	g	2000	g	0.06	g	2	n
GP5202	5200	g	0.01	g	2000	g	0.02	g	2000	g	0.04	g	3	n
GP8201	8200	g	0.1	g	2000	g	0.07	g	3000	g	0.3	g	4	n
GC2502	2500	ct	0.01	ct	200	g	0.01	ct	200	g	0.04	ct	2	n
GC1603P	800/1600	ct	0,001/0,1	ct	100	g	0.001	ct	100	g	0.002	ct	1	n
GC803S	800	ct	0.001	ct	100	g	0.001	ct	100	g	0.003	ct	1.2	n

Only valid in compliance with the "Metrological Test Procedure" specified in the Standard Operating Procedures WKD-037 and WKD-038

Model	Class	Kennwertgenauigkeit			Linearity		
		Adjustm. weight	Test weight	Permissible tolerance (±)	Tareweight	Testweight	Permissible tolerance (±)
CP124S	E2	intern	100 g	0.3 mg	30/60/100 g	20 g	0.2 mg
CP224S	E2	intern	200 g	0.4 mg	50/100/150 g	50 g	0.2 mg
CP225D	E2	intern	70/200 g	0,15/0,4 mg	50/100/150 g	10/50 g	0,03/0,2 mg
CP12001S	F1	10000 g	12000 g	0.2 g	(5000) g	3000/6000/8000/12000 g	0.2 g
CP153	F1	100 g	150 g	0.003 g	(50) g	30/70/110 g	0.002 g
CP16001S	F2	10000 g	15000 g	3 g	(5000) g	4000/8000/12000/16000 g	0.2 g
CP2201	F2	2000 g	2000 g	0.1 g	(1000) g	500/1000/1500/2000 g	0.1 g
CP2202S	E2	2000 g	2000 g	0.02 g	(1000) g	500/1000/1500/2000 g	0.02 g
CP3202P	F1	1000 g	3000 g	0.03 g	700/1500/2200 g	600 g	0.02 g
CP3202S	F1	2000 g	3000 g	0.03 g	(1000) g	700/1500/2200/3000 g	0.02 g
CP323P	F1	100 g	300 g	0.005 g	70/150/220 g	60 g	0.002 g
CP323S	F1	200 g	300 g	0.003 g	(100) g	70/150/220/3000 g	0.002 g
CP34000	F1	10000 g	32000 g	2 g	(10000) g	7000/15000/22000/30000 g	2 g
CP34001P	F1	10000 g	32000 g	1 g	7000/15000/25000 g	7000 g	0.2 g
CP34001S	F1	10000 g	32000 g	0.5 g	(10000) g	7000/15000/22000/30000 g	0.2 g
CP4201	F2	2000 g	4000 g	0.3 g	(2000) g	1000/2000/3000/4000 g	0.1 g
CP4202S	E2	2000 g	4000 g	0.03 g	(2000) g	1000/2000/3000/4000 g	0.02 g
CP423S	E2	200 g	400 g	0.002 g	(200) g	100/200/300/400 g	0.002 g
CP6201	F1	5000 g	5000 g	0.1 g	(2000) g	1500/3000/4000/6000 g	0.1 g
CP622	F1	500 g	500 g	0.01 g	(200) g	150/300/400/600 g	0.01 g
CP64	E2	intern	60 g	0.3 mg	(20) g	15/30/40/60 g	0.2 mg
CP8201	F1	5000 g	8000 g	0.2 g	(3000) g	2000/4000/6000/8000 g	0.1 g
GP3202	F1	2000 g	3000 g	0.03 g	(1000) g	700/1500/2200/3000 g	0.02 g
GP5202	E2	5000 g	5000 g	0.02 g	(2000) g	1000/2500/4000/5000 g	0.02 g
GP8201	F1	5000 g	8000 g	0.2 g	(3000) g	2000/4000/6000/8000 g	0.1 g
GC2502	E2	500 g	500 g	0.02 ct	(200) g	100/250/400/500 g	0.02 ct
GC1603P	E2	intern	300 g	0.01 ct	70/150/220 g	70 g	0.002 ct
GC803S	E2	intern	150 g	0.002 ct	(50) g	30/60/100/150 g	0.001 ct
GC803P	E2	intern	150 g	0.01 ct	30/60/100 g	50 g	0.001 ct

Only valid in compliance with the „Metrological Test Procedure“ specified in the Standard Operating Procedures WKD-037 and WKD-038

Model	Weighing capacity		Readability		Reproducibility		Off-center load Eccentricity		Span accuracy				Linearity														
	Test weight	Permissible tolerances	Test weight	Permissible tolerances	Test weight	Permissible tolerances	Test weight	Permissible tolerances (±)	Class	Adjustm. weight	Test weight	Permissible tolerance (±)	Tareweight	Testweight	Permissible tolerance (±)												
CP26P	5 21	g	0.002 0.01	mg	20	g	0.004	mg		20	g	0.006 0.06	mg	1/5/10/20	g	20	g	0.008 0.03	mg								
CPA225D	40 80 210	g	0.01 0.01	mg	50	g	0.02 0.05 0.1	mg		120	g	0.2	mg	E2	intern	80 200	g	0.15 0.4	mg	10/20/30 50/100/150	g	10 50	g	0.03 0.1 0.2	mg		
CPA324S	320	g	0.1	mg	200	g	0.1	mg		200	g	0.4	mg	E2	intern	200	g	0.4	mg	70/150/250	g	50	g	0.3	mg		
CPA224S	220	g	0.1	mg	200	g	0.1	mg		100	g	0.3	mg	E2	intern	200	g	0.4	mg	50/100/150	g	50	g	0.2	mg		
CPA124S	120	g	0.1	g	100	g	0.1	mg		100	g	0.4	mg	E2	intern	100	g	0.3	mg	30/60/100	g	20	g	0.2	mg		
CPA64	64	g	0.1	mg	50	g	0.1	mg		50	g	0.4	mg	E2	intern	60	g	0.3	mg	—	15/30/40/60	g	—	0.2	mg		
CPA64-WDS	64	g	0.1	mg	50	g	0.1	mg		50	g	0.4	mg	E2	intern	60	g	0.3	mg	—	15/30/40/60	g	—	0.2	mg		
CPA1003S	1010	g	0.001	g	500	g	0.001	g		500	g	0.004	g	E2	1000	g	1000	g	0.004	g	—	200/400/ 600/800	g	—	0.1	g	
CPA1003P	500 1010	g	0.001 0.01	g	400	g	0.001	g		1000	g	0.04	g	E2	intern	1000	g	0.01	g	200/500/ 800	g	200	g	—	0.02	g	
CPA623S	620	g	0.001	g	200	g	0.001	g		200	g	0.004	g	E2	500	g	500	g	0.002	g	—	150/300/400/ 600	g	—	0.002	g	
CPA423S CPA423S-DS	420	g	0.001	g	200	g	0.001	g		200	g	0.006	g	F1	200	g	400	g	0.002	g	—	100/200/300/ 400	g	—	0.002	g	
CPA323S	320	g	0.001	g	200	g	0.002	g		200	g	0.005	g	F1	200	g	300	g	0.003	g	—	70/150/ 220/300	g	—	0.002	g	
CAP223S	220	g	0.001	g	200	g	0.001	g		200	g	0.003	g	F1	200	g	220	g	0.003	g	—	30/70/110	g	—	0.002	g	
CPA6202S	6200	g	0.01	g	2000	g	0.01	g		2000	g	0.04	g	E2	5000	g	5000	g	0.04	g	—	1500/3000/4 000/6000	g	—	0.02	g	
CPA6202P	1500 3000 6200	g	0.01 0.02 0.05	g	1000	g	0.01	g		1000	g	0.06	g	F1	5000	g	5000	g	0.05	g	1500/3000/4 000	g	1500	g	—	0.02	g
CPA5202S-DS	5200	g	0.01	g	5000	g	0.01	g		2000	g	0.04	g	E2	intern	5000	g	0.02	g	—	1200/2500/4 000/5000	g	—	0.01	g		
CPA4202S	4200	g	0.01	g	2000	g	0.01	g		2000	g	0.06	g	E2	4000	g	4000	g	0.04	g	—	1000/2000/ 3000/4000	g	—	0.02	g	
CPA3202S	3200	g	0.01	g	2000	g	0.01	g		2000	g	0.06	g	F1	2000	g	3000	g	0.03	g	—	700/1500/ 2200/3000	g	—	0.02	g	
CPA2202S CPA2202S-DS	2200	g	0.01	mg	2000	g	0.01	g		1000	g	0.03	g	E2	2000	g	2000	g	0.02	g	—	500/1000/ 1500/2000	g	—	0.02	g	
CPA10001	10000	g	0.1	g	5000	g	0.1	g		5000	g	0.4	g	F1	5000	g	10000	g	0.2	g	—	2000/4000/ 6000/8000	g	—	0.2	g	
CPA8201	8200	g	0.1	g	5000	g	0.1	g		5000	g	0.3	g	F2	5000	g	8000	g	0.2	g	—	2000/4000/ /6000/8000	g	—	0.2	g	
CPA5201	5200	g	0.1	g	5000	g	0.1	g		2000	g	0.4	g	F1	5000	g	5000	g	0.2	g	—	1200/2500/ 4000/5000	g	—	0.1	g	
CPA34001S	34	kg	0.1	g	10000	g	0.1	g		10000	g	1	g	F1	10000	g	32000	g	0.5	g	—	7000/15000/ 22000/30000	g	—	0.3	g	
CPA34001P	8 16 34	kg	0.1 0.2 0.5	g	5000	g	0.1	g		10000	g	1	g	F2	10000	g	30000	g	1	g	7000/15000 25000	g	7000	g	—	0.3	g
CPA16001S	16	kg	0.1	g	10000	g	0.1	g		5000	g	0.5	g	F1	intern	15000	g	0.3	g	—	4000/8000/1 2000/16000	g	—	0.2	g		
CPA12001S	12000	g	0.1	mg	10000	g	0.1	g		5000	g	0.3	g	F1	5000	g	10000	g	0.2	g	—	3000/6000/ 8000/12000	g	—	0.2	g	
CPA34000	34	kg	1	g	10000	g	1	g		10000	g	2	g	F2	10000	g	30000	g	1	g	—	7000/15000/ 22000/30000	g	—	1	g	

Template for Off-Center Loading (CP622)

CPA5202S-DS, CPA2202S-DS

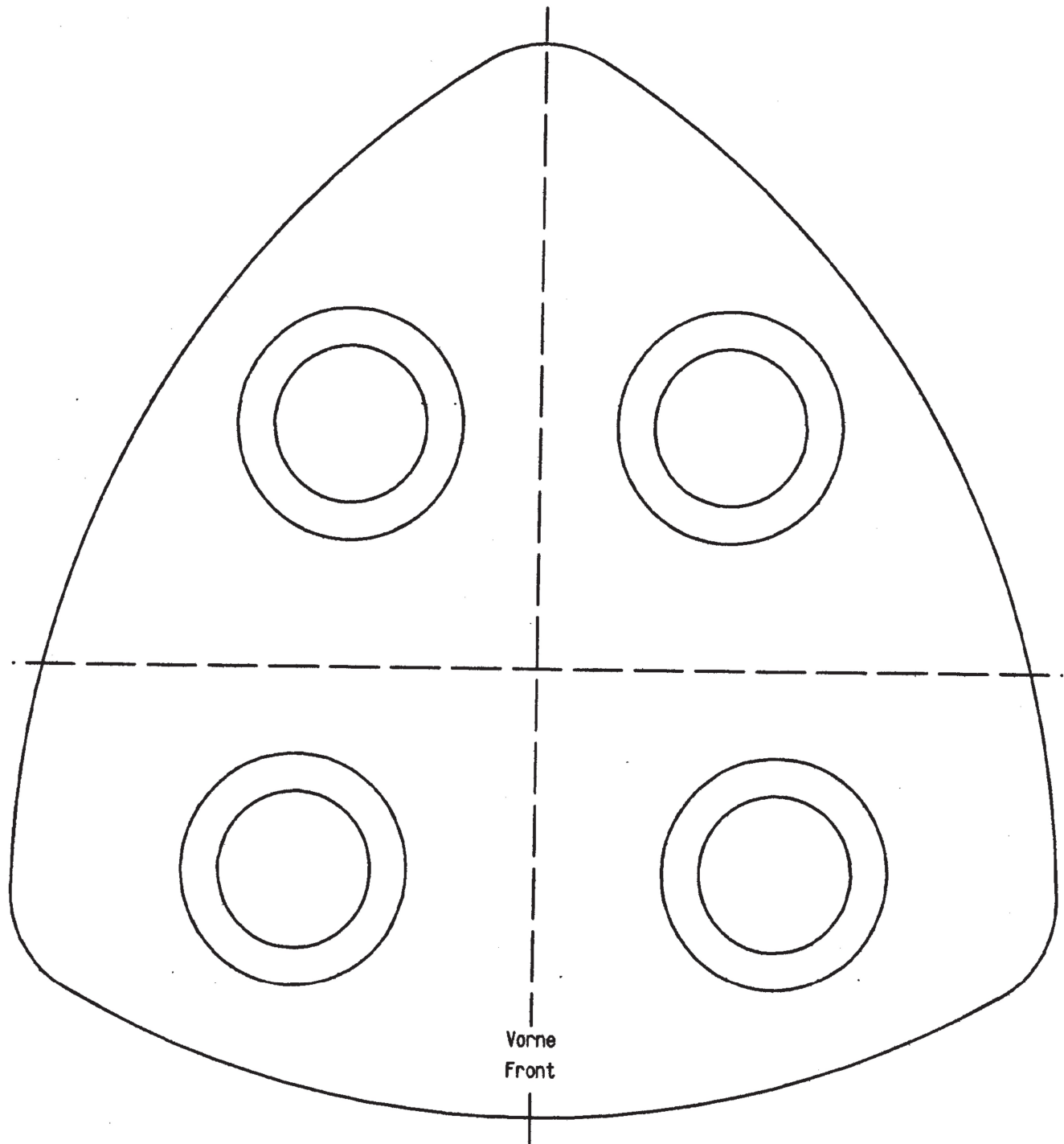

Maßstab 1:1

Template for Off-Center Loading
CP153, CP323P, CP323S, CP423S
CPA1003S, CPA623S, CPA423S, CPA323S, CPA223S

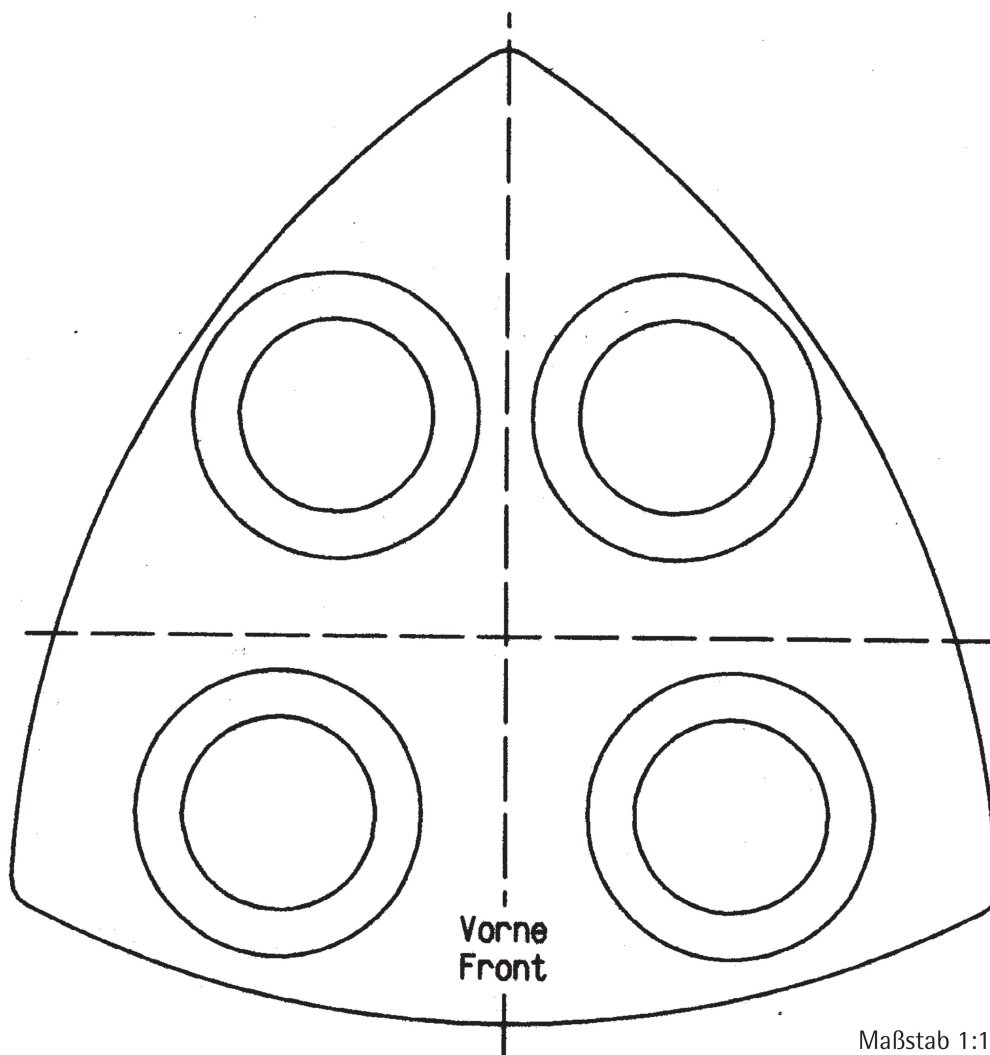

Template for Checking the Off-Center Loading
CP64, CP124S, CP224S, CP225D, CP324S, GC803S, GC803P, GC1603
CPA64, CPA124S, CPA224S, CPA225D, CPA324S

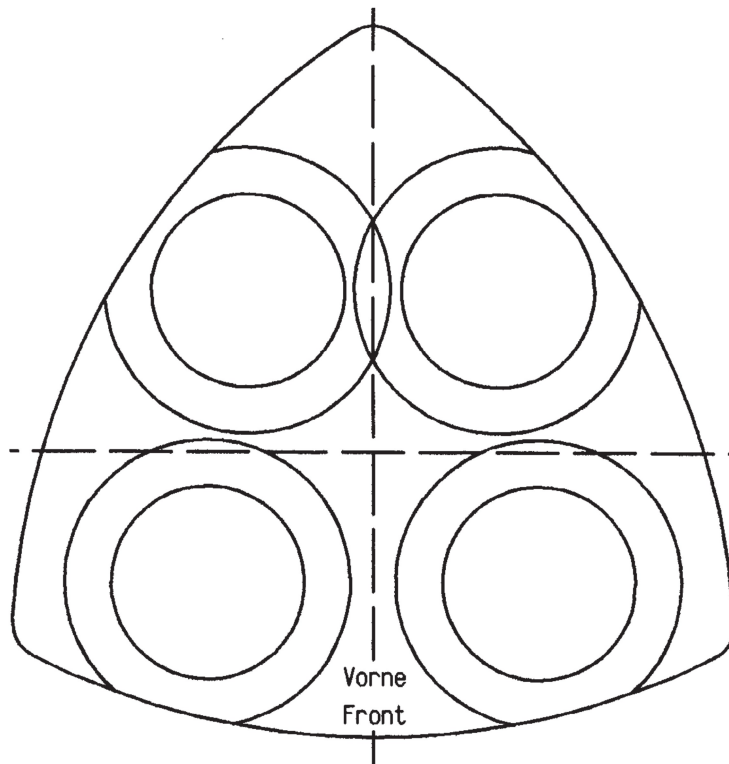

Maßstab 1:1

Sartorius AG
Weender Landstrasse 94-108
37075 Goettingen, Germany

Hotline (+49/5 51) 308-4440
Fax (+49/5 51) 308-4449
Internet: www.sartorius.com
E-mail: Int.Service@Sartorius.com

Copyright by Sartorius AG, Goettingen, Germany.
All rights reserved. No part of this publication
may be reprinted or translated in any form or by any means
without the prior written permission of Sartorius AG.

The status of the information, specifications and illustrations
in this manual is indicated by the date given below.
Sartorius AG reserves the right to make changes to the
technology, features, specifications, and design
of the equipment without notice.

Status: October 2007, Sartorius AG, Goettingen, Germany

Printed in Germany on paper that has been
bleached without any use of chlorine · I.K. · KT
Publication No.: WCP5001-e07104