



OPERATING TABLES





ALVO operating tables have been designed for all kinds of surgical operations and treatments. The wide range of additional equipment ensures optimal table configuration and safe positioning of patients during all surgical procedures. Ease-of-use, versatility and optimised access to the operating area increase working ergonomics for the surgical team. High quality and proven technology of ALVO operating tables guarantee the patients' safety.

Intelligent electronics significantly facilitate control and increase accuracy of table positioning. The ALVO mechanic and hydraulic operating tables are based on highest quality, technical solutions from the world leading micro-hydraulics providers.



PATIENT SAFETY



Highest quality of ALVO operating tables is ensured by use of the best solutions from world leading manufacturer of medical hydraulic systems.

Benefits for surgeons:
operating tables
ensures comfortable access
and optimal patient
positioning

Safe, antistatic mattresses are made of soft polyurethane to ensure the required antistatic properties and tightness. Additionally, the mattresses can be covered with antimicrobial coatings.



Wide range of table tops and possible configurations of the table, as well as wide portfolio of accessories helps to fulfill requirements of the most demanding surgeons.

Benefits for
anaesthesiologist:
optimal access
to anaesthesia equipment
and monitors

ALVO surgical tables can be controlled with use of standard wire remote controller or optional wireless remote controller, optional foot switch, side panels as well as alternative drive and ALVO Integra wall panel. Wide range of proposed solutions helps our customers to control movements of our tables in most comfortable way possible.



STAFF WORKING ERGONOMICS

Intelligent electronic control system enables smooth movements and precision of adjustments. Energy management as well as low consumption during movements ensure long working time on batteries. Electric system is equipped with internal charger, which shortens battery charging time to the minimum.



Benefits for nurses:
mobility of the bases
as well as smooth and
easy-going mechanism
makes work of the
medical personnel
easier and faster

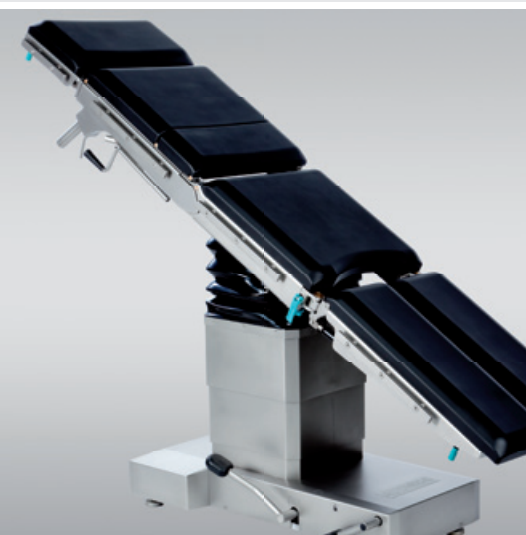

In electro - hydraulic tables the movements of selected sections of table top and column are performed hydraulically, which significantly relieves medical staff, making patient positioning easier.



Benefits for radiologist:
ALVO operating tables
are equipped with
radiotranslucent table
tops to ensure comfortable
work during X-ray
procedures directly
in the OR.



The new carbon fibre table top enables intra-operative imaging during surgery without transporting the patient to the radiology lab.

ALVO operating tables can be controlled via **ALVO INTEGRA** system, increasing comfort and improving ergonomics, limiting the time needed to prepare the room for surgery and allowing precise and safe patient positioning anytime.



ALVO Integra - complete integration of the following devices in the OR:

OPERATING TABLES

OPERATING LIGHTS

GENERAL LIGHTING

DOORS

ALVO Integra

Complete integration of all devices
and advanced imaging.



VIDEO CONFERENCE SYSTEM

AUDIO & VIDEO SOURCE

CAMERAS

AIR-CONDITIONING

ALVO OPERATING TABLES

OPERATING TABLES

ALVO PRELUDIUM 4-01

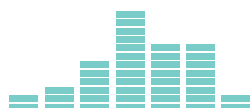

ALVO ETIUDA 4-02



ALVO SERENADA 4-04



ALVO RAPSODIA 4-05

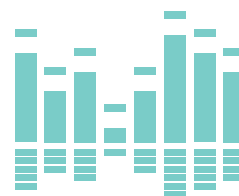

TREATMENT TABLES

ALVO MENUET 4-00



OR TABLE SYSTEM

ALVO SONATA 4-03



SPECIAL TABLES

ALVO SERENADA-C
with carbon-fibre table top



OPERATING TABLES



Table top sections
are X-ray translucent

High class **antistatic polyurethane mattresses**
available with antimicrobial hygiene function based on silver ions

Side rails enable assembly of various additional equipment

Multi-sectional tabletop enables exchanging the segments or longitudinal shift

ALVO PRELUDIUM 4-01

Operating table ALVO PRELUDIUM 4-01 has been designed to support the patient during all surgical procedures and interventions: general surgery, vascular surgery, endoscopy, neurosurgery, gynecology, urology and orthopedic procedures.

ALVO Preludium 4-01 is a hydraulic-mechanical, mobile operating table made of stainless, acid-proof steel, with sectional table top and mobile base equipped with mechanical central brake. Standard version offers vertical adjustment provided from hydraulic system driven by a foot pump. Lateral tilts and body elevator adjustment is performed by crank mechanism. Other functional movements - longitudinal tilts and table top sections adjustments are gas spring supported. Second, customized version of Preludium table offers all three movements of the column (height, trend, side tilts adjustments) driven from the foot pump.

Two available versions of a mechanical-hydraulic system used for driving the table column, helps to fulfill customer requirements and make this cost attractive and reliable OT even more attractive.



Technical parameters ALVO PRELUDIUM 4-01

Total length of the table with table top: - 4, 5-section - 6-section - orthopedic/orthopedic attachment	2100 mm 2200 mm 2000-3300 mm	Foot rest abduction	max 180°
Table top width	500 mm	Lateral tilts adjustment	±25° (±30°)*
Total table top width	560 mm	Head rest adjustment	±45°
Height adjustment with mattress (tables with longitudinal shift)	800-1050 mm*	Elevation of the kidney bench (option)	~120 mm
Height adjustment with mattress (tables without longitudinal shift)	730-1030 mm	Longitudinal shift (option)	300 mm*
Height adjustment with supermobile base (with big castors)	730-980 mm	Trendelenburg \ reverse-Trendelenburg	±30° (±35°)*
Back rest adjustment	+85° ÷ -45°	Table mass	230 kg
Foot rest adjustment	+20° ÷ -90°	Max. dynamic load capacity	200 kg** 250 kg***
		Lifetime	10 years

* also available

** permissible load in reversed orientation of the table top: 135 kg

*** option

OPERATING TABLES



Table top sections are X-ray translucent

High class antistatic polyurethane mattresses available with antimicrobial hygiene function based on silver ions

Side rails enable assembly of various additional equipment

Base available with central lock

ALVO ETIUDA 4-02

ALVO ETIUDA 4-02 has been designed to support the patient during all surgical procedures and interventions: general surgery, vascular surgery, endoscopy, neurosurgery, gynecology, urology and orthopedic procedures.

ALVO Etiuda 4-02 is an electro-hydraulic, mobile operating table made of stainless, acid proof steel. The table can be equipped with wide range of table tops and bases. Functional movements of the table column are provided by reliable electro-hydraulic system. Movements of the table top are supported with gas springs, longitudinal shift is equipped with mechanical brake. Multi-sectional table top allows to reverse the orientation of the sections.

Good working parameters and wide customization options make ALVO Etiuda 4-02 a great way to enter the world of electrohydraulic tables.

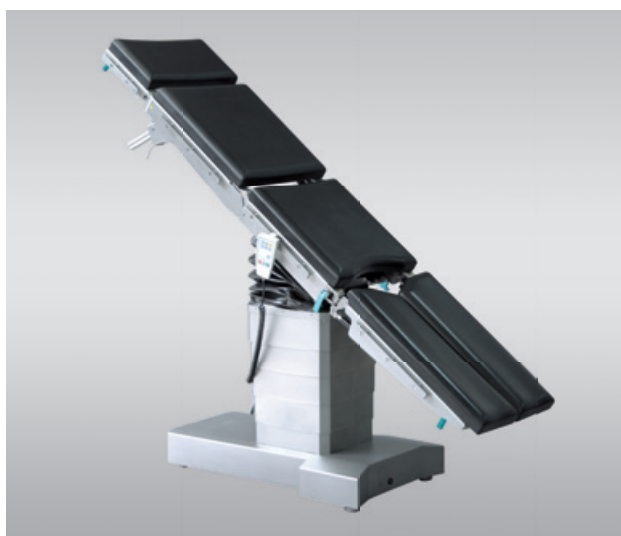

Technical parameters ALVO ETIUDA 4-02

Total length of the table with table top:	
– 4, 5-section	2100 mm
– 6-section	2200 mm
– orthopedic/orthopedic attachment	2000-3300 mm
Table top width	500 mm
Total table top width	560 mm
Height adjustment with mattress (tables with longitudinal shift)	750-1080 mm
Height adjustment with supermobile base (with big castors)	750-1080 mm
Height adjustment with mattress, 2-grade column	665-1115 mm
Height adjustment with flat base	730-1060 mm
Back rest adjustment	+85° ÷ -45°
Foot rest adjustment	+20° ÷ -90°
Foot rest abduction	max 180°
Lateral tilts adjustment	±30°
Head rest adjustment	±45°
Elevation of the kidney bench (option)	~120 mm

Longitudinal shift	300 mm
Trendelenburg / reverse-Trendelenburg	±40°
Table mass	240 kg
Max. dynamic load capacity	225 kg* 250 kg**
Max. static load capacity (over base)	275 kg
Power supply	24 V
Batteries (sealed, maintenance-free)	12 V, 7 Ah, 2 pieces
Battery charging time	< 12 h
Working time between battery charging	about 60 operations
Work character	interrupted operation 2/18 min
Battery charger	built-in
Charger power	230 V ~50/60 Hz
Power consumption from mains (max.)	1,5 A/230 V
Lifetime	10 years
International Protection Marking	IP-X4
IEC protection class	I
Application part type	B

* permissible load in reversed orientation of the table top: 140 kg

** option

OPERATING TABLES



Table top sections are X-ray translucent

High class **antistatic polyurethane mattresses** available with antimicrobial hygiene function based on silver ions

Side rails enable assembly of various additional equipment

Base available with **central lock** or optionally with **electrohydraulic lock** controlled with **remote control**

ALVO SERENADA 4-04

ALVO SERENADA 4-04 has been designed to support the patient during all surgical procedures and interventions: general surgery, vascular surgery, endoscopy, neurosurgery, gynecology, urology and orthopedic procedures.

ALVO Serenada 4-04 is an electro-hydraulic, mobile operating table made of stainless, acid proof steel. The table can be equipped with wide range of table tops and bases. Functional movements of the table column are provided by reliable electro-hydraulic system. Movements of the back section and kidney bench are performed electro-hydraulically, leg rest and footrest are supported on the gas springs. Longitudinal shift is equipped with mechanical brake. Multi-sectional table top allows to reverse the orientation of the sections. ALVO Serenada 4-04 offers also modular table top with short back section for better access to the shoulder area.

ALVO Serenada 4-04 with its higher load capacity, variety of electro-hydraulic driven movements and wide working parameters is a flexible and comfortable, well balanced offer for modern OR.

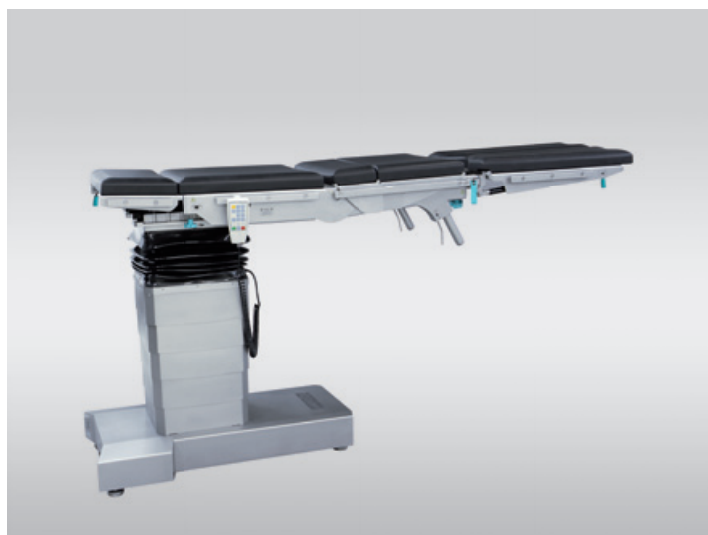
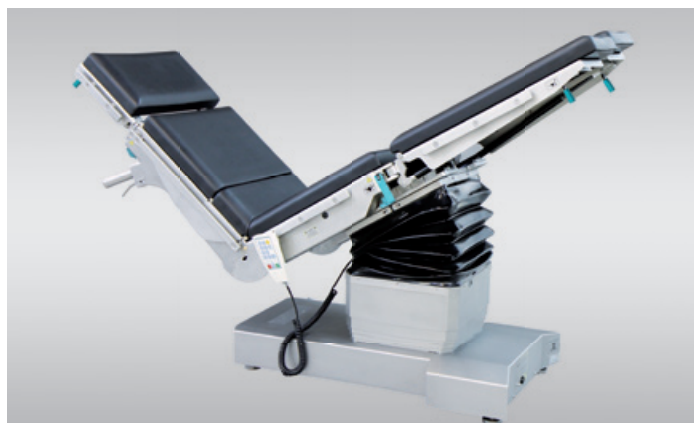

Technical parameters ALVO Serenada 4-04

Total length of the table with table top:			
- modular	2100-2250 mm*	Max. dynamic load capacity	275 kg**
- 4, 5-section	2100 mm	Max. static load capacity (over base)	320 kg
- 6-section	2200 mm	Max. weight capacity	450 kg ***
- orthopedic/orthopedic attachment	2000-3300 mm	Power supply	24 V
Table top width	500 mm	Batteries (sealed, maintenance-free)	12 V, 7 Ah, 2 pieces
Total table top width	560 mm	Battery charging time	< 12 h
Height adjustment with mattress (tables with longitudinal shift)	715-1165 mm	Working time between battery charging	about 60 operations
Height adjustment with supermobile base (with big castors)	710-1160 mm	Work character	interrupted operation 2/18 min
Back rest adjustment	+75° ÷ -35°	Battery charger	built-in
Foot rest adjustment	+20° ÷ -90°	Charger power	230 V ~50/60 Hz
Foot rest abduction	max 180°	Power consumption from mains (max.)	1,5 A/230 V
Lateral tilts adjustment	±30°	Lifetime	10 years
Head rest adjustment	±45°	International Protection Marking	IP-X4
Elevation of the kidney bench (option)	~120 mm	IEC protection class	I
Longitudinal shift	300 mm	Application part type	B
Trendelenburg / reverse-Trendelenburg	±40°		
Table mass	250 kg		

* depend on connected segments of table top

** permissible load in reversed orientation of the table top: 140 kg

*** ALVO Serenada-B option

OPERATING TABLES

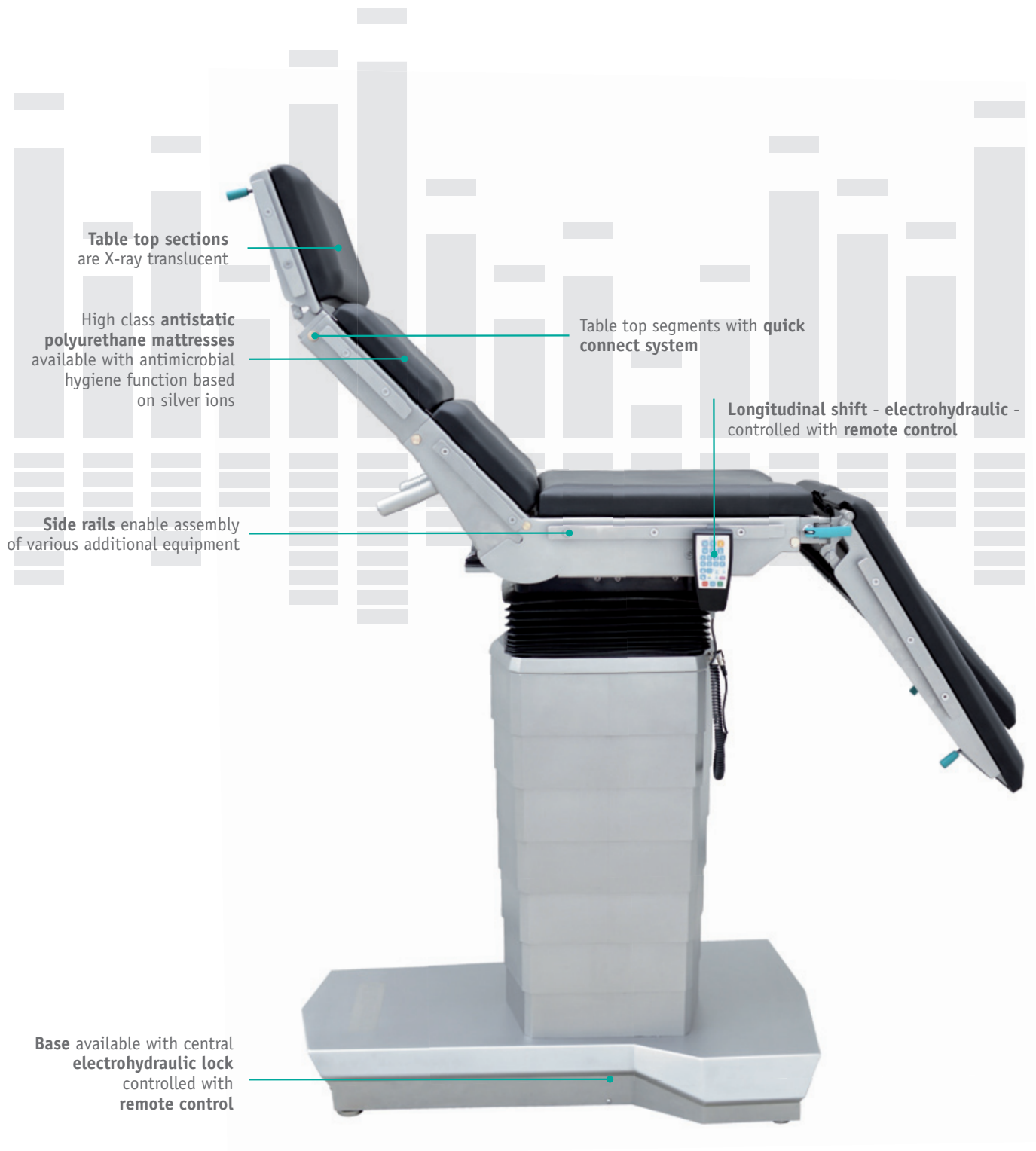

Table top sections are X-ray translucent

High class **antistatic polyurethane mattresses** available with antimicrobial hygiene function based on silver ions

Table top segments with **quick connect system**

Longitudinal shift - **electrohydraulic** - controlled with **remote control**

Side rails enable assembly of various additional equipment

Base available with central **electrohydraulic lock** controlled with **remote control**

ALVO RAPSODIA 4-05

ALVO RAPSODIA 4-05 has been designed to support the patient during all surgical procedures and interventions: general surgery, vascular surgery, endoscopy, neurosurgery, gynecology, urology and orthopedic procedures.

ALVO Rapsodia 4-05 is equipped with modular table top with quick connection system designed to increase the comfort of segments exchanges. Mobile base is equipped with electro-hydraulic brakes. Longitudinal shift of the table top is driven from remote controller and offers exceptional value of smooth movement.

One of the most advanced columns on the market (with vertical stroke of 630mm) helps to achieve exceptional values on highest and lowest positions. Combination of advanced electro-hydraulic drives with electronic systems helps to prevent collisions. Accelerating ramps at the start and stop of each movement makes work with Alvo Rapsodia 4-05 even smoother.

With ALVO Rapsodia 4-05 we proved, that not only working parameters matters. Exceptional value of this table is not only about numbers, it is also deeply rooted with our demand to create beautiful forms that are comfortable to use and looks beautiful.

ALVO Rapsodia 4-05 could be also connected with ALVO Integra system via Bluetooth.



Technical parameters ALVO Rapsodia 4-05			
Total length of the table top (modular)	2100-2250 mm*	Max. dynamic load capacity	275 kg**
Table top width	500 mm	Max. static safety working load	320 kg
Total table top width (with side rails)	560 mm	Power supply	24 V
Height adjustment (electrohydraulic) without mattress	610-1240 mm	Batteries (sealed, maintenance-free)	12 V, 7 Ah, 2 pcs
Stroke	630 mm	Battery charging time	< 12 h
Back rest adjustment (electrohydraulic)	+80° ÷ -30°	Working time between battery charging	about 60 operations
Foot rest adjustment (manual - gas spring supported)	+20° ÷ -90°	Work character	interrupted operation 2/18 min
Foot rest abduction (manual)	max. 180°	Battery charger	built-in
Lateral tilts (electrohydraulic)	±30°	Charger power	230 V ~50/60 Hz
Head rest adjustment (manual - gas spring supported)	±45°	Power consumption from mains (max.)	2 A / 230 V
Trendelenburg / reverse-Trendelenburg (electrohydraulic)	±40°	Lifetime	10 years
Longitudinal shift (electrohydraulic)	420 mm	International Protection Marking	IP-X4
Table mass	300 kg	IEC protection class	I
		Application part type	B

* depend on connected segments of table top

** permissible load in reversed orientation of the table top: 160 kg

TREATMENT TABLES

Table top sections
are X-ray translucent

High class **antistatic polyurethane mattresses**
available with antimicrobial
hygiene function based
on silver ions

Side rails enable assembly
of various additional equipment

Multi-sectional table top makes
it possible to exchange the sections
or longitudinal shift

Pantograph base
with central lock

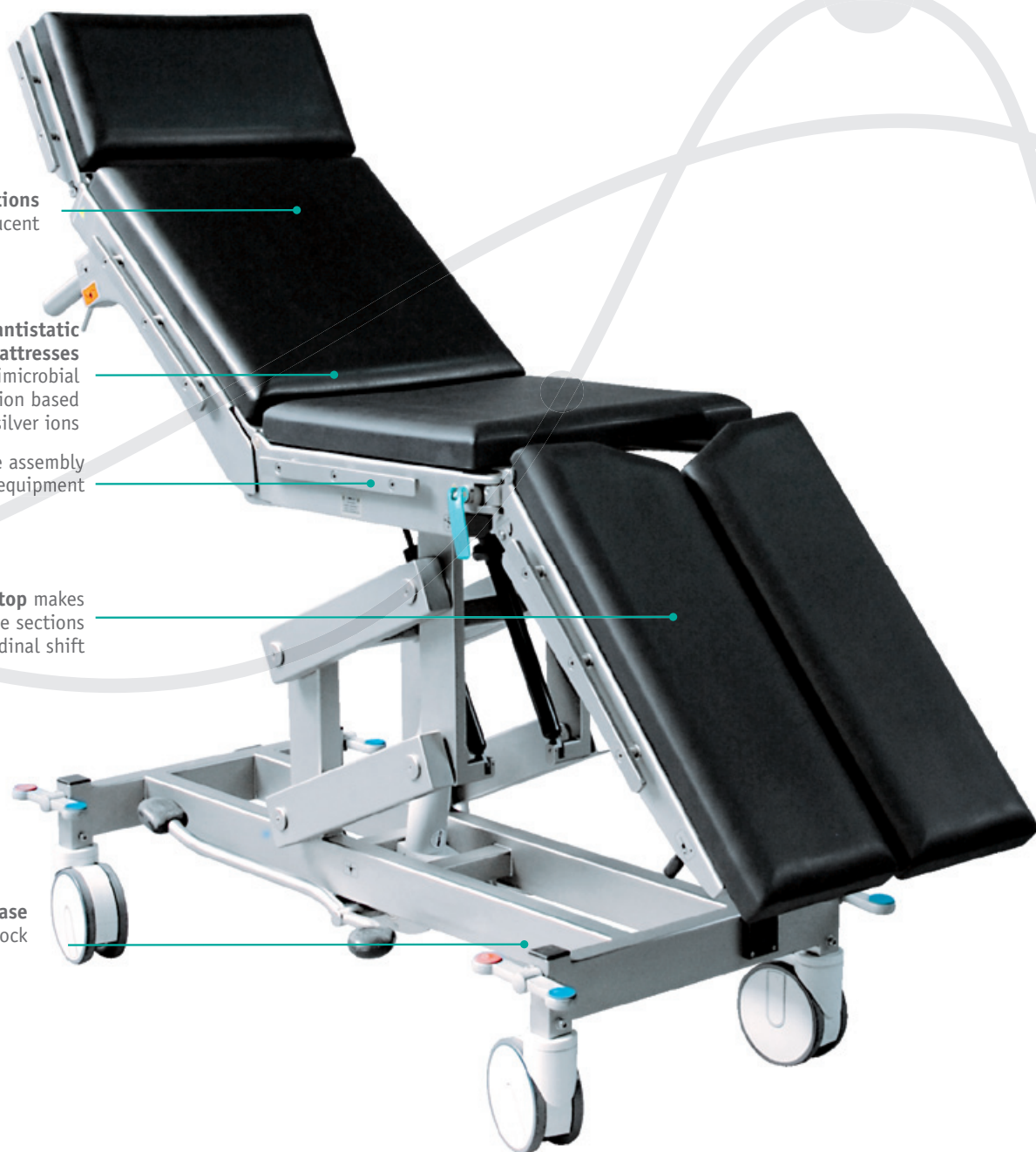

ALVO MENUET 4-00

Treatment table ALVO MENUET 4-00 has been designed to support the patient during all surgical procedures and operations: general surgery, vascular surgery, endoscopy, neurosurgery, gynecology and urology.

The mechanical operating table made of stainless, acid-proof steel, with sectional table top and mobile base equipped with mechanical central brake.

Vertical adjustment is provided with hydraulic system driven by foot pump. Body elevator adjustment is performed by crank mechanism. Other functional movements - longitudinal tilts and table top sections adjustments are gas spring supported.



Technical parameters - ALVO MENUET 4-00

Total length of the table with table top: - 4, 5-section - 6-section	2100 mm 2200 mm	Foot rest abduction	max 180°
Table top width	500 mm	Head rest adjustment	±45°
Total table top width	560 mm	Elevation of the kidney bench (option)	~120 mm
Height adjustment (with mattress)	800-1100 mm	Trendelenburg	20°
Back rest adjustment	+85° ÷ -45°	Reverse-Trendelenburg	45°
Foot rest adjustment	+20° ÷ -90°	Table mass	120 kg
		Max. dynamic load capacity	200 kg
		Lifetime	10 years

OPERATING TABLES SYSTEM



Side rails enable assembly of various additional equipment

Table top sections are X-ray translucent

Base available in three versions: **flat, rotary and mobile with mechanical central lock**

High class **antistatic polyurethane mattresses** available with antimicrobial hygiene function based on silver ions

ALVO SONATA 4-03

Operating table system ALVO SONATA 4-03 has been designed to support the patient during all surgical procedures and operations: general surgeries, vascular surgeries, endoscopy, neurosurgery, gynecology, urology and orthopedic procedures. Functional movements of the table column are provided by reliable electro-hydraulic system. Functional movements of the tabletop and longitudinal shift are supported by gas springs or mechanically. The electro-hydraulic operating table is made of stainless, acid proof steel.

ALVO Sonata is working in exchangeable table top system. It is designed for exchanging the table tops with use of specialized trolley for transportation. Wide range of available trolleys help to ensure comfortable work with the system.

ALVO Sonata 4-03 table system thanks to well-balanced combination between electronic systems and hydraulic and mechanical movements guarantees safety operation and increase the flexibility of the OR. Wherever reliable and uncomplicated table system is needed, ALVO Sonata 4-03 system is an answer.



Technical parameters ALVO SONATA 4-03

Total length of the table with table top: - 4, 5-section - 6-section - orthopedic/orthopedic attachment	2100 mm 2200 mm 2000-3300 mm	Trendelenburg / reverse-Trendelenburg	±40°
Table top width	500 mm	Table mass	250 kg
Total table top width	560 mm	Max. dynamic load capacity	225 kg*
Height with mattress (tables with longitudinal shift)	800-1130 mm	Power supply	24 V
Height with flat base	775-1105 mm	Batteries (sealed, maintenance-free)	12 V, 7 Ah, 2 pieces
Height with rotary base	785-1115 mm	Battery charging time	< 12 h
Back rest adjustment	+85° ÷ -45°	Working time between battery charging	about 60 operations
Foot rest adjustment	+20° ÷ -90°	Work character	interrupted operation 2/18 min
Foot rest abduction	max 180°	Battery charger	built-in
Lateral tilts adjustment	±30°	Charger power	230 V ~50/60 Hz
Head rest adjustment	±45°	Power consumption from mains (max.)	1,5 A/230 V
Elevation of the kidney bench (option)	~120 mm	Lifetime	10 years
Longitudinal shift	300 mm	International Protection Marking	IP-X4
		IEC protection class	I
		Application part type	B

* permissible load in reversed orientation of the table top: 135 kg

SPECIAL OPERATING TABLES

Reaching out for better outcomes
in intra-operative imaging



ALVO SERENADA-C

The specialized operating table **ALVO SERENADA-C** perfectly meets requirements needed for X-ray involved procedures. The floating table top performs smooth, fluent x-y movements to provide precise and safe patient positioning. The carbon fiber table top with 360° radiotranslucency ensures optimal imaging outcomes.

ALVO SERENADA-C can be controlled via ALVO INTEGRA system build in the wall e.g. behind glass panels or hung on a ceiling pendant near the operating field. ALVO INTEGRA provides variety of management options for the OR, integrating vendor independent technologies in one system. Your cathlab operating table ALVO SERENADA-C and your imaging source can now be managed from one spot!

* On request: table with load capacity 240 kg and table with fixed carbon fiber table top (imaging area 1700x560 mm)



Technical parameters ALVO Serenada-C

Total length of the table with table top: - carbon top	2350 mm	Max. dynamic load capacity	180 kg
Table top width	560 mm	Max. static load capacity (over base)	180 kg (~200 kg)*
Total table top width	560 mm	Power supply	24 V
Height with mattress (tables with longitudinal shift)	785-1235 mm* (without mattress)	Batteries (sealed, maintenance-free)	12 V, 7 Ah, 2 pieces
Height with mattress (tables without longitudinal shift)	665-1115 mm* (without mattress)	Battery charging time	< 12 h
Height adjustment with flat base	755-1205 mm* (without mattress and longitudinal shift)	Working time between battery charging	about 60 operations
Lateral tilts adjustment	±25°	Work character	interrupted operation 2/18 min
Longitudinal shift	400 mm	Battery charger	built-in
Lateral shift	240 mm	Charger power	230 V ~50/60 Hz
Trendelenburg / reverse-Trendelenburg	±30°	Power consumption from mains (max.)	1,5 A/230 V
Table mass	300 kg	Lifetime	10 years
		International Protection Marking	IP-X4
		IEC protection class	I
		Application part type	B

* also available

TABLE TOPS

Standard mattresses are made of polyurethane foam, 50 mm thick. **Memory foam mattresses** are also available - 60 or 80 mm thick. The last mentioned are made in ultrasound welding technology.



4-section table top

Table top construction is made of stainless, acid proof steel, entirely X-ray translucent. Table top sections are equipped with high class antistatic polyurethane mattresses covered with antibacterial cover. Head rest and leg rest sections are exchangeable.



5-section table top

Table top construction is made of stainless, acid proof steel, entirely X-ray translucent. Back rest section is equipped with body elevator. Table top sections are equipped with high class antistatic polyurethane mattresses covered with antibacterial cover. Head rest and leg rest sections are exchangeable.



6-section table top

Table top construction is made of stainless, acid proof steel, entirely X-ray translucent. Back rest section is equipped with body elevator, elongated leg rest sections in additional mattresses. Tabletop sections are equipped with high class antistatic polyurethane mattresses covered with antibacterial cover. Head rest and leg rest sections are exchangeable.



Modular table top

Table top construction is made of stainless, acid-proof steel, entirely X-ray translucent. Back rest, leg rest and head rest sections are exchangeable. Tabletop sections are equipped with high class antistatic polyurethane mattresses covered with antibacterial cover.

SPECIALIZED TABLE TOPS



Orthopedic table top

Table top construction is made of stainless, acid proof steel. Table top equipped with integrated orthopedic attachment, which cannot be disassembled. There are side mattresses, which can be disassembled and specialized head rest. Table top sections are equipped with high class antistatic polyurethane mattresses covered with antibacterial cover.

Carbon fibre table top, lite

Carbon fibre table top offers large radioluscent areas (360°). As standard include 30 mm mattress.



Carbon fibre table top, floating with mattress

Floating movements of the table in the range of 400 and 240 mm enable precise imaging control of the patient in any position. As standard include 30 mm mattress.



TABLE BASES



Mobile base

Ergonomic mobile base in T-shape with good mobility due to three castors. Base is equipped with central lock activated with foot lever, which guarantees reliable locking of the table on four built-in feet. Built-in feet are height adjustable. Antistatic castors ensure reliable disposal of static charge from the table. Optionally, the base can be equipped with electro-hydraulic locking system.

Pair of 125 mm diameter wheels on axis, placed on each side of the base

Rotating wheel on the front of the base (360 degrees of rotation, 100 mm diameter)





Mobile base with big castors

Ergonomic mobile base on four big double castors, enables good positioning of operator's feet. Base is equipped with central lock activated with foot lever, with possibility of blocking the straight direction. Antistatic castors ensure reliable disposal of static charge from the table. Cut out in the base facilitates access to the patient during gynecological or urological treatments.

Independent 4 wheels with diameter of 125 mm each, with central brake and straight position locking



Rotary base

Ergonomic stationary base with possibility of 330 degree rotation, ensures comfort work of medical personnel. Shape of the base enables full, collisions free use of C-Arm with the table and facilitates access to patient for medical personnel during operation. Mechanical system of locking the rotation is activated with foot lever or optional electro-hydraulic.

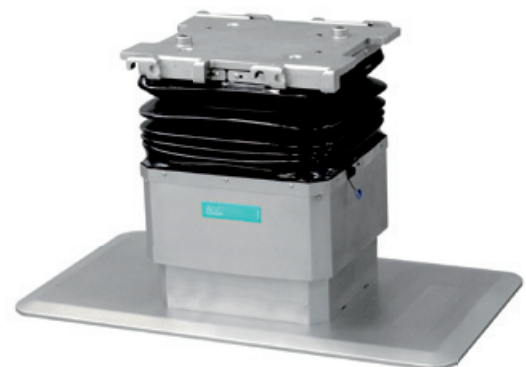

Flat base

Ergonomic stationary flat base, ensures comfort work of medical personnel. Shape of the base enables full, collisions free use of C-Arm with the table. The table is moved using the transport trolley.

EXAMPLES OF PATIENT POSITIONS



GENERAL SURGERY



POSITIONING WITH KIDNEY ELEVATOR



ENDOSCOPY



TRENDELENBURG



REVERSE TRENDELENBURG



STRUMA | ENT SURGERY



SIDE POSITIONING



UROLOGY | GINAECOLOGY



RECTAL SURGERY



LATERAL POSITIONING



HAND SURGERY



ARM EXTENSION



NEUROSURGERY | OPHTHALMOLOGY



PRONE POSITION



THORAX | KIDNEY SURGERY

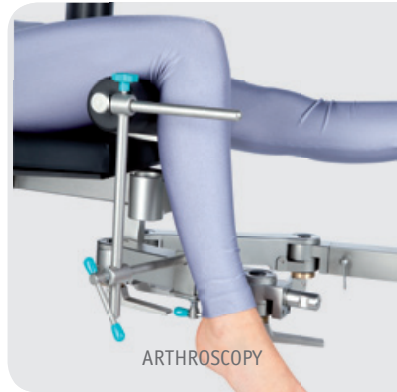

ARTHROSCOPY



SPINAL SURGERY



NEUROSURGERY, ENT
OPHTHALMIC HEADREST



TABLETOP EXTENSION FOR OPTIMAL
IMAGING AREA



ORTHOPAEDIC SHOULDER SURGERY



LOWER LIMB SURGERY | EXTENSION OF LOWER LEG

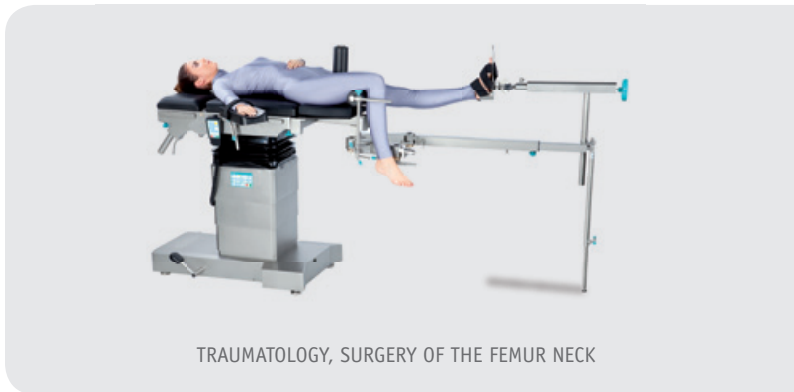

TRAUMATOLOGY, SURGERY OF THE FEMUR NECK

OPERATING TABLE ACCESSORIES



4-09-000 | Mobile holder for additional equipment



4-09-001 | Mobile holder for orthopedic attachment

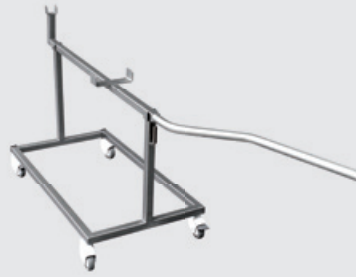

4-09-002 | Trolley for installing orthopedic attachment

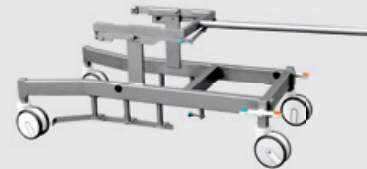

4-09-004 | Transport trolley for table tops and table ALVO Sonata 4-03



4-09-005 | Transport trolley for table tops



4-09-006 | Transport trolley for table tops, with height adjustment



4-09-007 | Transport trolley for table tops, with height adjustment and tilts



4-09-010 | Knee support



4-09-011 | Angle hand support



4-09-011 v2 | Hinged arm support



4-09-012 | Arm support



4-09-013 | Hand holder



4-09-014 | Thigh holder



4-09-015 | Shank holder



4-09-016 | Side support



4-09-016 | Shoulder support



4-09-017 Attachment for meniscus operation



4-09-018 Side support



4-09-019 Pubic support



4-09-020 Leg strap



4-09-021 Thigh strap



4-09-022 Abdominal strap



4-09-023 Wrist strap



4-09-024 Hand strap for anesthetic frame

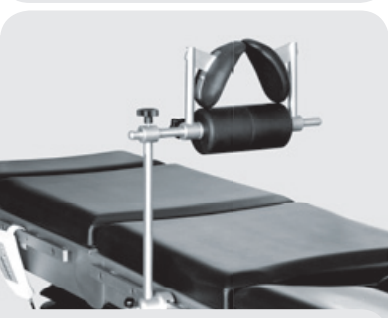

4-09-030 Attachment for knee operations



4-09-031 Gynecological bowl



4-09-032 Urological bowl



4-09-033 Proctological attachment



4-09-034 Thigh Attachment for hand operating



4-09-035 Holder for arm surgery



4-09-036 Hinged pubic support



4-09-037 Leg support

OPERATING TABLE ACCESSORIES

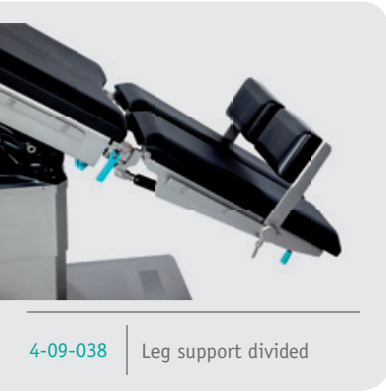

4-09-038 | Leg support divided

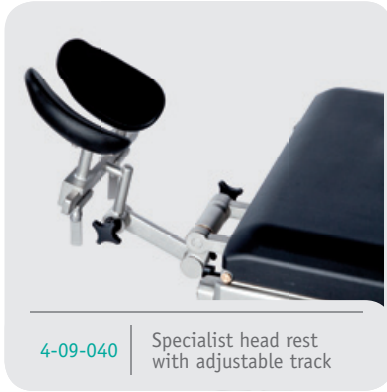

4-09-040 | Specialist head rest with adjustable track



4-09-042 | Specialist head rest with adapter



4-09-046 | Shoulder arthroscopy attachment

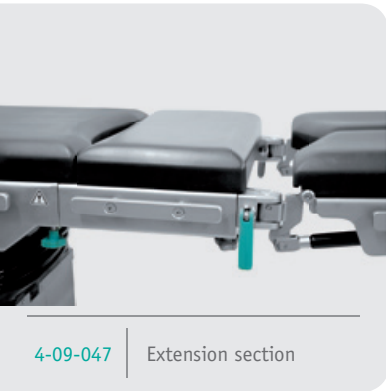

4-09-047 | Extension section



4-09-050 | Anesthetic frame



4-09-051 | Anesthetic frame with adjustable width



4-09-052 | Infusion holder



4-09-054 | Holder for tubes



4-09-055 | Tray for additional accessories



4-09-056 | Tray for additional accessories with angular support

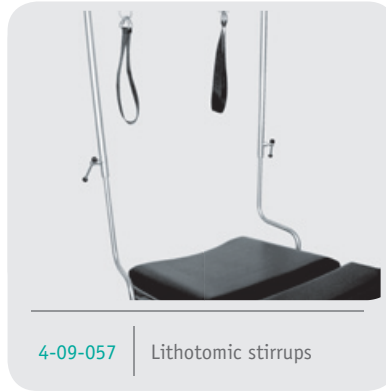

4-09-057 | Lithotomic stirrups



4-09-060 | Multiposition clamp



4-09-061 | One-position clamp



4-09-062 | X-ray tray



4-09-063 | Side rail



4-09-070 | Special mattresses

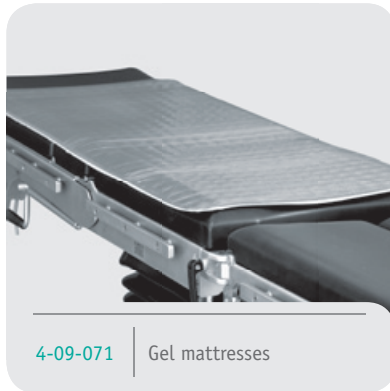

4-09-071 | Gel mattresses



4-09-072 | Heated mattresses



4-09-100 | Element of orthopedic attachment - with equipment

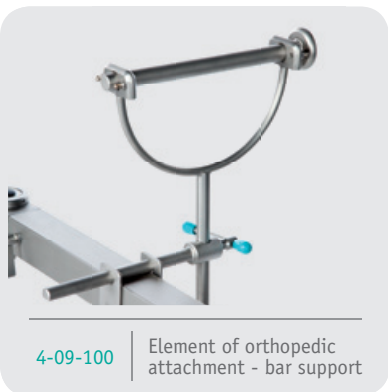

4-09-100 | Element of orthopedic attachment - bar support



4-09-100 | Element of orthopedic attachment - extension device



4-09-100 | Resistance roll for orthopedic attachment



4-09-110 | Knee operation attachment for orthopedic attachment



4-09-120 | Hip support for side position

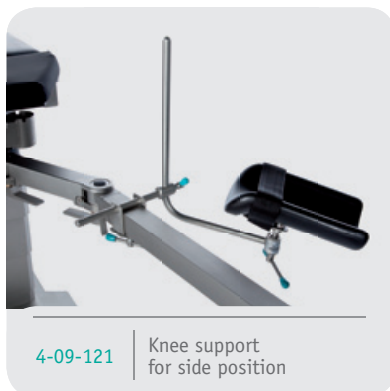

4-09-121 | Knee support for side position



4-09-122 | Support for orthopedic attachment arms

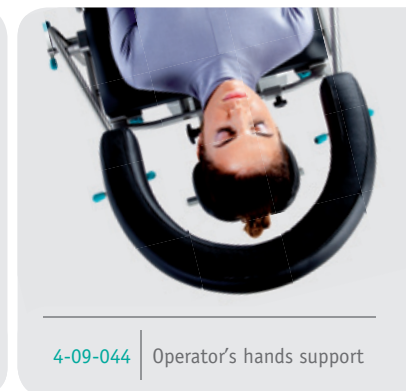

4-09-044 | Operator's hands support



4-09-043 | Specialist head rest



4-09-041 | Specialist head rest, wide

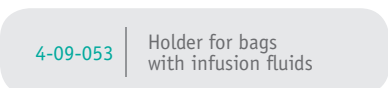

4-09-053 | Holder for bags with infusion fluids

Gel mattresses protect patients against decubitus. They are made of silicone gel covered with antistatic polyurethane foil.

Gel Mattresses

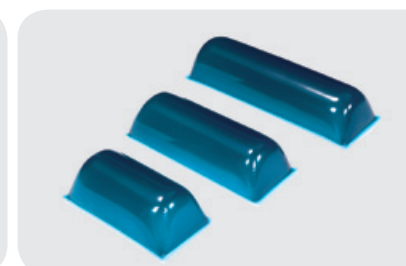
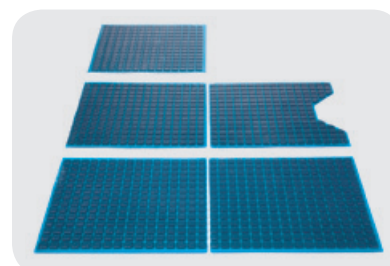

ALVO TRANSPA



ALVO Transpa is a mobile hospital trolley which enables to transfer the patient within the hospital. Its mobile structure allows to use it in any place, especially where it is not possible to install a fixed patient transfer unit.

According to different medical research sources, even up to 40% of health cases among medical professionals are spine and muscle complaints, being the result of manual patient handling.

In most hospitals a common, existing technique of transferring the patient to and from the operating table or a hospital bed is by pulling the patient across, in an inconvenient bent-over position. In such position, it is impossible for the nurse to use the strength of their legs to lift the majority of the patient's weight. The whole weight needs to be carried with the muscles of their lower spine parts. After many years, such daily routine does leave its mark on ones spine.

The ALVO Transpa system based on a regular hospital trolley, with rolling belt to smoothly roll the patients to and from an operating table or a hospital bed, is significant innovation in patient transfer.



Technical specifications ALVO Transpa

Total length of the trolley	2150 mm ±50 mm	Battery charging time	< 12 h
Total height of the trolley	1320 mm ±50 mm	Work character	interrupted operation 2/18 min
Table top width	650 mm ±50 mm	Working time between battery charging	about 60 patient transfers
Total table top width	1100 mm ±50 mm	Battery charger	Built-in
Height regulation	750-1000 mm ±20 mm	Charger power	230 V ~50/60 Hz
Transpa mass	~250 kg	Power consumption from mains (max.)	3,5 A / 230 V
Max. static load capacity	200 kg (250 kg)*	Lifetime	10 years
Power supply	24 V	International Protection Marking	IP-X4
Batteries (sealed, maintenance-free)	24 V, 15 Ah, 2 pcs	IEC protection class	I
		Application part type	B

* option

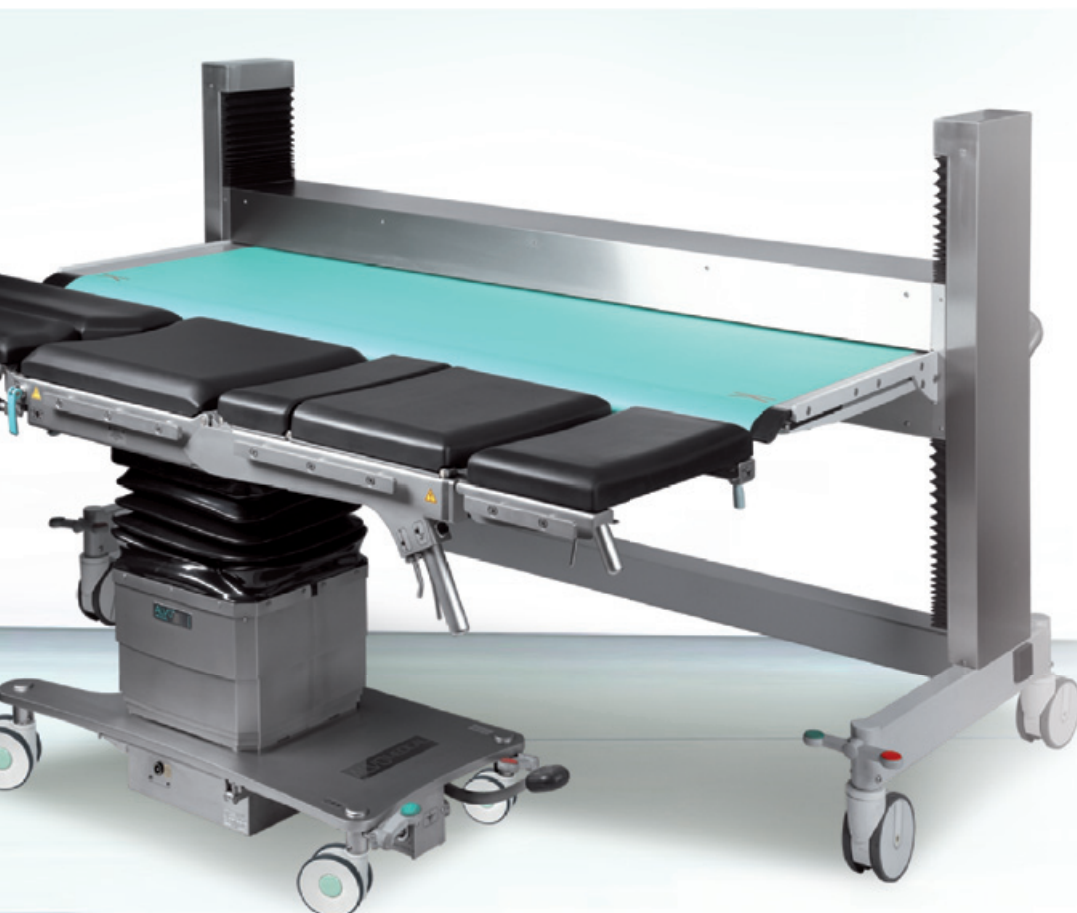

ALVO TRANSPA - BENEFITS



PATIENT:

- Safety and smooth transfer, no patient lifting needed

MEDICAL STAFF:

- Reduction of health cases among the medical staff
 - no need to lift the patient
- Transfer handled by no more than two operators
- Effortless maneuvering and control thanks to the driven wheel
- Stable construction thanks to a safety brake in each wheel
- Available for bariatric patients
- Optional safety barrier as additional equipment

HOSPITAL MANAGERS:

- Alternative to fixed solutions, which facilitates the hospital traffic planning
- Reduction of disinfection processes carried out in the hospital
- Long lifetime of the product
- A few alternative usage options

HYGIENIC:

- No devices crossing the border between clean and dirty area
- Less devices to be cleaned and disinfected
- Antimicrobial-protected surfaces
- Available with antimicrobial copper Cu+ fittings
- Easy floor cleaning thanks to the mobility of the system



USAGE OPTIONS FOR ALVO TRANSPA

The mobility and flexibility of the system allow a better planning of the traffic within the hospital. That makes ALVO Transpa the right solution for patient transfer both in new hospitals as well as in already existing facilities.

FIRST OPTION

If the hospital has a room, specifically designed to hold patient transfers, ALVO Transpa never crosses the border between clean and dirty areas inside the hospital. That reduces the risk of contamination in the OR, reducing at the same time the number of disinfection procedures needed.

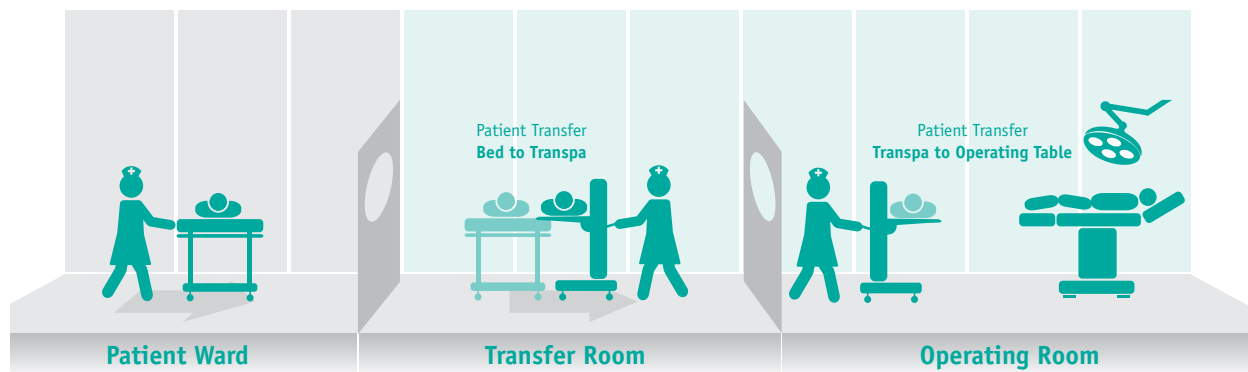

SECOND OPTION

The transfer is easily performed in the patient ward to improve both patient and staff safety and comfort.

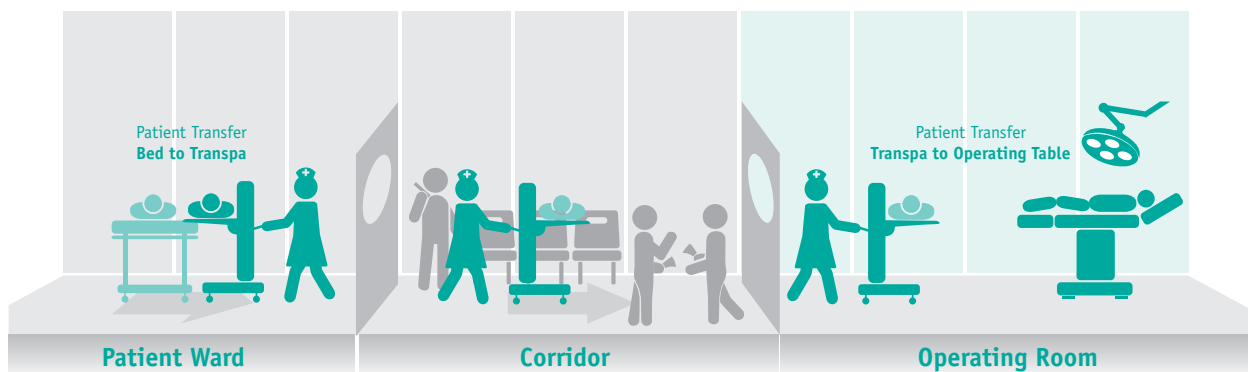

Self-retaining RETRACTOR SYSTEM



The self-retaining retractor system is intended to widen surgical wounds in order to provide good access to organs being operated on. It can be used in general surgery and specialist urological and bariatric procedures. It provides optimal access to the upper part of the abdominal cavity, and makes operation easy for a surgeon and safe for a patient. It is possible to fit the retractor with the blades for coverings and the plastic blades for the soft tissues.

The system is made of high quality materials - acid proof steel. Thus the retractor meets the highest safety and hygiene criteria of the operating room. The main retractor parts are: the vertical tripod and the band for mounting the fixation elements with blades. Mechanical systems are being used for the individual sections position adjustment.

Application:

- Suitable for major surgery related to medical conditions of lower oesophagus, diaphragm, stomach, duodenum, small intestine, large intestine, liver, bile ducts, pancreas, spleen and urinary system
- Treatments related to retroperitoneal space
- Treatments in trauma surgery via a transabdominal approach
- Gynaecological treatments where longitudinal incision is used

The retractor system is mounted to the side rails on the tabletop of the operating table. The system is made of high-quality stainless steel and meets the highest safety and hygiene standards of an operating room.



The Retractor System includes:

- 4-09-200-301 - Vertical tripod (460 x 60 ±10 mm), 1 piece
- 4-09-200-302 - Tripod with band fixation element (340 x 190 x 130 ±10 mm), 1 piece
- 4-09-200-303 - Tripod fixation element (130 x 90 ±5 mm), 1 piece
- Ring - 2 pcs.:
 - 4-09-200-304 - Stationary band (380 x 300 ±10 mm)
 - 4-09-200-305 - Foldable band (540 x 330 mm ±10 mm)
- 4-09-200-306 - Tray fixation element (40 x 40 x 30 ±5 mm), 5 pcs.





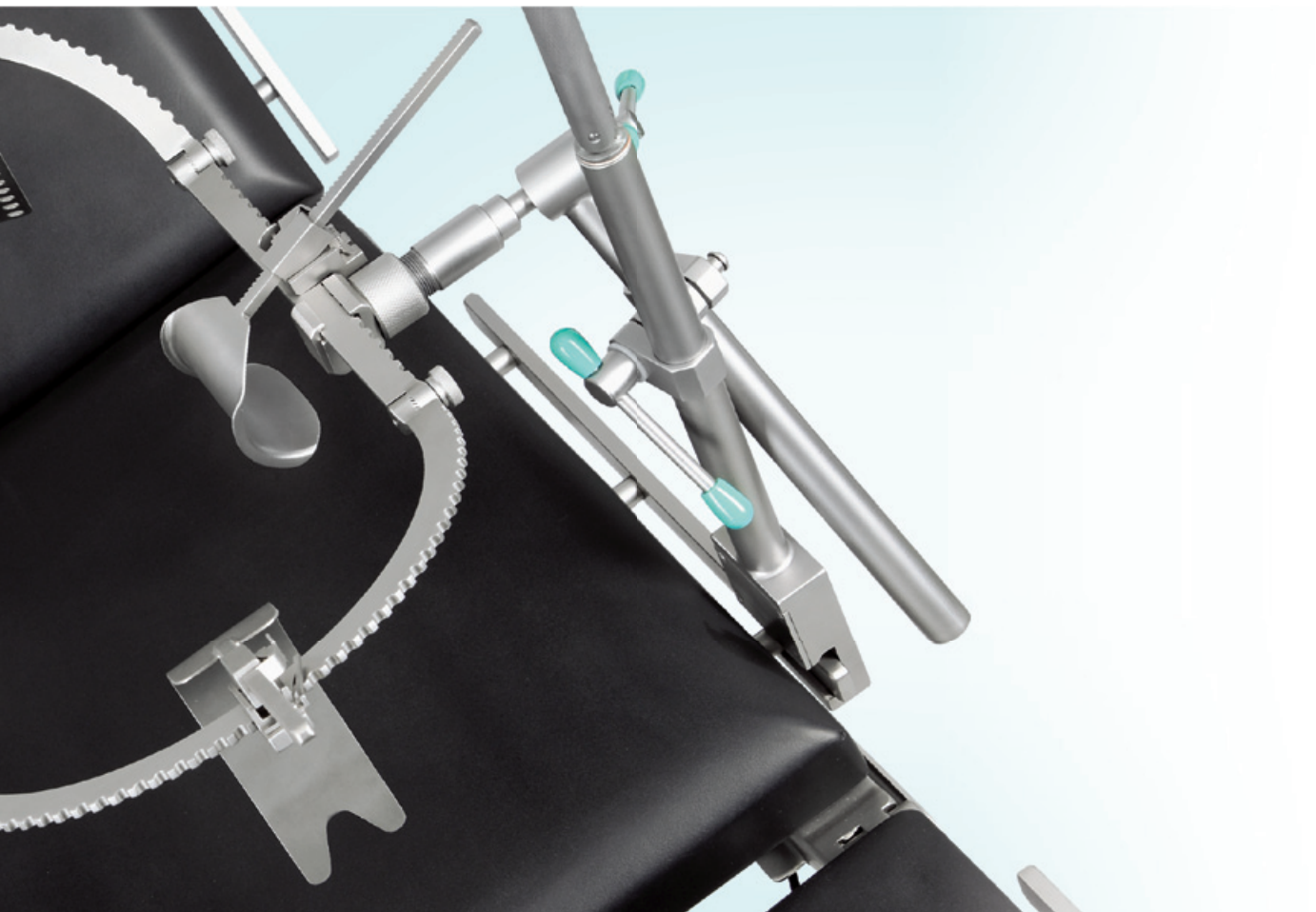



























Optional Fittings - blades:

- 4-09-200-310 - Deep blade
- 4-09-200-311 - Plastic blade, bowel, perforated
- 4-09-200-312 - Bowel blade, perforated
- 4-09-200-313 - Plastic blade for soft tissues
- 4-09-200-314 - Plastic blade for breastbone raise
- 4-09-200-315 - Blade for coverings
- 4-09-200-316 - Blade for coverings, for obese people
- 4-09-200-317 - Liver blade, plastic
- 4-09-200-318 - Blade for prostate operations



OPERATING TABLES

technical parameters

Technical parameters	ALVO PRELUDIUM 4-01	ALVO ETIUDA 4-02	ALVO SERENADA 4-04
Total length of the table with table top:			
– modular ****	–	–	2100-2250 mm
– 4, 5-section	2100 mm	2100 mm	2100 mm
– 6-section	2200 mm	2200 mm	2200 mm
– orthopedic/orthopedic attachment	2000-3300 mm	2000-3300 mm	2000-3300 mm
– carbon top	–	–	–
Table top width	500 mm	500 mm	500 mm
Total table top width	560 mm	560 mm	560 mm
Height adjustment with longitudinal shift (mobile base)	800-1050 mm*	750-1080 mm	715-1165 mm
Height adjustment without longitudinal shift (mobile base)	730-1030 mm	–	–
Height adjustment with longitudinal shift (mobile base with big castors)	730-980 mm****	750-1080 mm	710-1160 mm
Height adjustment with extended column range	–	665-1115 mm	–
Height adjustment with flat base	–	730-1060 mm	–
Height adjustment with rotary base	–	–	–
Back rest adjustment	+85° ÷ -45°	+85° ÷ -45°	+75° ÷ -35°
Foot rest adjustment	+20° ÷ -90°	+20° ÷ -90°	+20° ÷ -90°
Foot rest abduction	max 180°	max 180°	max 180°
Lateral tilts adjustment	±25° (±30°)*	±30°	±30°
Head rest adjustment	±45°	±45°	±45°
Elevation of the kidney bench (option)	~120 mm	~120 mm	~120 mm
Longitudinal shift (option)	300 mm*	300 mm	300 mm
Lateral shift	–	–	–
Trendelenburg / reverse-Trendelenburg	±30° (±35°)*	±40°	±40°
Table mass	230 kg	240 kg	250 kg
Max. dynamic load capacity****	200/250 kg	225/250 kg	275/450 kg
Max. static load capacity (over base)	–	275 kg	320 kg
Power supply	–	24 V	24 V
Batteries (sealed, maintenance-free)	–	12 V, 7 Ah, 2 pieces	12 V, 7 Ah, 2 pieces
Battery charging time	–	< 12 h	< 12 h
Working time between battery charging	–	about 60 operations	about 60 operations
Work character	–	interrupted operation 2/18 min	interrupted operation 2/18 min
Battery charger	–	built-in	built-in
Charger power	–	230 V ~50/60 Hz	230 V ~50/60 Hz
Power consumption from mains (max.)	–	1,5 A/230 V	1,5 A/230 V
Lifetime	10 years	10 years	10 years
International Protection Marking	–	IP-X4	IP-X4
IEC protection class	–	I	I
Application part type	–	B	B
Functions supported by: (movements control in standard tables)*	        	         	            
* We reserve the right to modify tables' construction due to technological improvements or special demands of our customers.			

ALVO RAPSDIA 4-05	ALVO MENUET 4-00	ALVO SONATA 4-03	ALVO SERENADA-C
2100-2250 mm	-	-	-
-	2100 mm	2100 mm	-
-	2200 mm	2200 mm	-
2000-3300 mm	-	2000-3300 mm	-
-	-	-	2350 mm
500 mm	500 mm	500 mm	560 mm
560 mm	560 mm	560 mm	560 mm
610-1240 mm	-	800-1130 mm	785-1235 mm* (without mattress)
-	800-1100 mm	-	665-1115 mm* (without mattress)
-	-	-	-
-	-	-	-
-	-	775-1105 mm	755-1205 mm* (without mattress and longitudinal shift)
-	-	785-1115 mm	-
+80° ÷ -30°	+85° ÷ -45°	+85° ÷ -45°	-
+20° ÷ -90°	+20° ÷ -90°	+20° ÷ -90°	-
max 180°	max 180°	max 180°	-
±30°	-	±30°	±25°
±45°	±45°	±45°	-
-	~120 mm	~120 mm	-
420 mm	-	300 mm	400 mm
-	-	-	240 mm
±40°	20° / 45°	±40°	±30°
300 kg	120 kg	250 kg	300 kg
275 kg	200 kg	225 kg	180 kg
320 kg	-	-	180 kg (~200 kg)*
24 V	-	24 V	24 V
12 V, 7 Ah, 2 pieces	-	12 V, 7 Ah, 2 pieces	12 V, 7 Ah, 2 pieces
< 12 h	-	< 12 h	< 12 h
about 60 operations	-	about 60 operations	about 60 operations
interrupted operation 2/18 min	-	interrupted operation 2/18 min	interrupted operation 2/18 min
built-in	-	built-in	built-in
230 V ~50/60 Hz	-	230 V ~50/60 Hz	230 V/~50/60 Hz
2 A/230 V	-	1,5 A/230 V	1,5 A/230V
10 years	10 years	10 years	10 years
IP-X4	-	IP-X4	IP-X4
I	-	I	I
B	-	B	B

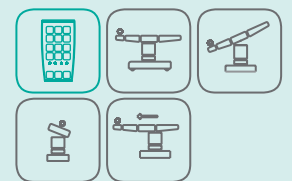
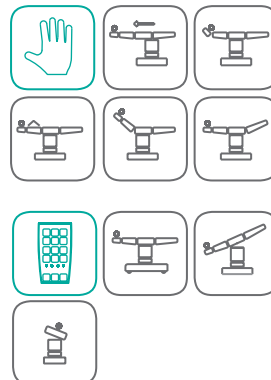
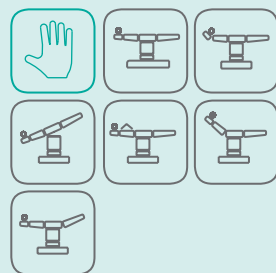



The continuous improvement of the medical situation is the goal we intend to achieve through increasing the comfort of both the doctor and the patient.



ALVO Sp. z o.o. Sp.k.
ul. Południowa 21a
64-030 Śmigiel, Poland
tel. +48 65 518 98 49
fax +48 65 518 98 56
www.alvo.pl



Management
System
ISO 13485:2003
ISO 9001:2008

www.tuv.com
ID 0000025088