

Introduction

This chapter introduces the CodeMaster XL+ (HP M1722A/B) and XL (HP M1723A/B) Defibrillator/Monitor and lists technical specifications.

Warning



Dangerous voltages capable of causing injury or death are present at the paddles or patient cables during normal operation. This defibrillator is to be used and serviced only by qualified personnel.

Caution



Operation of this device in the vicinity of high-powered transmitters or electrosurgical instruments may result in interference of the ECG display.

Note



Safe and effective use of medical instrumentation requires periodic inspection and preventive maintenance. Perform the preventive maintenance procedures in Chapter 4, Performance Verification and Maintenance, of this manual at the required intervals to ensure satisfactory instrument performance.

The CodeMaster XL+ and XL Defibrillator/Monitor

These instruments are portable defibrillator/monitors powered by internal battery or AC power. They combine a 360-joule defibrillator, ECG monitor, and annotating strip chart recorder in a compact, light-weight package. Instrument features include crisis-oriented controls, fast charge, a real-time clock, interchangeable paddles, and automatic documentation of events. The monitor includes a 5-inch screen which displays the ECG, selected ECG source, heart rate, and messages and alerts. A microprocessor-based system rejects noise and artifact, and automatically stabilizes and restores baseline.

In addition, the XL+ model has adjustable heart rate alarms, patient contact indicator (PCI), recorder event marker, complete recorder annotation, event summary, and 3- and 5-wire patient cable ECG capability. Transcutaneous external pacing is available as an option or field upgrade for the XL+; another option is a 12-pin ECG input connector that is compatible with the ECG patient cable. The XL+ can interface to the HP Central Station via an analog-only high-level ECG Out signal. Figure 1-1 shows the XL+ defibrillator.

Both models fit onto the MTRO-00336L cart. The cart features three drawers (with a latch/lock system) for storing suction pumps and other resuscitation equipment.

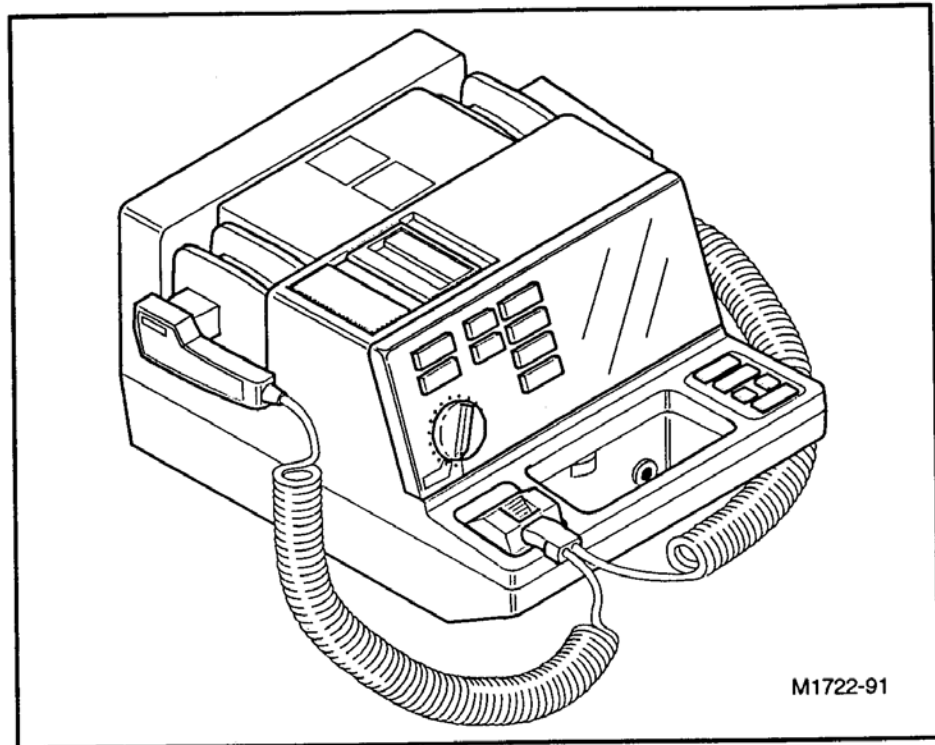

Figure 1-1. CodeMaster XL+ Defibrillator/Monitor

The defibrillators are designed for long-term reliability. The modular design makes extensive use of VLSI and gate-array technology. The modular approach means less downtime for the user, due to the quick field repair times inherent in the subassembly replacement philosophy of repair. The built-in menu-driven tests efficiently aid in identifying faulty operation, further speeding the repair process.

MTRO-00336L Cart

The MTRO-00336L Cart provides mobility for the CodeMaster defibrillators. The cart shell and drawers are constructed of a durable light-weight polymer material that will not corrode, rust, or dent. Built-in hand grips and 5-inch non-marring casters (two with brakes) provide easy maneuverability. The cart surfaces are smooth and stain-resistant, with rounded corners. Drawers can be removed without tools for thorough cleaning.

Inquiries

For questions or comments regarding these instruments, contact the nearest HP Sales/Service Office or to one of HP's Service Dispatch Centers. Always identify the instrument by model number and serial number in all correspondence. Hewlett-Packard sales and service offices are listed at the end of this manual. Toll-free numbers for Service Dispatch Centers are listed in Chapter 8, **Parts List**.

Specification Data

The following tables list the technical specifications for the defibrillators and the mobile cart. Specifications are the same for both models except where pointed out as being different.

Table 1-1. Physical Specifications

Parameter	Specification
Dimensions (l × w × h) defibrillator:	15.75" × 12.75" × 8.0" (40.05 cm × 32.39 cm × 20.32 cm)
cart:	22" × 34" × 34.5" (55.9 cm × 86.3 cm × 87.6 cm)
Weight defibrillator:	24 lbs. (10 kg) (includes external paddles, battery, and recorder paper.)
cart:	82 lbs. (37 kg)
Chemical resistance, cleaners:	Withstands the following: isopropyl alcohol (except leadwires and patient cable), mild soap and water, chlorine bleach and water (30 ml/l of water).

Caution

The main battery will be damaged if stored for extended periods at a temperature greater than 50° C.

Table 1-2. Environmental Specifications

Parameter	Specification
Temperature operating:	0° to 55° C (32° to 131° F) ¹
storage:	-20° to 70° C (-4° to 158° F) ¹
Humidity operating:	15 to 95% RH, non-condensing
storage:	15 to 95% RH, non-condensing
Pressure (altitude) operating:	To 15,000 ft. (4600 m)
storage:	To 15,000 ft. (4600 m)

¹Battery must be removed below 0° C (32° F) and above 45° C (113° F).

Table 1-3. Electrical Specifications

Parameter	Specification
Defibrillator	
Output energy (delivered):	2, 3, 5, 7, 10, 20, 30, 50, 70, 100, 150, 200, 300, and 360 joules.
Waveform:	Damped sinusoidal (Lown).
Charge control:	Push-button on apex paddle and on front panel.
Charge time (Batt. operation):	Less than 5 seconds to 360 joules.
Armed indicators:	Charge done tone, charge done lamp on apex paddle, and available energy indicated on display.
Paddle contact indicator (PCI): (XL+ only)	3-color LED bar graph array on STERNUM paddle indicates quality of defibrillator paddle contact before discharge.
Paddles:	Standard paddles are anterior/anterior, adult and pediatric. Adult electrodes (83 cm sq) slide off to expose pediatric electrodes (21 cm sq). Paddle cord is 10 ft (3m). Full range of internal paddles are available.
Synchronizer:	"SYNC" message appears on monitor and is annotated periodically on recorder while in synchronous mode. An audible beep sounds with each detected R- wave, while a marker on the monitor and sync designator on the recorder strip indicate the discharge point.

Table 1-3. Electrical Specifications (continued)

Parameter	Specification
Monitor	
Inputs:	ECG may be viewed through paddles or patient cable. Lead I, II, III, or PADDLES selectable. Additional leads (avR, avF, AvL, V Leads) and PADS are available (XL+ only). Monitor and recorder indicate selected ECG source.
Lead fault:	"LEADS OFF" message and dashed baseline appear on monitor if a lead becomes disconnected.
Common mode rejection:	Leads: ≥ 100 dB and Paddles: ≥ 90 dB measured as per AAMI standards for cardiac monitors (EC13).
Pace pulse rejection:	The pace pulse rejection algorithm of this product meets the requirements of Section 3.1.4.1 (Pacemaker Pulse Rejection With Over/Undershoot) of AAMI EC13 - 1983 (Cardiac Monitors, Heart Rate Meters and Alarms). This product will not reject pace pulses as described in Section 3.1.4.2 (Pacemaker Pulse Rejection With Over/Undershoot) of the same document.
Display size and type:	5 inch diagonal (12.7 cm) CRT for 4 seconds of ECG data on screen; non-fade, fixed trace. Scrolling trace is selectable.
Sweep speed:	25 mm/sec nominal.
Frequency response:	0.5 to 40 Hz.
Heart rate display:	Digital readout on monitor from 15 to 350 BPM.
Heart rate alarms:	Three pairs of high and low heart rate alarm limits from 20 to 280 BPM. On XL+, limits are configurable.
ECG output:	1 V/mV.
Patient cable length:	10 ft.
Thermal Array Recorder	
Event summary: (XL+ only)	Stores and prints 3 seconds of pre-critical event data, and 8 seconds of post-critical event data for up to 28 events. Data is retained after unit is turned off.
Annotates:	Time, date, HR, ECG mode, event marker, defibrillator mode, and selected energy. Additionally, on XL+, actual delivered energy, peak current, and patient impedance.
Speed:	25 mm/sec.
Paper size:	50 mm by 30 m (100 ft).
Recorder mode:	May be configured to automatically document events and ECG during defibrillation episodes. The recorder can be configured to run in either real time or with a 6 second delay.
Frequency response:	0.5 to 40 Hz. Additionally, on XL+, 0.05-150 Hz selectable.

Table 1-4. Power and Battery Specifications

Parameter	Specification
AC Line Power	
Line frequency:	50 and 60 Hz.
Line voltage:	100-230 V AC \pm 15%.
Battery	
Type:	Rechargeable sealed lead-acid. 4 Ah, 12 V nominal.
Charge time:	Approximately 2 hours to 90% of full capacity. 18 hours to 100% capacity. Repeated charging to less than 100% will reduce useful life of battery.
Capacity:	Approximately 2.5 hours of monitoring, or 50 full-energy discharges, or 1 hour of monitoring and recording.
Indicators:	Illuminated LED indicates battery is charging. "LOW BATTERY" message appears on monitor when limited battery capacity remains.

Table 1-5. External Pacer (Optional—XL+ only)

Parameter	Specification
Current pulse amplitude:	30 mA to 200 mA.
Pulse width:	20 msec.
Rate:	40 ppm to 180 ppm.
Modes:	Demand or fixed rate.
Refractory period:	40 to \leq 80 ppm 350 msec; >80 to 180 ppm 250 msec.

Operation

This chapter briefly summarizes the defibrillator's operation. This information is intended for the service person and is not a substitute for the information in the user manuals. Refer to one of these manuals for more comprehensive and detailed operating instructions.

- *CodeMaster XL+ User's Guide*
- *CodeMaster XL User's Guide*

Controls, Indicators, Display, and Connectors

All defibrillator controls and indicators are located on the main keypad, as shown in Figure 3-1. See Table 3-1 for a description of keypad functions. Other figures and tables provide information about the visible indicators on the keypad, and the audible indicators.

Keys for the optional pacer (XL+ only) are located on the right side of the carrying handle. These keys are shown in Figure 3-3. Figure 3-4 shows the areas of the display; the information it provides is described in Table 3-5.

The operation of some keys and indicators is affected by the configuration choices made in the setup menus. Such instances are identified by bold text and references to *setup*. For more information on configuration choices and modifying instrument setup, see Chapter 2, **Installation and Configuration**.

The Keypad

Figure 3-1 shows the defibrillator keypad. The controls and indicators available on the keypad are described on the following pages. The keys and controls that affect defibrillator functions are all located on the left side of the panel. The center column of keys are for recorder functions. And, the keys on the right let you control monitor functions.

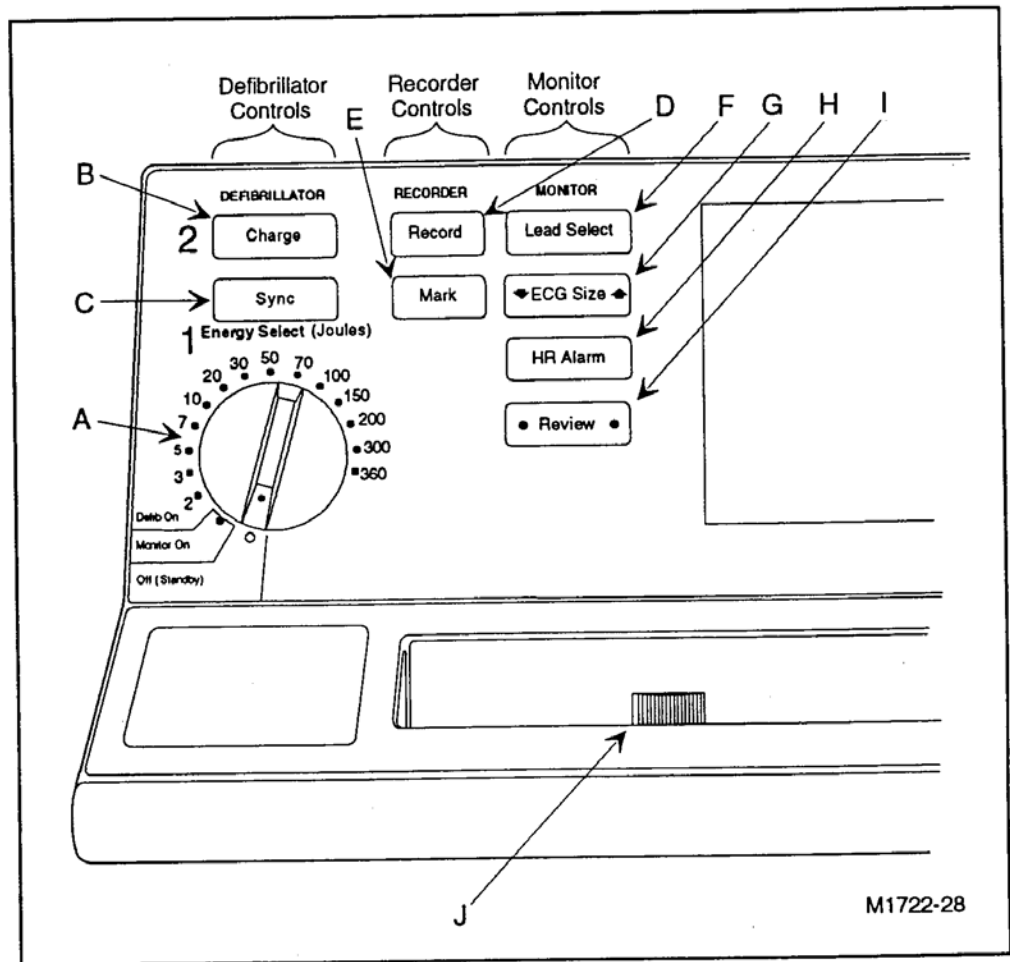

M1722-28

Figure 3-1. The Keypanel

Table 3-1. Defibrillator Keypanel Controls

A	Energy Select	In Defib On position, selects the energy charge level for defibrillation, in joules. Also, switches the defibrillator between the Monitor On state for monitoring, and the Off (Standby) state.
B	Charge	Charges the defibrillator to the energy level set by the Energy Select control. When charge level is reached, the Charge indicator lights, and the Charge Done tone sounds, if enabled (setup).
	Shock ⚡	Administers shock when buttons labelled ⚡ on paddles are pressed simultaneously. The Shock buttons for internal paddles or pads are located on the paddles connector.
C	Sync	Changes operating mode between immediate shock mode (Defibl) and synchronized with next R-wave shock (Sync). After shock, unit defaults to mode selected in MODE AFTER CV (setup).

Table 3-1. Defibrillator Keypanel Controls (continued)

D	Record	Starts and stops the recorder printing. Printing starts immediately. If delay mode is enabled (setup), the ECG data is delayed 6 seconds. Otherwise ECG data is printed real time.
E	Mark	When the recorder is on, pressing Mark annotates the ECG by printing the marker symbol (▼) at that point, if the recorder is printing. If the recorder is not on, pressing Mark also starts the recorder (if Record on Mark is enabled in setup).
F	Lead Select	On the display, changes the ECG source to be monitored. Each time you press Lead Select , a different ECG source is displayed as the current selection. The power-on lead selection can be changed in setup.
G	▼ ECG Size ▲	On the display, exits Autogain mode and increases or decreases the height of the displayed ECG.
H	HR Alarm	On the display, selects one of three sets of heart rate limits. Each time you press HR Alarm , a different set (a low limit and a high limit) is displayed as the current selection. The value of each set of limits can be changed in setup (XL+ only).
I	Review	Prints an Event Summary record.
J	QRS Beeper Volume	Changes the volume of the QRS beeper.

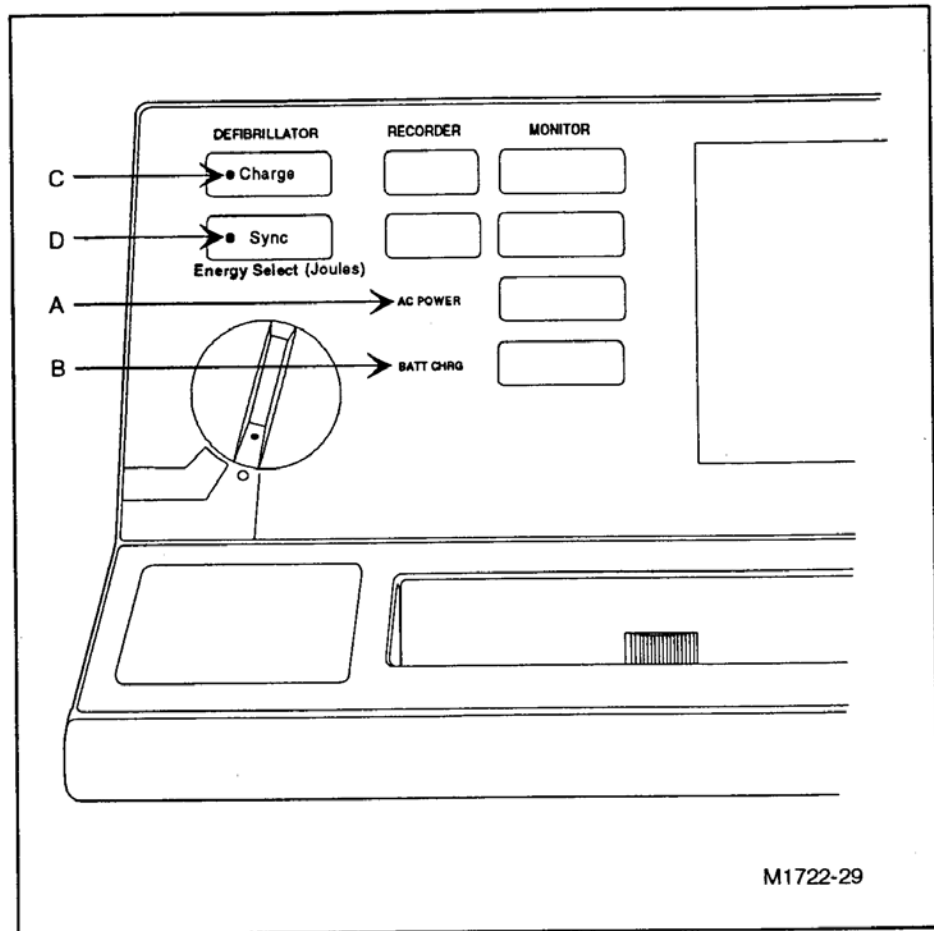

M1722-29

Figure 3-2. Defibrillator Visible Indicators

Table 3-2. Defibrillator Visible Indicators

A	AC POWER	Indicates that the unit is plugged into AC power.
B	BATT CHRG	Indicates that the unit is plugged into AC power and that the battery is being charged.
C	Charge Done	Indicates that the Defibrillator Energy Storage capacitor in the unit is armed and ready to shock. The indicators in the Charge panel key and on the Apex paddle light up.
D	Sync light	Indicates that the unit is in synchronized shock mode as opposed to defibrillator mode. Flashes off each time an R-wave is detected.
	Paddle contact indicator (PCI) on Sternum paddle	Indicates how well paddles contact patient. (XL+ or with optional paddle set for XL.)

Note



Defibrillator visible indicators cannot be enabled or disabled in setup.

Defibrillator Audible Indicators

The defibrillator emits various tone patterns to indicate different aspects of operation. Table 3-3 lists the tones and their functions.

Table 3-3. Defibrillator Audible Indicators

Power-on tone	When the Energy Select control is turned from Off (Standby) to Monitor On or one of the Defib On positions, the tone indicates that the power-on cycle is normal.
Charge Done tone	Sounds when instrument is charged and ready to deliver a shock. Can be disabled in setup.
Auto Disarm tone	Sounds an intermittent beep ten seconds prior to an internal disarm (this beep cannot be disabled).
QRS Beeper	Sounds when an R-wave is detected. Volume is controlled by front panel control. Cannot be disabled in setup.
CRT Alerts tone	Sounds three beeps when a message appears on the screen. Can be disabled in setup.
HR Alarms	Sounds when the heart rate is above the higher alarm limit or below the lower alarm limit. Three sets of limits are available. The available limits are selectable in setup (XL+ only). Alarm volume can be set in setup.
Shutdown Warning tone	Alternating pitch sounds during the 60 second period before the unit shuts down due to low battery power. Serves as an alert to plug the unit into AC power. Cannot be disabled in setup.
Pacer Stopped Alarm	If the pacer stops for any reason than a keypress (Pads off, Pads adaptor off, Leads off, or Pacer failure), an alarm tone will sound. Pressing any key will stop the alarm.
General Failure Alarm	Defib failure, System failure, Monitor failure. Pressing any key will stop the alarm.

The Pacer Keys

The pacer keys and functions are available only if the pacer option is installed (XL+ only). The keys are shown in Figure 3-3 and described in Table 3-4.

The only pacer functions that are affected by setup choices are the *power-on* values for the **▼ Rate ▲** and **▼ Output ▲** functions.

When you press **Pacer On**, the pacer functions turn on and PACER STOP appears at the bottom of the display, indicating that the pacer is on but no pulses are being output. Also displayed is the current mode (demand or fixed) and the current rate in pulses per minute (PPM) and output level (in mA). Pressing **Mode** toggles the pacer mode between fixed and demand pacing; **Mode** can be changed *only* when pacer output is off (see PACER STOP on the display). To start or stop pacer output, press **Start/Stop**. You can change the rate and output values at any time by pressing the **▼ Rate ▲** and **▼ Output ▲** keys.

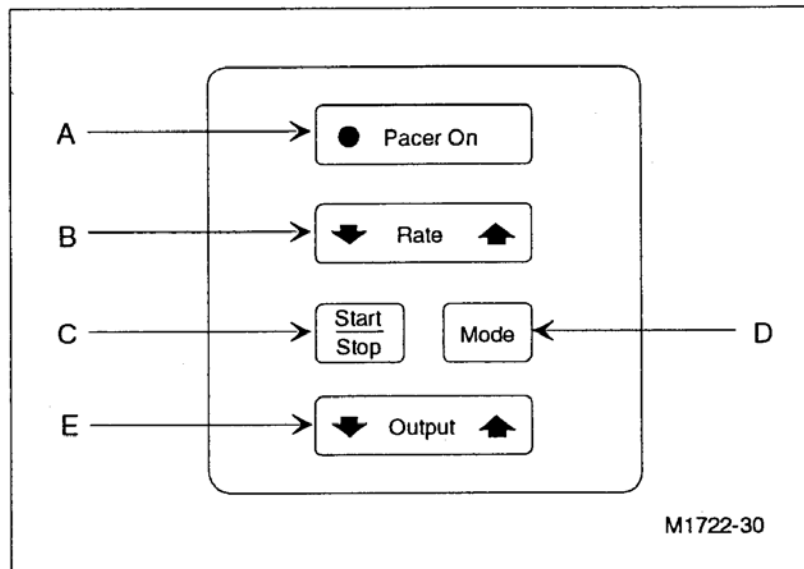

Figure 3-3. The Pacer Keys

Table 3-4. Pacer Controls (Option—XL+ only)

A	Pacer On	Turns the pacer functions on or off. Indicator lights when pacer is on.
B	▼ Rate ▲	Adjusts the pacer rate (pulses per minute) up or down. Increments and decrements in 10 ppm steps. The current rate is displayed as xxPPM.
C	Start/Stop	Starts and stops pacer pulse output at the rate set by Rate and the amplitude set by Output . On the display, PACING or PACER STOP is displayed.
D	Mode	Changes pacer mode between fixed and demand pacing. Mode can be changed only when pacer output is off (PACER STOP on the display). Press Start/Stop to turn pacer output off.
E	▼ Output ▲	Adjusts current level (mA) of pacing pulses up or down; the current level is shown on the display as xxmA. Increments in 10 mA steps from 30 mA to 100 mA, 20 mA steps from 100 mA to 200 mA, and decrements in 5 mA steps.

The Monitor Display

This section describes the information areas of the display, and explains the effects of setup choices. Figure 3-4 shows the information areas on the display; screen information is described in Table 3-5.

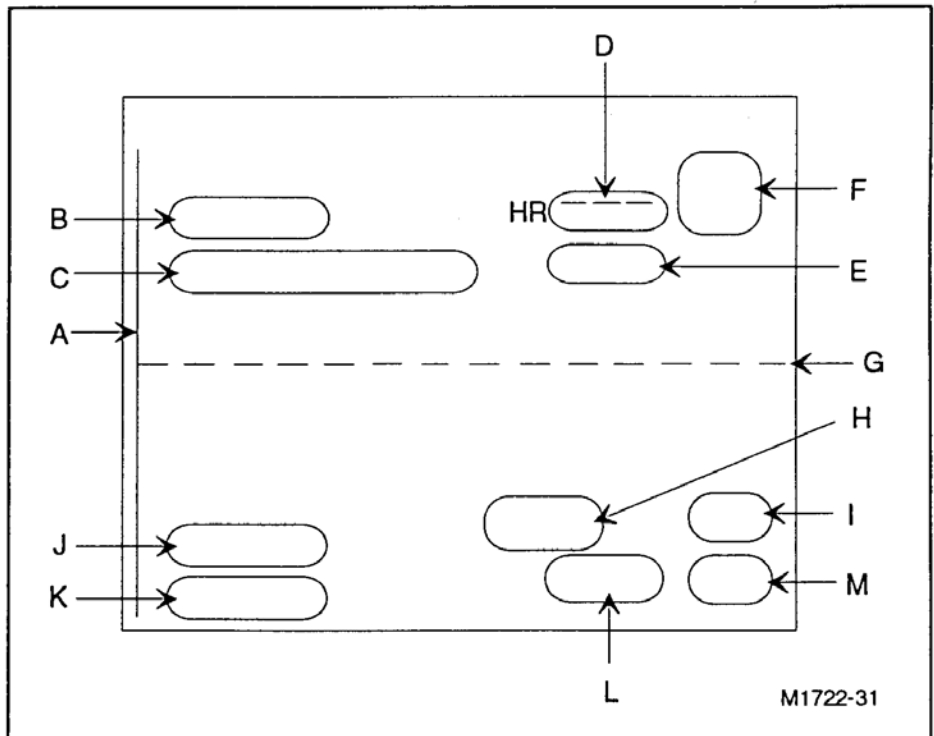



Figure 3-4. Display Information

Table 3-5. Information Areas of the Display

A	ECG Size	The bar along the left margin of the display indicates the size of a 1 mV signal. When you first turn on the instrument, it automatically adjusts the size. When you press ▼ ECG Size ▲ , Autogain turns off; the size stays at the setting you select by pressing ▼ ECG Size ▲ . When you turn the instrument to Off (Standby) and then back to Monitor On or one of the Defib On settings, Autogain is enabled again.
B	LEADS OFF or PADS OFF message	Shows a message that indicates you are attempting to use a function that requires leads or pads that are not connected, or are connected and making poor contact with the patient.
C	DEFIB DISARMED message	Indicates that the defibrillator has been disarmed. This message appears after an automatic disarm, after holding the Charge button for 60 seconds, after an open paddles discharge, or after a manual disarm (turning the Energy Select control to Monitor On when the unit was charged). To recharge the defibrillator, press Charge again.
D	HR xxx	Dashed lines indicate no heart rate is being measured. Numbers indicate the average heart rate detected by the monitor.
E	PADDLES, PADS, LEAD I, II, III, and optionally aVR, aVL, aVF, V	ECG source currently selected. If you pick a source that is not connected to the instrument, LEADS OFF, NO PADS, or NO PADDLES is displayed.
F	xxx/xxx, or bell symbol  	When you select a set of HR alarm limits, the limits shown on the display are replaced by a bell symbol. If the heart rate violates a limit, a tone sounds and the limits are displayed with highlighting over the limit that was exceeded. You can press HR Alarm to silence the tone; then, the bell has a diagonal bar through it to show that the limits are no longer being checked. Select the limits again to have the instrument check the heart rate against the limits.
G	Trace	A dashed line indicates that the instrument is not receiving a patient ECG. When an ECG is received, either a scroll- or sweep-type trace is displayed. The trace type is selectable in setup.
H	SYNC	SYNC is displayed when the instrument is in synchronized shock mode as opposed to defibrillator mode. Flashes off each time an R-wave is detected. Sync key changes the mode.
I	XXXJ	Shows the current charge energy level in joules. Level is selected by the Energy Select control.
J	PACER STOP or PACING	Displayed when pacer function is turned on. (Option, XL+ only.)
K	xxxx MODE	When pacer is on, shows current pacer mode: demand or fixed. (Option, XL+ only.)
L	xxPPM	When pacer is on, shows current ▼ Rate ▲ setting. (Option, XL+ only.)
M	xxmA	When pacer is on, shows current pulse level set by ▼ Output ▲ . (Option, XL+ only.)

Connectors

The defibrillator includes three connectors, in addition to the AC power plug connector. The three connections are the defibrillator connector, the ECG Input connector, and the ECG Output connector. Paddles/pads sets attach to the defibrillator connector; leads attach to the ECG Input connector. The high-level analog signal at the ECG Output connector can be connected to an external monitor using a 1000:1 voltage divider cable. Compatible external monitoring divider cables are listed in Table 3-6.

Table 3-6. External Monitoring Cables

1000:1 voltage Divider Cable Connector Type	HP Part No.
Six Pin	M1782A
Eight Pin	M14482A
Twelve Pin	M1783A

Six-pin divider cable: p/n M1782A, eight-pin divider cable: p/n M1783A, twelve-pin divider cable: p/n 14482A. The ECG output is also compatible with the interface to the 14482A/B HP Central Station analog input.

Note



The ECG Output connector should not be used to synchronize another defibrillator (the ECG In-to-ECG Out delay is 35 milliseconds).

All three connectors are located on the front part of the defibrillator. For information on using these connectors, see Chapter 2, **Installation and Configuration**.

Safety Considerations



The following safety considerations are designed to protect the user and patient during operation of the defibrillator and pacer. Other safety information is located in appropriate parts of this manual.

The defibrillator stores high voltage energy and is capable of delivering up to 360 joules of power to a 50 ohm impedance.

- Turning the Energy Select control to the **Off (Standby)** position does not remove power from the instrument. Disconnecting the unit from an AC outlet does not remove power because the battery powers the instrument when AC power is unavailable.
- There are three methods to disarm a **charged (armed)** instrument:
 - Turn the Energy Select control from the energy level setting to the **Monitor On** or **Off (Standby)** position.
 - Place the paddles in their holders on the defibrillator, and depress both Shock buttons.
 - The instrument automatically disarms when it has been left charged for 60 seconds.

Caution



- Do not leave the instrument turned on when it is not in use and it is not plugged into AC power.
 - Do not discharge the defibrillator with the paddles shorted together. To do so can cause burning and pitting of the metal paddle contacts.
 - Disconnect any other medical electronic equipment from the patient during defibrillation discharge unless labelled as defibrillator-protected () (.
-

Warning



-
- Avoid open paddle discharges. Dangerous high voltages exist on the paddles when the defibrillator is discharged. Contact with this high voltage could cause death or serious injury.
 - Avoid touching any metal surfaces on the instrument during shock.
 - Avoid connecting the patient to several devices at once, because leakage current limits can be exceeded.
 - Never touch the bed, the patient, or any equipment connected to the patient during defibrillation.
 - Keep the defibrillator and the immediate area clean and dry at all times to avoid creating potentially dangerous electrical paths.
 - Do not open the instrument case. Dangerous high voltages will be exposed. Only qualified service personnel can service the instrument.
 - Do not use the defibrillator in a flammable or oxygen-rich atmosphere. This will cause an explosion hazard.
 - Do not rely entirely on heart rate alarms. Rate meters on pacemaker patients can continue to count the pacemaker rates during cardiac arrest or some arrhythmias. Keep pacemaker patients under close observation.
-

AC and DC (Battery) Operation

The defibrillator operates on AC line power, on internal battery power, or on both. The follow list provides instructions for AC operation.

- When the **BATT CHRG** indicator is on, the battery is recharging.
- The battery recharges while the instrument is connected to AC power, even if the Energy Select control is in the **Off (Standby)** position.
- A fully depleted battery recharges to 90% of full capacity in two hours, and to 100% capacity in 18 hours. To preserve battery integrity, the battery must be fully recharged each time the battery is depleted.
- A new battery, or one that has been stored for an extended period, requires 24 hours of charging before use.
- While the defibrillator is not in use, connect it to AC power, with the Energy Select control in the **Off (Standby)** position. This maintains a full battery charge and prolongs battery life.
- To operate on internal battery power only, disconnect the power cord from the AC outlet.

- A fully charged battery nominally provides fifty 360 joule charge-shock cycles, or approximately 2.5 hours of continuous monitoring (15°C to 40°C).

Note



Continuous recording reduces the available monitoring time when you are using the unit on battery power.

Caution



When the LOW BATTERY message is displayed on the monitor, plug the unit into AC power. When the LOW BATTERY message is first displayed, there is typically enough reserve battery capacity to provide either 30 minutes of monitoring or five 360 joule charge-shock cycles before the battery fully discharges and the instrument shuts down. When the battery charge is almost depleted, a continuous audible alarm begins sounding. The alarm continues for 60 seconds; then, the instrument automatically shuts down. Plugging the unit into AC power stops the warning and the shutdown; full operation is immediately restored.

Frequent battery discharges to the low battery level degrades battery life.

Warning



Properly dispose of or recycle depleted batteries according to local regulations. Do not disassemble, puncture, or incinerate the disposed batteries.

Operating Modes

The instrument operates as a defibrillator, monitor, or pacer (option), and it has a setup/diagnostic mode.

Each operating mode is described in the following text. For information on the setup/diagnostic mode and using the setup menus to configure the instrument, see Chapter 2, **Installation and Configuration**.

Defibrillator Operation

Warning



Dangerous voltages capable of causing injury or death are present at the paddles or patient cables.

There are three basic steps to operating the defibrillator:

1. **Select Energy**
 - a. Turn the Energy Select control to the desired energy level; the defibrillator is now on.
 - b. Prepare and apply paddles; position paddles on patient and apply correct pressure. See user's guide for detailed information.
2. **Charge**
 - a. Press the Charge button on the defibrillator keypad or on the right (Apex) paddle.
 - b. Wait for the Charge Done indicators (Charge indicator lights; also, Charge Done tone sounds, if enabled (setup)). When the unit is armed, the monitor display shows the available energy in joules.
 - c. If the defibrillator does not arm:
 - Check that the paddles connector is seated and latched.
 - Verify that the Energy Select control is set properly.
 - To increase or decrease the selected energy level after pressing the **Charge** key, perform these steps:
 - Move the Energy Select control to the new energy level.
 - Wait for the Charge Done indication, as described above.

Warning



Keep hands clear of the paddle electrode edges. Use your thumbs to depress the Shock buttons on the paddle handles.

3. **Shock**

Press and briefly hold both Shock buttons (one on each paddle) simultaneously, to deliver energy to the paddles.

 - a. If the defibrillator does not shock, make sure the unit is not in synchronized shock mode; the **Sync** light is on while the unit is in synchronized shock mode, and SYNC is displayed on the screen. In synchronized mode, the unit will only shock when it detects the next R-wave. In defibrillator mode, the unit shocks when it is armed and you press the Shock buttons. Press **Sync** to change between synchronized mode and defibrillator mode.

Note



To disarm the charged defibrillator, turn the Energy Select control to **Monitor On**. Any stored energy is discharged internally; the available energy shown on the display decrements; when discharge is complete, the displayed available energy becomes blank, and **DEFIB DISARMED** appears on the display.

When you are finished using the defibrillator, turn the Energy Select control to **Off (Standby)**.

Delivered Energy and Shock Button Functional Test

The following procedure provides a quick functional test of the defibrillator and paddles.

1. Turn the Energy Select control to the 100 joules position.
2. Verify that the adult paddle electrodes are installed.
3. Push the paddles completely into their holders and press either Charge button on the front panel or on the paddle. Wait for the Charge Done indicators.

Warning



Keep hands clear of the paddle electrode edges. Use your thumbs to press the shock buttons on the paddle handles

4. With the paddles still in their holders on the defibrillator, grasp the paddle handles and press the Apex paddle Shock button. Verify that the defibrillator does not discharge.
5. Release the Apex paddle shock button and, then press the Sternum paddle Shock button. Verify that the defibrillator does not discharge.
6. Press Sync to place the defibrillator in sync mode.
7. Press and hold both Shock buttons. Verify that the defibrillator does not discharge.
8. Press Sync again to remove the defibrillator from sync mode.
9. With the paddles securely in their holders, press and briefly hold both shock buttons at once. A brief recorder run prints the test results.

Refer to the user's guide for information on using the external adhesive pads that are available for the defibrillator.

Monitoring

The defibrillator can be used for cardiac monitoring (short-term or long-term), elective cardioversion, and pacing (optional). A fully-charged battery provides a minimum of 2.5 hours of continuous monitoring. For unlimited periods of monitoring, connect the unit to AC power.

See the user's guide for information about the different leads that can be used for cardiac monitoring, and which ECG source to select. To monitor a patient's ECG with the defibrillator, follow these steps:

1. Prepare the patient.
2. Turn the Energy Select control to the **Monitor On** position.
3. Press **Lead Select** to select the ECG source. The selected source appears in the upper-right corner of the display.

Note



If the message LEADS OFF or PADS OFF appears on the display, check the electrodes, patient cable, leadwires, and associated connections. If the selected ECG source is not connected, a dashed line replaces the normal ECG trace on the display.

4. Check that the ECG size has automatically adjusted to the optimal size. To reduce the ECG size, press **▼ ECG Size**. The “gain bar” along the left side of the display represents 1 mV of signal amplitude.

Note



Autogain automatically adjusts ECG size when the instrument is turned on. To temporarily disengage Autogain, press **▼ ECG Size ▲**; now, you must adjust the ECG size manually. To reinstate Autogain, turn the instrument to **Off (Standby)** and then back to **Monitor On**.

5. Adjust the QRS beeper volume to the desired volume.
6. For heart rate alarms, three sets of limits are available (their values are configurable in setup—XL+ only). To choose a set of limits, press **HR Alarm** until the desired limits are displayed. The limits become active and are replaced by a bell symbol (🔔).

If the heart rate exceeds the HR alarm limits, the HR alarm limits replace the bell symbol on the display, and the violated limit is highlighted. Pressing **HR Alarm** at this point turns off the HR alarms.

If the HR Alarms are active (bell symbol is displayed) and you wish to review the limits, press **HR Alarm** until the desired pair of limits is displayed. (Pressing **Hr Alarm** repeatedly cycles through the three pairs of HR alarm limits.)

Note



HR alarms are automatically turned off when you press **Charge**.

7. If the HR Alarms are disabled, a no bell symbol (▲) replaces the limits on the display.

Event Summary Record (XL+ only)

During use, the unit stores up to 28 strips of critical ECG information, called events. Events include all shocks, heart rate alarms, and mark events. Each event record includes date of event, heart rate, ECG source, and size setting, as listed in Table 3-7. The time annotated on the ECG strip is within 8 seconds of the recorded event. The message “ES” is printed at the top of the ECG strip when you print the Event Summary record.

Table 3-7. Event Summary Record Information

Event	Event Summary Description
Shock	Shock number (delivered energy, peak current, and patient impedance) or selected energy, depends on setup.
Heart Rate Alarms violation	Heart Rate Alarm limits.
Mark	Marker symbol (▼) annotates strip at point Mark was pressed.

- To print the Event Summary on the recorder, press **Review**. The recorder must not already be printing when you press **Review**.

Note



The Event Summary requires ten seconds after the last event occurrence to complete the event storage. Do not turn the defibrillator off immediately after a shock, HR alarm, or mark, or the event will not be stored.

- To stop the Event Summary record printout, press **Review** or **Record**.
- To review the Event Summary at a later time, turn the unit back on and press **Review**.

Note



The Event Summary record is cleared only when the defibrillator is turned on and a new event occurs. This allows you to turn the defibrillator off, and return later to review the code statistics prior to using the instrument again.

Turn the defibrillator off between uses to ensure that the Event Summary is reset with the new event occurrence. This ensures that event records are only for the current patient.

Recording

To print a record of the current ECG and the monitor status, press

Record.

- The upper line of the ECG strip contains a periodic report of monitor parameters (Date, Time, Heart Rate, ECG Source, ECG Size, and Recorder mode).
- The lower line of the strip records asynchronous events, such as Shock delivery or Heart Rate Alarm violations.
- Several graphic symbols are used to annotate events, such as Shock, HR Alarms, Mark, or Sync.

The recorder can be configured for either monitor or diagnostic ECG bandwidth data. Delayed (6 seconds) or non-delayed operation is also configurable. See Chapter 2, **Installation and Configuration**, for detailed information.

Automatic Recordings

You can enable or disable any of the following automatic recordings:

- Record on Mark
- Record on Charge
- Record on Shock
- Record on Alarms

The automatic recordings for both delayed and non-delayed recorder modes of operation are defined in Table 3-8.

Table 3-8. Automatic Recordings

Event	Delayed Mode Pre-event Time	Delayed Mode Post- event Time	Non-delayed Mode Post-event Time
Mark pressed	6 seconds	3 seconds	3 seconds
Charge pressed	6 seconds	Until Shock or Disarm event	Until Shock or Disarm event
Shocking the patient	6 seconds	12 seconds	12 seconds
HR Alarms violation	6 seconds	6 seconds	6 seconds
Disarm	6 seconds	3 seconds	3 seconds
Test discharge	N/A	3 seconds	3 seconds

Post Shock Data

You can enable or disable the recording of post-shock statistics using the setup menus.

- If Post Shock Data is *enabled*, the defibrillator records the shock delivery statistics (actual delivered energy, patient impedance, and peak current).
- If Post Shock Data is *disabled*, the recorder records the energy level to which it charged (in place of the delivered energy). For example, if the unit was charged to 200 J, the delivered energy annotation on the ECG strip would be 200J.

Recorder Errors

The message CHECK RECORDER appears if an error occurs while recording. If this message appears, check the recorder paper supply. The message may also appear if the recorder door is open.

Synchronized Cardioversion

When the patient is already connected to bedside monitoring equipment, there is a cable which plugs into the ECG output jack of the bedside monitor and connects to the defibrillator for monitoring.

To perform synchronized cardioversion, follow these steps:

1. Plug the input end of the cable from the monitoring equipment into the ECG input plug on the defibrillator.

Warning



When possible, we recommend that synchronized cardioversion procedures are performed while directly monitoring the patient through the defibrillator pads or leads inputs. If an external monitor is used as the ECG source, the monitor and CodeMaster XL or XL+ combination should deliver a synchronized shock within 60 ms of the R-wave peak. This performance cannot be guaranteed with all commercially available monitors. To check performance with an external monitor, see Chapter 4, *Performance Verification and Maintenance*, for detailed information.

2. Turn the Energy Select control to **Monitor On**.
3. Select the desired ECG lead by pressing **Lead Select**.
4. Press **Sync** once to place the instrument in synchronized cardioversion mode. The message SYNC appears on the display.

Note



If the paddles are selected as the ECG source, the message USE LEADS appears on the display. Although the instrument allows synchronized shock in paddles ECG mode, leads mode is recommended. Artifact induced by moving the paddles may resemble an R-wave and trigger defibrillator shock.

5. Cardioversion can be performed with the instrument in Autogain mode. Inspect the displayed ECG before delivering the shock, and verify that an R-wave marker (indicating shock point) appears only with each R-wave. If a marker dot does not appear, or if a marker dot is viewed on the T-wave segment of the ECG, follow these instructions:
 - Adjust the ECG size by pressing **▼ ECG Size ▲** until the marker dot appears only with each R-wave.
 - Select a different lead or adjust the electrode placement, if necessary, to improve ECG R-wave quality.
6. Select the desired energy level with the Energy Select control.
7. Prepare the paddles, apply paddles to patient, and adjust paddles contact. See user's guide for detailed information.
8. Press the **Charge** button on either the right (Apex) paddle or on the instrument keypad. Wait for the Charge Done indicators, and for the display to read the desired energy level.
9. Press and hold both Shock buttons (one on each paddle) until shock occurs. The defibrillator will shock with the next detected R-wave.
10. If additional shocks are required, readjust the Energy Select control as necessary, and repeat the synchronized cardioversion procedure.

Note



After synchronized cardioversion, the unit will either remain in the synchronized shock mode or it will return to the defibrillator mode after shock. The mode depends on the MODE AFTER CV selection in setup. See Chapter 2, **Installation and Configuration**, for detailed information.

After using the defibrillator, turn the Energy Select control to **Off (Standby)**; plug the power cord into an AC power outlet and verify that both the **BATT CHRG** and **AC POWER** indicators are lit.

Pacing (XL+ Only)

The XL+ defibrillator with pacer option can perform external transcutaneous pacing. The pacing option provides demand (synchronous) and fixed (asynchronous) pacing modes. The patient is connected to the pacer by multifunction adhesive pads for external use; the patient can be paced and defibrillated through the same set of pads.

Warning



To prevent receiving an electrical shock, do not touch the gelled area of the pacing pads or the patient.

Use only HP-recommended multifunction pads with the external pacer option. The instrument delivers pacer pulses through a low-impedance multifunction pad. The instrument will not pace effectively with high-impedance, pace-only electrodes.

Do not use multifunction pads for more than eight hours of continuous pacing.

The instrument will pace on battery power alone. However, when possible, plug the unit into AC power while pacing.

To use the pacer, follow these steps:

1. Apply pads; see the *CodeMaster User's Guide* for detailed information.
2. Attach the patient cable to the instrument's ECG Input connector.
3. Attach the patient cable leads to the monitoring electrodes.
4. Attach the pads interface cable (M1750A/B) to the defibrillator output connector. Pull the latch connector toward the front of the defibrillator to lock the connector in place.
5. Attach the pads to the pads interface cable and turn the twist lock.
6. Turn the Energy Select control to the **Monitor On** position.
 - If the message **NO PADDLES** appears, check that the pads interface cable connector is properly seated and latched.
 - If the message **PADS OFF** appears, check the pads connection to the patient and to the pads interface cable.
7. Press **Pacer On** to turn the pacer on. Pacer parameters will now be displayed at the bottom of the display:
 - **PACER STOP**
 - **DEMAND MODE**
 - **70 PPM 30 MA**

The rate (ppm) and output (mA) settings that are displayed when the pacer is turned on are the values selected in setup. To change these initial values, see Chapter 2, **Installation and Configuration**. The original rate and output settings from the factory are 70 ppm and 30 mA.

The pacer is always in demand mode when it is initially turned on. You can change the mode by pressing **Mode** only while the pacer output is off (PACER STOP is shown on the display). If the message PACING is displayed, press **Start/Stop** to turn the pacer output off. You can then change the mode.

Note



At this point, no pacer pulses are being delivered to the patient. The pacer must be started by pressing **Start/Stop**, before pacer pulses are delivered at the selected rate and output.

8. Press **Lead Select** to select the best Lead for monitoring while pacing. You can only select Leads as the ECG source when the pacer is on.
 - If the message LEADS OFF is displayed, check all patient cable connections. The pacer will not operate in demand mode if the leads are off.
9. Press **▼ Rate ▲** to adjust the pulse rate. The selected rate (ppm) is displayed on the monitor.
10. Press **Mode** to select the pacing mode (demand mode or fixed mode). The selected mode is displayed on the monitor.
 - In demand mode, the pacer delivers pacer pulses only when the patient's heart rate is lower than the selected pacer rate.
 - In fixed mode, the pacer delivers pacer pulses at the selected pacer rate.

Warning



Use demand pacing mode whenever possible. Use fixed pacing mode (asynchronous) when reliable monitoring of the patient is impractical. For example, use fixed mode when there is motion artifact or other ECG noise that makes R-wave detection unreliable. (You can change the mode only when the pacer is stopped.)

11. Press **Start/Stop** to start pacing. The monitor displays the message PACING, and displays the selected mode, rate, and output level.

The pacer will not start pacing if there is a problem with either the pacing pad connections or the monitoring electrode connections in demand mode.

If there is a problem with the pacing pad connection, the message ATTACH PADS is displayed briefly when you press **Start/Stop**.

12. Verify that the pacer pulses are well-positioned in the diastole. Changing leads can help to determine capture.
13. To achieve capture, increase output (mA) by pressing **Output ▲** until the beat is captured.
14. To set the lowest possible output level to capture, decrease the current by decrements of 5 mA by pressing **▼ Output**.

Note



If the monitoring ECG lead falls off while pacing in demand mode, the pacer stops delivering pulses and the messages PACER STOP and LEADS OFF appear. A continuous alarm sounds; pressing any key will silence the alarm. To resume pacing, re-attach the lead and press **Start/Stop**.

Pacing in fixed mode does not require leads to be attached for the pacer to deliver pulses.

If a pacing pad comes off during pacing, the pacer stops delivering pulses and the messages PACER STOP and PADS OFF appear. A continuous alarm sounds; pressing any key will silence the alarm. To resume pacing, re-attach the pad and press **Start/Stop**.

Warning



HR meters and HR alarms function during pacing, but they can be unreliable. The HR meter attempts to count QRS activity in both demand and fixed pacing modes. Observe the patient closely while pacing. Do not rely on HR alarms or the indicated heart rate as a measure of the patient's health.

The patient can be defibrillated during pacing; see the user's guide for detailed instructions.