

***POWER PAC 1000***  
**AND**  
***POWER PAC 3000***  
**INSTRUCTION MANUAL**

**Catalog Numbers**

**PowerPac 1000**

**165-5054**

**165-5055**

**PowerPac 3000**

**165-5056**

**165-5057**

**165-5058**

**165-5059**

**165-5060**

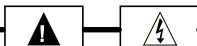
**BIO-RAD**

## **TABLE OF CONTENTS**

<b>Safety</b> .....	2
<b>Section 1.0 Introduction</b> .....	4
1.1 Overview .....	4
1.2 Features .....	5
1.3 Unpacking .....	5
<b>Section 2.0 Control Features</b> .....	6
2.1 Front Panel controls .....	6
2.2 Rear Panel .....	7
<b>Section 3.0 Manual Mode Operation</b> .....	8
<b>Section 4.0 Program Mode Operation</b> .....	12
4.1 Create and Run a Method .....	13
4.2 Edit and Run a Method .....	16
4.3 View a Method .....	18
4.4 Run a Method .....	19
<b>Section 5.0 Temperature Mode Operation (PowerPac 3000 only)</b> .....	22
<b>Section 6.0 Maintenance and Troubleshooting</b> .....	27
6.1 Maintenance .....	27
6.2 Troubleshooting .....	27
<b>Appendix A. Specifications</b> .....	30
<b>Appendix B. Warranty and Ordering Information</b> .....	33
<b>List of Figures</b>	
1. PowerPac 3000 Power Supply .....	4
2. PowerPac Rear Panel .....	7
3. Manual Mode Flow Chart .....	11
4. Create Method Flow Chart .....	15
5. Display while Programmed Method is in Progress .....	20
6. Display upon Completion of Method .....	21
7. Temperature Mode Flow Chart (PowerPac 3000 only) .....	26
<b>List of Tables</b>	
1. Front Panel Controls .....	6
2. Manual Mode Operation .....	8
3. Preliminary Setup Procedure .....	12
4. Procedure for Creating and Running a Method .....	13
5. Procedure for Editing and Running a Method .....	16
6. Procedure for Viewing a Method .....	18
7. Procedure for Running a Stored Method .....	19
8. Temperature Mode Operation (PowerPac 3000 only) .....	22
9. Examples of Power Requirements .....	25

## SAFETY

---



### Caution/Warning

PowerPac power supplies use high output voltages that are electrically isolated from earth ground to minimize the risk of electrical shock to the user. The following guidelines should be observed and followed when using a PowerPac power supply.

PowerPac power supplies have passed tests for operation at temperatures between 0° and 40° C, with relative humidity between 0 and 95% non-condensing. Operating the power supply outside these conditions is not recommended by Bio-Rad and will void the warranty.

---

1. To ensure adequate cooling of the power supply, be sure that there is at least 6 cm clearance around the power supply. Do not block the fan vents at the rear of the unit.
2. Always connect the power supply to a 3-prong, grounded AC outlet, using the 3-prong AC power cord provided with the power supply.
3. Bio-Rad electrophoresis cells have molded two-prong plugs which are inserted into the power supply's high voltage output jacks. These plugs have been I.E.C. 1010 certified for safety compliance for use with PowerPac power supplies. Use of other plugs or banana jacks is done at the user's own risk and is not recommended by Bio-Rad. When inserting and removing the molded two-prong plug, always grasp the plug by the molded support at the rear of the plug. Do not grasp the individual prong ends!
4. Do not operate the power supply in extreme humidity ( $\geq 95\%$ ) or where condensation can short the internal electrical circuits of the power supply.
5. When taking the power supply into a cold room, the unit can be operated immediately. However, when removing the power supply from the cold room, let the unit equilibrate to room temperature for a minimum of 2 hours before using it.
6. Never connect a high voltage output lead to earth ground. This defeats the floating electrical isolation of the power supply and exposes the user to potentially lethal high voltages. The PowerPac will detect ground leakage and automatically shut down the power supply.
7. The PowerPacs are designed to detect electrical arcing of the high voltage cables and to automatically shut down.

**Important**

This instrument is intended for laboratory use only.

This product conforms to the class A standards for Electromagnetic Emissions, intended for laboratory equipment applications. It is possible that emissions from this product may interfere with some sensitive appliances when placed nearby or on the same circuit as those appliances. The user should be aware of this potential and take appropriate measures to avoid interference.

Bio-Rad's PowerPac power supplies are designed and certified to meet I.E.C. 1010\* safety standards. Certified products are safe to use when operated in accordance with the instruction manual. This safety certification does not extend to electrophoresis cells or accessories which are not I.E.C. 1010 certified, even when connected to this power supply.

This instrument should not be modified or altered in any way. Alteration of this instrument will void the manufacturer's warranty, void the I.E.C. 1010 certification, and create a potential safety hazard for the user.

Bio-Rad is not responsible for any injury or damage caused by the use of this instrument for purposes other than those for which it is intended, or by modifications of the instrument not performed by Bio-Rad or an authorized agent.

\*I.E.C. 1010 is an internationally accepted electrical safety standard for laboratory instruments.

## 1.0 INTRODUCTION

### 1.1 OVERVIEW

PowerPac power supplies provide constant voltage, power, and current for electrophoresis applications. The PowerPac 3000 is ideal for DNA sequencing, isoelectrofocusing (IEF), and electrophoresis; the PowerPac 1000 may be used for most isoelectrofocusing (IEF) applications, blotting, and general electrophoresis. Either PowerPac can be used also for SDS-PAGE, two-dimensional electrophoresis, native gel electrophoresis, and horizontal DNA/RNA electrophoresis.

#### PowerPac 1000

Voltage output: Adjustable from 5 to 1000 volts dc (VDC) in increments of 1 volt.  
Current output: Adjustable from 1 to 500 milliAmps (mA) in increments of 1 mA.  
Power output: Adjustable from 1 to 250 watts (W) in increments of 1 W

#### PowerPac 3000

Voltage output: Adjustable from 25 to 3000 volts dc (VDC) in increments of 1 volt.  
Current output: Adjustable from 1 to 400 milliAmps (mA) in increments of 1 mA.  
Power output: Adjustable from 1 to 400 watts (W) in increments of 1 W

The PowerPac 1000 and PowerPac 3000 are fully programmable, with the capacity to store up to 9 separate methods, with each method consisting of up to 9 steps. PowerPac default limit values for voltage, current, and power are displayed when the unit first is turned on. These values may be changed for each application. PowerPac power supplies can run continuously, or they can be programmed to run under time or volt-hours control. Up to four electrophoresis cells can be connected to a power supply.

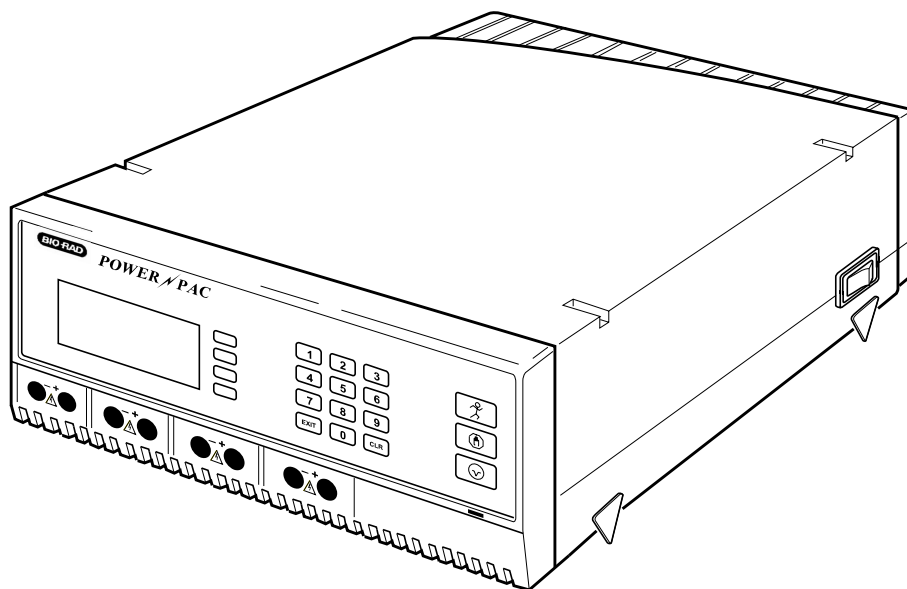


Figure 1. PowerPac 3000 Power Supply

PowerPac power supplies operate at the value specified by the constant parameter. However, to prevent damage to your electrophoresis cell, PowerPacs provide automatic crossover to either constant current, constant voltage, or constant power, depending on which set value is first reached. When the set limit of a non-constant parameter is reached, and the power capability of the unit is not exceeded, the power supply will switch, making the non-constant parameter the new constant parameter.

## **1.2 FEATURES**

PowerPac power supplies offer a number of features, including the following:

- Constant voltage, constant power, or constant current operation with automatic crossover.
- Continuous, timer, or volt-hour control.
- Manual and Program modes of operation. In addition, the PowerPac 3000 offers Temperature mode operation.
- I.E.C. 1010 international safety certification.
- Automatic detection of no-load, rapid change in resistance, arcing, short circuit, and ground leakage.
- Automatic completion (if desired) of a run interrupted by a power failure.
- Backlit LCD graphics display.
- Stackable case.
- Viewing angle adjustment provided by two position leg.

## **1.3 UNPACKING**

When you receive the power supply, carefully inspect the container for any damage which may have occurred in shipping. Severe damage to the container may indicate damage to the power supply itself. If you suspect damage to the unit may have occurred, immediately file a claim with the carrier in accordance with their instructions before contacting Bio-Rad Laboratories.

Unpack the power supply. PowerPac power supplies are shipped with the following:

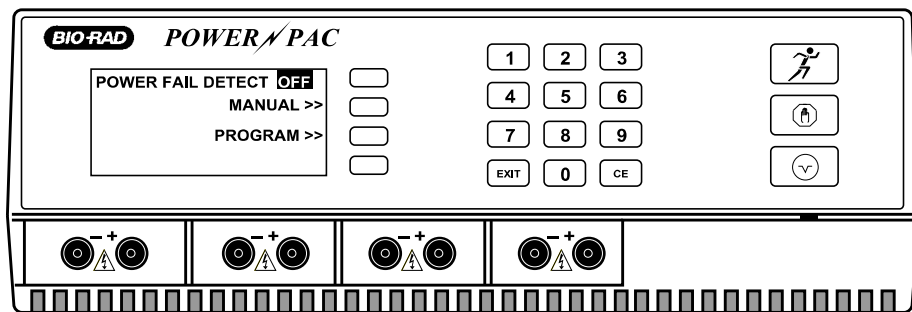
- Power supply unit.
- 3-prong, AC power cord.
- User Manual.

If any part is missing or damaged, contact Bio-Rad Laboratories immediately.

## 2.0 CONTROL FEATURES

### 2.1 FRONT PANEL CONTROLS

Table 1.  
Front Panel Controls









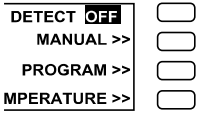
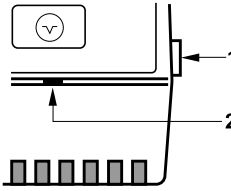
Key	Description
	<b>Start key:</b> Starts a run.
	<b>Stop key:</b> Stops the run which is currently in progress. The end of run parameters are displayed.
	<b>Pause key:</b> Interrupts a run. The LCD displays the voltage, current and power at the time the key was pressed. Power output is stopped. The run parameters cannot be changed during a pause. To resume the run, press the  key.
	<b>Exit key:</b> Returns you to the main menu.
	<b>Clear Entry key:</b> Allows you to clear or re-enter the displayed value.

Table 1. (continued)  
Front Panel Controls

Key	Description
	<p><b>Soft keys:</b> Allow you to select that parameter or execute that command on the graphic display which is located adjacent to its key.</p> <p><b>Note:</b> Temperature mode is available only with the PowerPac 3000, and it requires that the Temperature Probe be attached.</p>
	<ol style="list-style-type: none"> <li><b>Power switch:</b> Turns the power supply on and off. To turn the unit on, press the side labeled "I" on the switch; to turn the unit off, press the side labeled "O".</li> <li><b>Power-on indicator:</b> This is lit when the power switch is turned on.</li> </ol>

2.2 REAR PANEL

Figure 2 shows the following:

1. Fan vents, for cooling the unit.
2. AC power input connector.
3. Temperature probe jack (PowerPac 3000 only).
4. RS-232 serial port (PowerPac 3000 only). This is reserved for a future option.

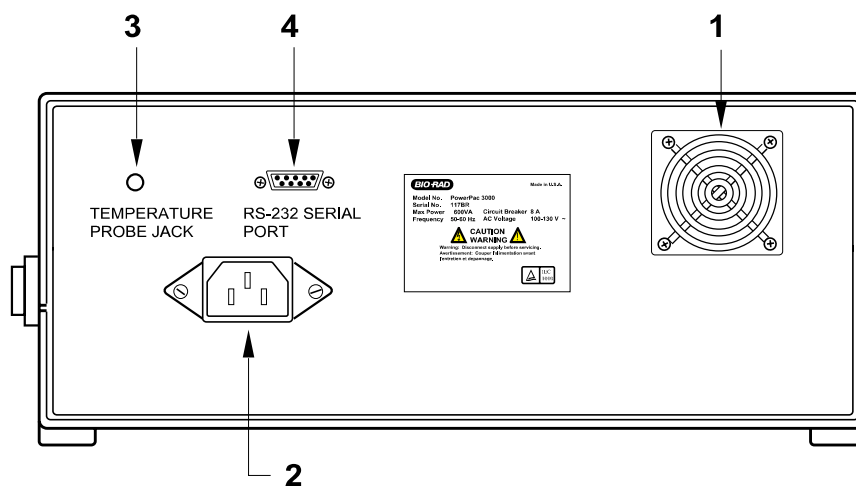




Figure 2. PowerPac 3000 Rear Panel

### 3.0 MANUAL MODE OPERATION

PowerPac power supplies may be operated automatically using pre-defined methods, or may be run manually at a specified voltage, current, or power. The PowerPac 3000 may also be programmed to run at a specified temperature. This chapter discusses Manual mode, in which the power supply is operated using one set of parameters only.









**Table 2.**  
**Manual Mode Operation**

Step	Procedure	Description
1.	Connect the electrophoresis cell(s) to the power supply.  	The power leads are color coordinated to the output terminals.   indicates high voltages may be present.
2.	Turn on the power.	a. Press the <b>Power</b> switch, located on the side of the unit. (Press the side labeled "I" on the switch.) Note that the copyright screen and the firmware version number appear briefly when the unit is turned on. b. The main menu is displayed, as shown below:  <div style="border: 1px solid black; padding: 5px; width: fit-content;">                         POWER FAIL DETECT <input checked="" type="checkbox"/> OFF                          MANUAL &gt;&gt; <input type="checkbox"/>                          PROGRAM &gt;&gt; <input type="checkbox"/> </div>
3.	(Optional) Set <b>POWER FAIL DETECT</b> from the main menu.	Press the appropriate soft key.  In the event of a power failure, all operating parameters including time are retained in memory. When power is restored, the power supply <i>automatically</i> completes the run. After the run is completed, an error message is displayed to alert the operator that a power failure occurred.

**Table 2. (continued)**  
**Manual Mode Operation**

Step	Procedure	Description
4.	Select <b>Manual</b> .	Press the appropriate soft key.
5.	Select the constant parameter.	Use the soft key to select either constant voltage (V), constant current (mA), or constant power (W).
6.	Enter the constant value.	Use the numeric keypad to enter a value. To make changes, press the <input type="button" value="CE"/> key and re-enter the value.
7.	Change the default limits, if desired	<p>To change these limits, select the limit using its soft key and enter a value using the keypad. If you make a mistake when entering a value, press the <input type="button" value="CE"/> key and re-enter the value.</p> <p><b>PowerPac 1000</b>            Constant voltage: The default limits are 500 mA and 250 W.            Constant current: The default limits are 1000 V and 250 W.            Constant power: The default limits are 1000 V and 500 mA.</p> <p><b>PowerPac 3000</b>            Constant voltage: The default limits are 400 mA and 400 W.            Constant current: The default limits are 3000 V and 400 W.            Constant power: The default limits are 3000 V and 400 mA.</p>
8.	Select <b>TIME/V-HOUR</b> to continue.	Press the appropriate soft key.

**Table 2. (continued)  
Manual Mode Operation**

Step	Procedure	Description
9.	Select one of the following:  a. TIME          b. V-HOUR          c. Press  to start the run.	a. TIME: To specify automatic time control. You may then enter a time from 1 minute to 99 hours and 59 minutes. After you have entered a value, press  to start the run.  b. V-HOUR: To specify automatic volt-hour control for the run. You may then enter a value from 1 to 99,999 volt-hours. Volt-hours is the integration of voltage as a function of time. By programming the unit to run for a specified number of volt-hours, you get more accurate run-to-run reproducibility. After you have entered a value, press  to start the run.  c. Pressing  will start the run. The run will continue until you stop it, or the run is completed.  <b>Note:</b> The run may be stopped at any time using either of the following keys:   Stops the run and displays the end-of-run parameters.   Interrupts operation of the power supply until the  key is pressed. During the pause, the LCD display shows the status of the run at the time the key was pressed. Run parameters cannot be changed during a pause. If you do not wish to continue the run, press the  key.

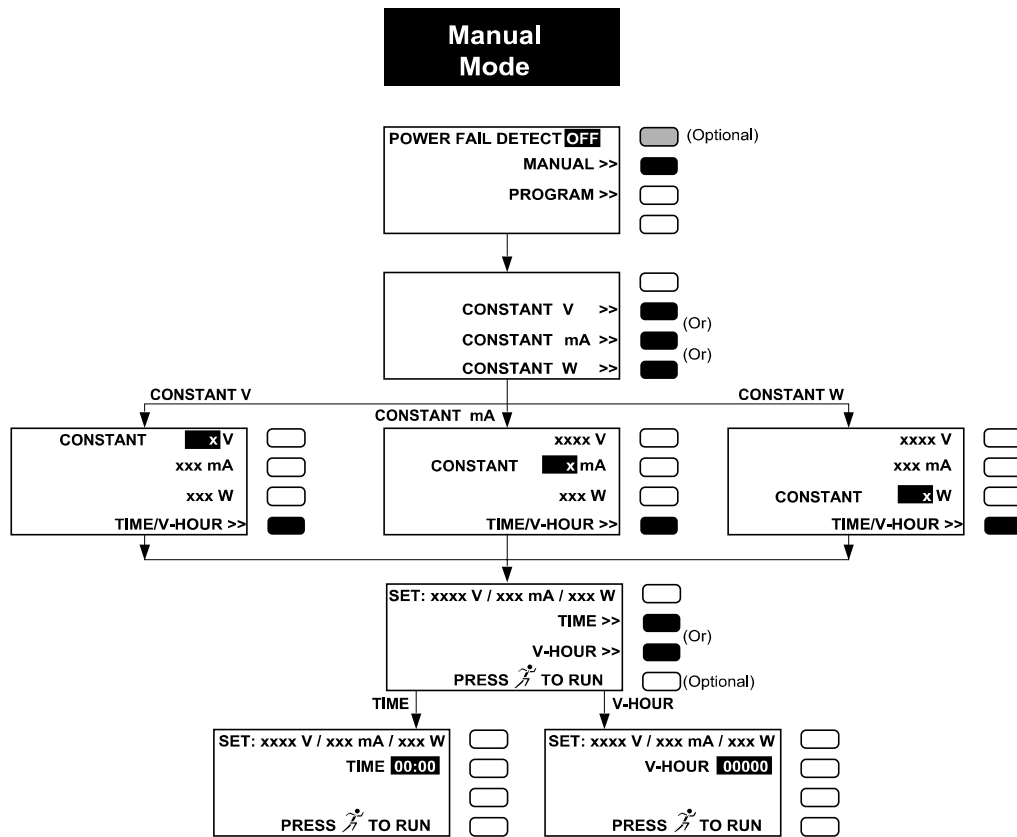


Figure 3. Manual Mode Flow Chart



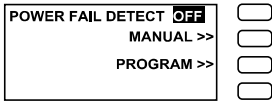
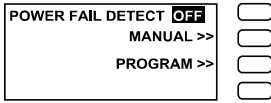
## 4.0 PROGRAM MODE OPERATION

There are four selections under Program mode:

- Create a method
- Edit a method
- Run a method
- View a method

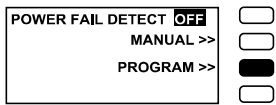
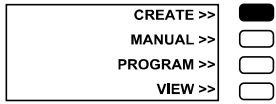
Each of these selections is discussed in the following sections. To start, follow the procedure in Table 3, Preliminary Setup Procedure.

**Table 3.**  
**Preliminary Setup Procedure**








Step	Procedure	Description
1.	Connect the electrophoresis cell(s) to the power supply. 	The power leads are color coordinated to the output terminals.  indicates high voltages may be present.
2.	Turn on the power.	a. Press the <b>Power</b> switch, located on the side of the unit. (Press the side labeled "I" on the switch.) b. The main menu is displayed, as shown below: 
3.	(Optional) Set <b>POWER FAIL DETECT</b> from the main menu. 	Press the appropriate soft key.  In the event of a power failure, all operating parameters including time are retained in memory. When power is restored, the power supply <i>automatically</i> completes the run. After the run is completed, an error message is displayed to alert the operator that a power failure occurred.

4.1 CREATE AND RUN A METHOD

**Table 4.**  
**Procedure for Creating and Running a Method**

Step	Procedure	Description
1.	Select <b>PROGRAM</b> from the main menu. 	This procedure assumes you have set up the unit as discussed in Table 3, Preliminary Setup Procedure, at the beginning of this chapter.  The Program menu lists the following: CREATE, EDIT, RUN, and VIEW.
2.	Select <b>CREATE</b> to generate a new method. 	Each step is defined by the following parameters: <ul style="list-style-type: none"> <li>• Constant, which may be voltage, current or power.</li> <li>• Duration, which may be Time or Volt-hours.</li> </ul>
3.	Specify the constant parameter for the step.	Select voltage (V), current (mA), or power (W) as the constant value.
4.	Enter the constant's value.	Use the keypad to enter a value.
5.	Change the default limits, if desired.	To change these limits, select the limit to be changed and enter a value using the numeric keypad.  <b>PowerPac 1000</b> Constant voltage: The default limits are 500 mA and 250 W. Constant current: The default limits are 1000 V and 250 W. Constant power: The default limits are 1000 V and 500 mA.  <b>PowerPac 3000</b> Constant voltage: The default limits are 400 mA and 400 W. Constant current: The default limits are 3000 V and 400 W. Constant power: The default limits are 3000 V and 400 mA.
6.	Program a run controlled by time or volt-hours.	Select <b>TIME/V-HOUR</b> . You <b>must</b> specify time or volt-hours for each step.
7.	Enter a value for time or volt-hours.	<b>TIME:</b> Enter a value from 1 minute to 99 hours 59 minutes.  <b>V-HOUR:</b> Enter a value up to 99,999 volt-hours. Volt-hours is the integration of voltage as a function of time.

**Table 4. (continued)**  
**Procedure for Creating and Running a Method**

Step	Procedure	Description
8.	Program the next step or save the program.	Select either of the following: a. If you are defining another step, select <b>ADD STEP</b> . Repeat procedures 3 through 6 above. b. If your method is complete, select <b>SAVE PROGRAM</b> .
9.	Enter the method number.	Using the keypad, select a number from 1 to 9.  <b>Note:</b> The available method numbers are listed. Choosing a number which is not listed overwrites an existing method.
10.	Start the run or exit to the main menu.	To start the run using the method's new parameter values, press  .  Figure 5 shows the contents of the Run screen. Figure 6 shows the contents of the screen after completion of a run.  To quit and return to the main menu, press the <b>Exit</b> key.
11.	To stop the run at any time, press either of the following keys:  	The following keys can be used to stop the run before it is completed:   Stops the run and displays the end-of-run parameters.   Interrupts operation of the power supply until the  key is pressed. During the pause, the LCD display shows the status of the run at the time the key was pressed. Run parameters cannot be changed during a pause. If you do not wish to continue the run, press the  key.

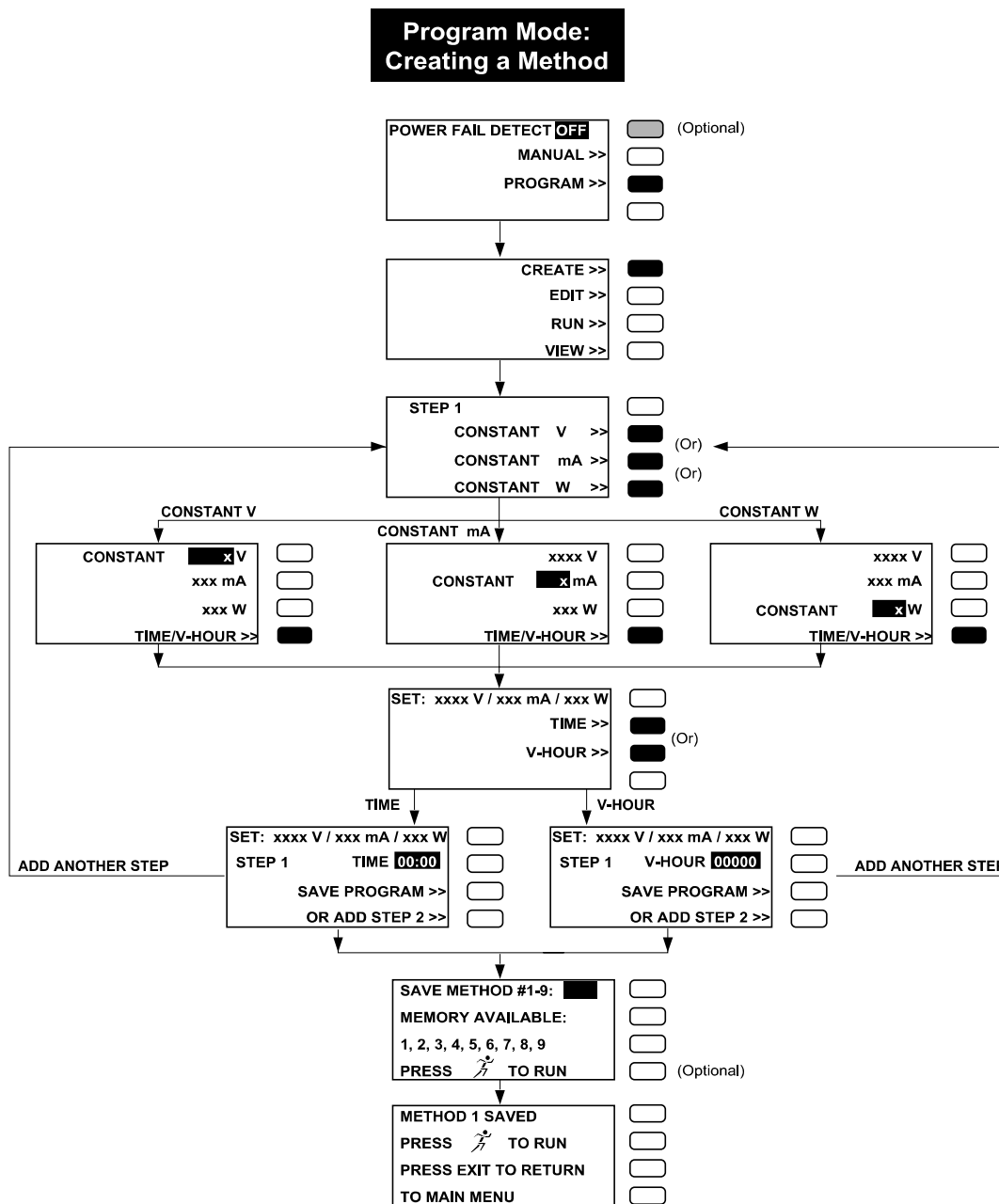
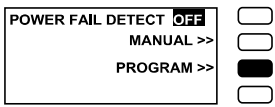


Figure 4. Create Method Flow Chart








## 4.2 EDIT AND RUN A METHOD

The Edit selection of the Program mode allows you to change an existing method.

**Table 5.**  
**Procedure for Editing and Running a Method**

Step	Procedure	Description
1.	Select <b>PROGRAM</b> from the main menu. 	This procedure assumes you have set up the unit as discussed in Table 3, Preliminary Setup Procedure, at the beginning of this chapter.  The Program menu lists the following: CREATE, EDIT, RUN, and VIEW.
2.	Select <b>EDIT</b> and the number of the method to be edited.	After you select <b>EDIT</b> , the list of available methods is displayed.
3.	Select the constant parameter for the step.	You must select either power, voltage, or current. The programmed constant parameter is highlighted.
4.	Change the parameter values, if desired.	Select the appropriate parameter, and enter its value using the keypad. Note that the constant parameter is displayed on the screen.
5.	Change the programming for a timed step.	a. Select <b>TIME</b> or <b>V-HOUR</b> . The programmed parameter is highlighted.  b. Modify the value of the selected parameter: <ul style="list-style-type: none"> <li>• <b>TIME</b>: Duration may be from 1 to 99 hours 59 minutes.</li> <li>• <b>V-HOUR</b>: From 1 to 99,999 V.</li> </ul>
6.	Edit the next step or quit the editing function.	Select either of the following: <ol style="list-style-type: none"> <li>a. Select <b>ADD STEP</b>. If you are editing additional steps or adding a step, repeat procedures 3 through 5 above.</li> <li>b. Select <b>SAVE PROGRAM</b>.</li> </ol>

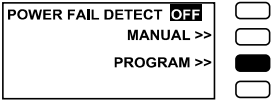
**Table 5. (continued)**  
**Procedure for Editing and Running a Method**

Step	Procedure	Description
7.	Enter the method number.  Note: If you select a method number different from that which you selected to edit, both the original method and the new method will be saved.	Make your selection based on the following: <ul style="list-style-type: none"> <li>• To save the original method and all its parameter values, select a number different from that of the method being edited. This in effect creates a new method.</li> <li>• To overwrite the method's original parameter values, be sure to select the same method number as that which was selected for editing.</li> </ul> Note that the available method numbers are listed.
8.	Start the run or exit to the main menu.	To start the run using the method's new parameter values, press  .  Figure 5 shows the contents of the Run screen. Figure 6 shows the contents of the screen after completion of a run.  Press the <b>Exit</b> key to return to the main menu.
9.	To stop the run at any time, press either of the following keys:    	The following keys can be used to stop the run before it is completed: <ul style="list-style-type: none"> <li> Stops the run and displays the end-of-run parameters.</li> <li> Interrupts operation of the power supply until the  key is pressed. During the pause, the LCD display shows the status of the run at the time the key was pressed. Run parameters cannot be changed during a pause. If you do not wish to continue the run, press the  key.</li> </ul>

### 4.3 VIEW A METHOD

This selection allows you to quickly view the contents of a stored method.

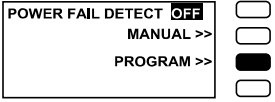
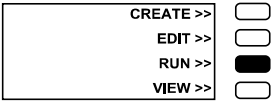







**Table 6.**  
**Procedure for Viewing a Method**

Step	Procedure	Description
1.	Select <b>PROGRAM</b> from the main menu. 	This procedure assumes you have set up the unit as discussed in Table 3, Preliminary Setup Procedure, at the beginning of this chapter.  The Program menu lists the following: CREATE, EDIT, RUN, and VIEW.
2.	Select <b>VIEW</b> and the number of the method to be edited.	After you select <b>VIEW</b> , the list of available methods is displayed. Select the number of the method you want to review, using the numeric keypad to enter a number.
3.	Review the contents of each step in the method.	Press the appropriate soft key.  Press the <b>Exit</b> key to return to the main menu.

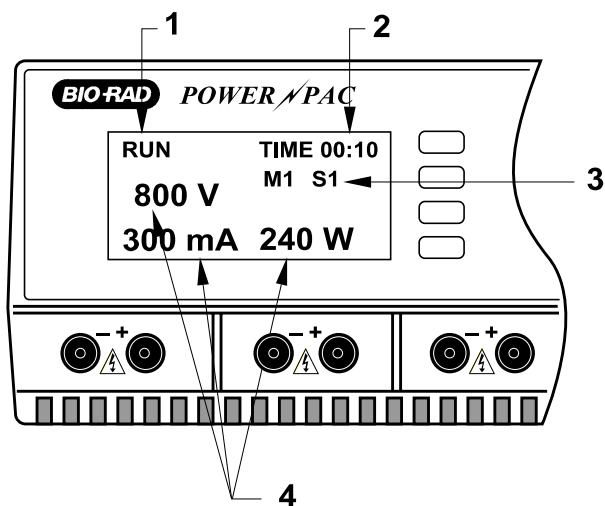
#### 4.4 RUN A METHOD

This procedure allows you to quickly select and run a stored method.

**Table 7.**  
**Procedure for Running a Stored Method**

Step	Procedure	Description
1.	Select <b>PROGRAM</b> from the main menu.  	This procedure assumes you have set up the unit as discussed in Table 3, Preliminary Setup Procedure, at the beginning of this chapter.  The Program menu lists the following: CREATE, EDIT, RUN, and VIEW.
2.	Select <b>RUN</b> .  	Press the appropriate soft key. <ul style="list-style-type: none"> <li>To run an existing method without changes, select <b>RUN</b>.</li> <li>If you want to verify the contents of a method before running it, select <b>VIEW</b> and enter the method's number. This displays the contents of the first step. This procedure is discussed in Table 6.</li> <li>If you have not yet created a method, or if the method you want to run requires modifications, select either <b>CREATE</b> or <b>EDIT</b>. Follow the procedures provided in Tables 4 and 5 for creating and editing methods.</li> </ul>
3.	Enter the method number and start the run.	Press the  key to start operation.  Figure 5 shows the contents of the Run screen. Figure 6 shows the contents of the screen after completion of a run.
4.	To stop the run at any time, press either of the following keys:    	The following keys can be used to stop the run before it is completed: <ul style="list-style-type: none"> <li> Stops the run and displays the end-of-run parameters.</li> <li> Interrupts operation of the power supply until the  key is pressed. During the pause, the LCD display shows the status of the run at the time the key was pressed. Run parameters cannot be changed during a pause. If you do not wish to continue the run, press the  key.</li> </ul>

During operation of the power supply, the LCD display shows the operating parameter values, as shown in Figure 5.



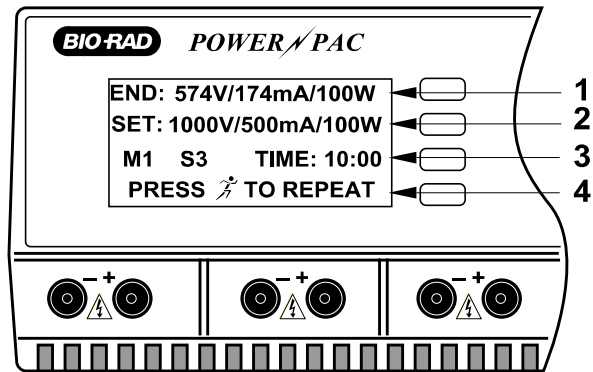
**Legend**

- 1. Status of the run.
- 2. Elapsed time in hours and minutes (or total volt-hours).
- 3. The method (M) and step (S) that is currently running.
- 4. Actual output voltage, current, power.

**Note:** The constant parameter is highlighted.

*Figure 5. Display while Programmed Method is in Progress*

After the programmed time or volt-hours, the power supply automatically continues with the next step or if there is none, it stops. When the method stops running, the final operating parameters, along with the original set parameters of the last step completed, are displayed, as shown in figure 6.



#### Legend

1. Final voltage, current, and power.
2. Programmed voltage, current, and power.
3. Final method (M) and step (S) number and elapsed time.
4. Repeat the run using the same method number.

**Figure 6. Display upon Completion of Method**



## 5.0 TEMPERATURE MODE OPERATION (POWERPAC 3000 ONLY)

Temperature mode allows you to operate an electrophoresis apparatus at a constant temperature. Constant temperature is extremely useful for performing DNA sequencing or single stranded conformational polymorphism (SSCP) analysis. The PowerPac 3000 can maintain gel temperatures anywhere from 0°C to 90°C with an accuracy of ± 1°C.


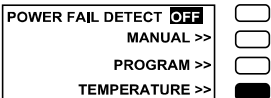
**NOTE:** The PowerPac 3000 controls temperature by regulating temperature as a limit parameter. The PowerPac 3000 will begin to automatically regulate the output of watts to the electrophoresis apparatus when the temperature is within 3°C of the set temperature. However, if the number of watts entered is not enough for the apparatus to reach the set temperature, the PowerPac 3000 will be unable to regulate the temperature of the apparatus. Therefore, it is important to optimize the power conditions required for your particular application to insure that your gel will reach the set temperature. Refer to Table 8 for approximate power requirements for Sequi-Gen® sequencing cell. There is no substitution for optimizing the power conditions required for your particular application and gel apparatus. This will help to ensure that your gel will reach and maintain the set temperature.

To access the PowerPac 3000 constant temperature mode, you will need a PowerPac temperature probe.

**Table 8.**  
**Temperature Mode Operation**

Step	Procedure	Description
1.	Connect the electrophoresis cell(s) to the power supply. 	The power leads are color coordinated to the output terminals.  indicates high voltages may be present.
2.	Connect the temperature probe to the jack on the rear panel of the power supply.	Use the port labeled "Temperature Probe Jack". Figure 2 in section 2.2 shows the location of the temperature probe port.
3.	Turn on the power.	a. Press the <b>Power</b> switch, located on the side of the unit. (Press the side labeled "I" on the switch.) b. The main menu is displayed, as shown below: <div style="border: 1px solid black; padding: 5px; display: inline-block;">                         POWER FAIL DETECT <input checked="" type="checkbox"/> OFF                          MANUAL &gt;&gt; <input type="checkbox"/>                          PROGRAM &gt;&gt; <input type="checkbox"/>                          TEMPERATURE &gt;&gt; <input type="checkbox"/> </div>









**Table 8. (continued)**  
**Temperature Mode Operation**

Step	Procedure	Description
4.	Attach the temperature probe to the apparatus.	<p>Before attaching the temperature probe to the front glass plate of the electrophoresis apparatus, be sure the glass plate is clean to guarantee proper probe attachment. Slowly roll the probe out against the clean glass surface. Firmly press the probe against the plate to secure the seal. If the probe will not remain attached, place a little vacuum grease on the probe before attaching.</p> <p>If the probe becomes dislodged from the glass plate during a run, the temperature control will not work properly.</p> <p>To remove the probe from the glass plate, simply pull on the small tab at the edge of the probe.</p>
5.	(Optional) Set <b>POWER FAIL DETECT</b> from the main menu 	<p>Press the appropriate soft key.</p> <p>In the event of a power failure, all operating parameters including time are retained in memory. When power is restored, the power supply <i>automatically</i> completes the run. After the run is completed, an error message is displayed to alert the operator that a power failure occurred.</p>
6.	Select <b>TEMPERATURE</b> . 	<p>Press the appropriate soft key.</p>

**Table 8. (continued)**  
**Temperature Mode Operation**

Step	Procedure	Description
7.	Enter the desired temperature in degrees centigrade.	The temperature range is 0°C to 90°C.
8.	Select <b>POWER</b> .	Press the appropriate soft key. The power supply will always run constant power while operating in temperature mode, unless there is cross-over.
9.	Enter the power required to maintain the gel at the programmed temperature.  If desired, change the default voltage and current.	Enter the watts required to maintain the gel at the programmed temperature. If desired, change the default voltage and current.  Voltage may be a value between 25 and 3000 V. Current may be a value between 1 and 300 mA. Power may be a value between 1 and 400 W.  <b>Warning:</b> Excessive power will cause a rapid rise in gel temperature, which in turn may crack glass plates as well as make it difficult for the PowerPac 3000 to properly control gel temperature. Refer to Table 9 at the end of this chapter for approximate power requirements.
10.	Select <b>TIME/V-HOUR</b> to continue.	Press the appropriate soft key.

**Table 8. (continued)  
Temperature Mode Operation**

Step	Procedure	Description
11.	Select one of the following:  a. TIME  b. V-HOUR  c. Press  to start the run.	a. TIME: To specify automatic time control. You may then enter a time from 1 minute to 99 hours and 59 minutes. After you have entered a value, press  to start the run.  b. V-HOUR: To specify automatic volt-hour control for the run. You may then enter a value from 1 to 99,999 volt-hours. Volt-hours is the integration of voltage as a function of time. By programming the unit to run for a specified number of volt-hours, you get more accurate run-to-run reproducibility. After you have entered a value, press  to start the run.  c. Pressing  will start the run. The run will continue until you stop it.  <b>Note:</b> The run may be stopped at any time using either of the following keys:   Stops the run and displays the end-of-run parameters.   Interrupts operation of the power supply until the  key is pressed. During the pause, the LCD display shows the status of the run at the time the key was pressed. If you do not wish to continue the run, press the  key.

**Table 9.  
Examples of Power Requirements**

The following table shows approximate power requirements to maintain 50°C using a Bio-Rad Sequi-Gen® sequencing apparatus with 0.4 mm spacer, 5% gel and 1xTBE buffer.

Gel Dimensions	21 x 40 cm	21 x 50	21 x 80	38 x 50
Watts	80	100	140	120

### Temperature Mode

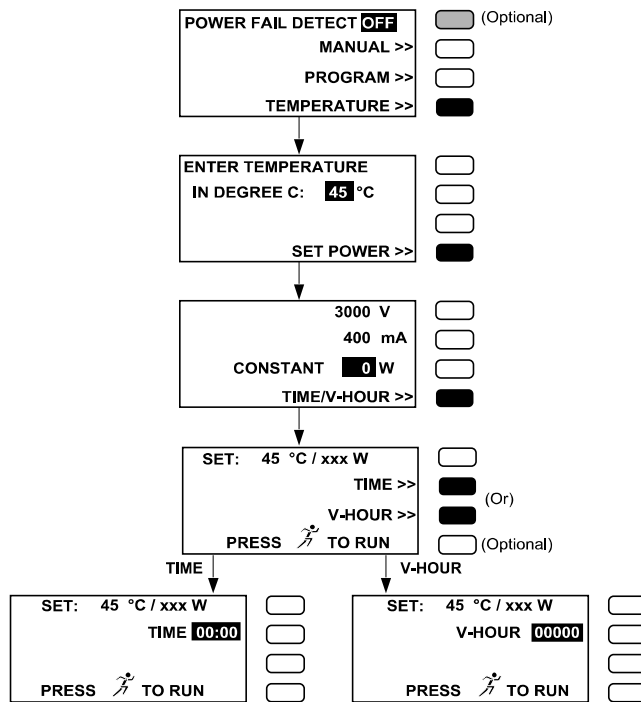


Figure 7. Temperature Mode Flow Chart

## 6.0 MAINTENANCE AND TROUBLESHOOTING

---

### 6.1 MAINTENANCE

PowerPac power supplies require very little maintenance to assure reliable operation. During normal operation, spills and splashes may cause residues to form on the case. Unplug the power supply. Use a damp cloth to wash down the outer case. Avoid wetting the connectors located below the front panel and on the rear of the unit.

### 6.2 TROUBLESHOOTING

If a system or operator error occurs, the appropriate error message will appear on the LCD display. The power does not operate when an error message is displayed.

If a no-load or rapid change in resistance error is inadvertently activated, it is possible to temporarily deactivate it. To deactivate, press the number **6** key and the **STOP** key simultaneously to access the deactivation menu.

Error Message	Solution
<b>RAPID CHANGE IN RESISTANCE SYSTEM WAS SHUT DOWN PRESS CE TO RESET</b>	An unusually rapid change in resistance was detected during an electrophoresis run. This may be due to a leaking cell. <ul style="list-style-type: none"> <li>• Check the cell for leaks.</li> <li>• Reset the power supply by pressing the <b>CE</b> key to return to the last screen. The power supply then is ready to run.</li> </ul>
<b>ARCING WAS DETECTED SYSTEM WAS SHUT DOWN CORRECT THE FAULT PRESS CE TO RESET</b>	System detected electrical arcing (current jumping from one wire to another) during the run. <ul style="list-style-type: none"> <li>• Check the cell for arcing hazards.</li> <li>• Reset the power supply by pressing the <b>CE</b> key to return to the last screen. The power supply then is ready to run.</li> </ul>
<b>GROUND LEAK DETECTED SYSTEM WAS SHUT DOWN CORRECT THE FAULT AND RESTART THE SYSTEM</b>	A ground current leak was detected during the run. <ul style="list-style-type: none"> <li>• Check the cell for improper grounding. If the cell is being cooled with an external chiller, make sure there are no leaks from the coolant circuit into the cell.</li> <li>• Restart the power supply by turning the <b>Power</b> switch off and on.</li> </ul>

<b>Error Message</b>	<b>Solution</b>
<b>NO LOAD DETECTED SYSTEM WAS SHUT DOWN CORRECT THE FAULT PRESS CE TO RESET</b>	<p>The resistance to the load is too high. (It should not be greater than 6 mega-ohms.)</p> <ul style="list-style-type: none"><li>• Check the cell to insure it is properly connected to the power supply.</li><li>• Reset the power supply by pressing the <b>CE</b> key to return to the last screen. The power supply then is ready to run.</li></ul>
<b>POWER FAILURE ! POWER FAIL DETECT OFF RUN WAS TERMINATED PRESS CE TO RESET</b>	<p>The run was terminated due to an AC power failure. Power failure detection was not activated and the run was terminated.</p> <ul style="list-style-type: none"><li>• Reset the power supply by pressing the <b>CE</b> key to return to the last screen. The power supply then is ready to run.</li></ul>
<b>POWER FAILURE ! POWER FAIL DETECT ON RUN WAS COMPLETED PRESS CE TO RESET</b>	<p>The run was terminated due to an AC power failure. Power failure detection was activated and the run was completed after power was restored.</p> <ul style="list-style-type: none"><li>• Reset the power supply by pressing the <b>CE</b> key to return to the last screen. The power supply then is ready to run.</li></ul>
<b>EEPROM IS FAULTY OR MISSING SYSTEM WAS SHUT DOWN CALL BIO-RAD</b>	<p>A software problem has occurred. The power supply cannot operate until the EEPROM is repaired. Call Bio-Rad for assistance.</p>
<b>ROM IS FAULTY OR MISSING SYSTEM WAS SHUT DOWN</b>	<p>A hardware problem has occurred. The power supply cannot operate until the ROM is repaired. Call Bio-Rad for assistance.</p>
<b>OPERATING UNDER VOLTAGE DETECTED CORRECT THE FAULT PRESS CE TO RESET</b>	<p>The voltage in the cell is below the minimum voltage of the power supply.</p> <ul style="list-style-type: none"><li>• Check your experiment's power requirements.</li><li>• Reset the power supply by pressing <b>CE</b>.</li></ul>
<b>VOLT mA NOLOAD ARE NOT CALIBRATED</b>	<p>Calibration has been lost. Call Bio-Rad for assistance.</p>

Error Message	Solution
<p><b><u>PowerPac 1000 only:</u></b>  <b>OPERATING OVER 1000 V, or</b>  <b>OPERATING OVER 500 mA, or</b>  <b>OPERATING OVER 250 W</b>  <b>SYSTEM WAS SHUT DOWN</b>  <b>CORRECT THE FAULT AND</b>  <b>RESTART, OR IF FAULT</b>  <b>PERSISTS, CALL BIO-RAD</b></p>	<p>The voltage, current, or power output has exceeded the power supply's maximum output capability.</p> <ul style="list-style-type: none"> <li>• Check cell for short circuits.</li> <li>• Check buffer concentration.</li> <li>• Restart the power supply by turning the <b>Power</b> switch off and then on.</li> </ul> <p>If the problem persists, there may be a firmware or hardware problem. Call Bio-Rad for assistance.</p>
<p><b><u>PowerPac 3000 only:</u></b>  <b>OPERATING OVER 3000 V, or</b>  <b>OPERATING OVER 400 mA, or</b>  <b>OPERATING OVER 400 W</b>  <b>SYSTEM WAS SHUT DOWN</b>  <b>CORRECT THE FAULT AND</b>  <b>RESTART, OR IF FAULT</b>  <b>PERSISTS, CALL BIO-RAD</b></p>	<p>The voltage, current, or power output has exceeded the power supply's maximum output capability.</p> <ul style="list-style-type: none"> <li>• Check cell for short circuits.</li> <li>• Check buffer concentration.</li> <li>• Restart the power supply by turning the <b>Power</b> switch off and then on.</li> </ul> <p>If the problem persists, there may be a firmware or hardware problem. Call Bio-Rad for assistance.</p>
<p><b>TEMPERATURE PROBE REMOVED</b>  <b>SYSTEM WAS SHUT DOWN</b>  <b>CORRECT THE FAULT</b>  <b>PRESS CE TO RESET</b>  <b>CALL BIO-RAD</b></p>	<p>Temperature probe was removed from the power supply during the run.</p> <ul style="list-style-type: none"> <li>• Reconnect the probe to the power supply.</li> <li>• Reset the power supply by pressing the <b>CE</b> key to return to the last screen. The power supply then is ready to run.</li> </ul> <p>Call Bio-Rad for assistance.</p>
<p><b>ILLEGAL INT DETECTED</b>  <b>SYSTEM WAS SHUT DOWN</b>  <b>CALL BIO-RAD</b></p>	<p>A software problem has occurred. The power supply cannot operate until the illegal interrupt condition is repaired.  Call Bio-Rad for assistance.</p>
<p><b>FOLLOW ERROR DETECTED</b>  <b>SYSTEM WAS SHUT DOWN</b>  <b>CALL BIO-RAD</b></p>	<p>A hardware problem has occurred. The power supply cannot operate until the follow error condition is repaired.  Call Bio-Rad for assistance.</p>
<p><b>DIV ERROR DETECTED</b>  <b>SYSTEM WAS SHUT DOWN</b>  <b>CALL BIO-RAD</b></p>	<p>A software problem has occurred. The power supply cannot operate until the division error condition is repaired.  Call Bio-Rad for assistance.</p>

## APPENDIX A. SPECIFICATIONS

Note: All specifications subject to change without notice.

### Input Rating:

100/120 V model: 90 - 132 VAC, 47 Hz - 63 Hz

220/240 V model: 198 - 264 VAC, 47 Hz - 63 Hz

Input Power Cable: 3-wire; grounded  
I.E.C. power entry module

Output Range: Constant voltage, constant current, constant power.  
(Programmable) Automatic cross-over upon reaching limits.

Voltage: PowerPac 1000: 5 V DC to 1000 V DC; fully adjustable in 1 V steps  
PowerPac 3000: 20 V DC to 3000 V DC; fully adjustable in 1 V steps

Current: PowerPac 1000: 1 mA to 500 mA; fully adjustable in 1 mA steps  
PowerPac 3000: 1 mA to 400 mA; fully adjustable in 1 mA steps

Power: PowerPac 1000: 1 W to 250 W; fully adjustable in 1 W steps  
PowerPac 3000: 1 W to 400 W; fully adjustable in 1 W steps

Output Terminals: 4-pair recessed female banana jacks,  
floating, and wired in parallel

Timer Control: 1 minute to 99 hours and 58 minutes, or  
99,999 volt-hours

No Load Detection: PowerPac 1000: 58  $\mu$ A (or greater than 6 mega-ohm) at greater than 350 V  
PowerPac 3000: 200  $\mu$ A at greater than 350 V

### Performance

Ripple : PowerPac 1000:  $\pm 1\%$  at 1000 V and 250 W  
PowerPac 3000:  $\pm 1\%$  at 3000 V and 400 W

Line Regulation: PowerPac 1000:  $\pm 1\%$  at 1000 V and 225 W from 90 - 132 V AC and 198 - 264 V AC  
PowerPac 3000:  $\pm 1\%$  at 3000 V and 400 W from 90 - 132 V AC and 198 - 264 V AC

Load Regulation: PowerPac 1000:  $\pm 1\%$  at 1000 V for a 50% change in output load  
(200 mA to 400 mA; 400 mA to 200 mA)

Drift: PowerPac 3000:  $\pm 1\%$  at 3000 V for a 50% change in output load  
PowerPac 1000:  $\pm 0.5\%$  after a 30 minute warm-up at 1000 V and 225 W  
PowerPac 3000:  $\pm 0.5\%$  after a 30 minute warm-up at 3000 V and 400 W

Noise: 35 dBA

Readout Stability:	PowerPac 1000	PowerPac 3000
Volts:	±1% at 1000 V full scale	±1% at 3000 V full scale
Current:	±1% at 500 mA full scale	±1% at 400 mA full scale
Power:	±1% at 250 W full scale	±1% at 400 W full scale

Set Point Accuracy:	PowerPac 1000	PowerPac 3000
	±1% at 1000 V full scale	±1% at 3000 V full scale

**Safety Features**

No load detection: LCD alarm display if initial load is greater than 6 million ohm upon start of run. Continual checking during the run if the load is greater than 6 million ohm

Sudden load change detection: Alarm display and power down upon sudden load change.

Ground Leakage: Alarm display if ground leakage is greater than 500µA; power down on failure

Arc detection\*: Alarm display and power down upon arc detection

Overload/short circuit protection: Alarm display and power down upon short circuit detection

PowerPac 1000: 3000 V DC rms isolation from high voltage outputs to earth ground

PowerPac 3000: Internal fusing on both hot and neutral  
4000 V DC rms isolation from high voltage outputs to earth ground

Auto power up after power failure: Alarm display and completion of run if a power failure occurs

Safety Compliance: IEC 1010

EMI Conforms to CE standards for Emissions and Immunity; tested only at 220 V. See Declaration of Conformity for details. TUV EMC certification.

Display: 128 x 64 dot backlit LCD graphics display

Function Modes: Memory for up to 9 programmed methods, each with up to 9 steps  
Constant voltage, constant current, constant power; time and volt-hour control  
Final run conditions (power, volts, and amps) displayed at completion of run

Housing: Spill-resistant design (complies with U.L. 94V0)  
No external heat sinks

Gel Temp. Range: Control range for gel is 0° C to 90° C (±2%)  
(PowerPac 3000)

\*Arc Detection: U.S. patent number 5,280,404

Operating Conditions

Temp.: 0 - 40°C  
Humidity: 0 - 95% relative humidity, non-condensing

Dimensions: 29 (L) x 28 (W) x 11 (H) cm; unit is stackable

Weight: PowerPac 1000: 3.1 kg  
PowerPac 3000: 3.7 kg

## APPENDIX B. WARRANTY AND ORDERING INFORMATION

The PowerPac power supply is warranted for 1 year against defects in materials and workmanship. If any defects should occur during this warranty period, Bio-Rad Laboratories will replace the defective parts without charge. However, the following defects are specifically excluded:

1. Defects caused by improper operation.
2. Repair or modification done by anyone other than Bio-Rad Laboratories or their authorized agent.
3. Use with cables or connectors not specified by Bio-Rad Laboratories for this power supply.
4. Deliberate or accidental misuse.
5. Damage caused by disaster.

For inquiry or request for repair service, contact your local Bio-Rad office.

**Bio-Rad Laboratories**  
2000 Alfred Nobel Drive  
Hercules, California 94547  
Phone: (510) 741-1000  
1-(800) 4-BIORAD  
1-(800) 424-6723  
Fax: (510) 741-1060 or  
1-(800) 879-2289  
Telex: 335-358

**Eastern Regional Office**  
85A Marcus Drive  
Melville, New York 11747  
Phone: (516) 756-2575  
1-(800) 4-BIORAD  
1-(800) 424-6723  
Fax: (516) 756-2594 or  
1-(800) 756-4246

**Australia**  
Bio-Rad Laboratories Pty., Ltd.  
Unit 11  
112-118 Talavera Rd.  
P.O. Box 371  
North Ryde  
New South Wales 2113  
Phone: 02-805-5000  
008-224-354  
Fax: 02-805-1920  
Telex: 79070166

**Austria**  
Bio-Rad Laboratories Ges.m.b.H.  
Auhofstrasse 78D  
A-1130 Wien  
Phone: 1-877 89 01  
Fax: 1-876-56-29

**Belgium**  
Bio-Rad Laboratories S.A.-N.V.  
Begoniastraat 5  
B-9810 Nazareth Eke  
Phone: 09-385-55-11  
Fax: 09-385-65-54

**Canada**  
Bio-Rad Laboratories Ltd.  
5671 McAdam Road  
Mississauga, Ontario L4Z 1N9  
Phone: (905) 712-2771  
1-(800) 268-0213  
Fax: (905) 712-2990

**China**  
Bio-Rad Laboratories  
14, Zhi Chun Road  
Haidian District  
Beijing 100088  
Phone: (01) 2046622  
Fax: (01) 1-2051876

**Denmark**  
Bio-Rad Laboratories  
Symbion Science Park  
Fruebjergvej 3  
DK-2100 Copenhagen  
Phone: 39 17 99 47  
Fax: 39 27 16 98

**Finland**  
Bio-Rad Laboratories  
Business Center Lansikeskus  
Pihatorma 1A  
SF-02240, Espoo  
Phone: 90 804 2200  
Fax: 90 804 1100

**France**  
Bio-Rad S.A.  
94/96 rue Victor Hugo  
B.P. 220  
94203 Ivry Sur Seine Cedex  
Paris  
Phone: 16 1 49 60 68 34  
Fax: 16 1 46 71 24 67

**Germany**  
Bio-Rad Laboratories GmbH  
Heidemannstrasse 164  
D-80939 Munchen  
Postfach 45 01 33  
D-80901 Munchen  
Phone: 089 318 84-0  
Fax: 089 318 84-100

**India**  
Bio-Rad Laboratories  
C-248 Defence Colony  
New Delhi 110 024  
Phone: (91-11) 461 0103  
Fax: (91-11) 461 0765  
(91-11) 462 1863

**Italy**  
Bio-Rad Laboratories S.r.l  
Via Cellini, 18A  
20090 Segrate - Milano  
Phone: 02/21609.1  
Fax: 02/21609.399

**Japan**  
Nippon Bio-Rad Laboratories KK  
7-18, Higashi-Nippori 5-Chome  
Arakawa-ku, Tokyo 116  
Phone: 03-5811-6270  
Fax: 03-5811-6272

**Netherlands**  
Bio-Rad Laboratories B.V.  
Fokkerstraat 10  
3905 KV Veenendaal  
Phone: 0318-540666  
Fax: 0318-542216

**New Zealand**  
Bio-Rad Laboratories Pty., Ltd.  
Unit 15 Poland Court  
21 Poland Road  
P.O. Box 100-051  
North Shore Mail Centre  
Glenfield, Auckland 10  
Phone: 09-443 3099  
0508-805 500  
Fax: 09-443 3097

**Pacific**  
Bio-Rad Pacific Ltd.  
Unit 1111, 11/F., New Kowloon Plaza  
38 Tai Kok Tsui Road  
Tai Kok Tsui, Kowloon, Hong Kong  
Phone: 7893300  
Fax: 7891257

**Singapore**  
Bio-Rad Laboratories (Singapore)  
464 Siglap Road  
#01-02 Flamingo Valley  
Singapore 1545  
Phone: (65) 4432529  
Fax: (65) 4421667

**Spain**  
Bio-Rad Laboratories, S.A.  
Avda. Valdelaparra, 3  
Poligono Industrial de Alcobendas  
E-28100 Alcobendas (Madrid)  
Phone: (91) 661 70 85  
(900) 100 204  
Fax: (91) 661-96-98

**Sweden**  
Bio-Rad Laboratories AB  
Gardsvagen 7D  
Box 1267  
S-171 24 Solna  
Phone: 08-735-83 00  
020 660 660  
Fax: 08 735 54 60

**Switzerland**  
Bio-Rad Laboratories, A.G.  
Kanalstrasse 17  
Postfach  
CH-8152 Glatbrugg  
Phone: 01-809-55 55  
Fax: 01-809-55 00

**United Kingdom**  
Bio-Rad Laboratories, Ltd.  
Bio-Rad House  
Maylands Avenue  
Hemel Hempstead  
Hertfordshire HP2 7TD  
Phone: 01442-232552  
0800-181134  
Fax: 01442-259118

**WARRANTY INFORMATION**

Model: \_\_\_\_\_  
Serial Number: \_\_\_\_\_  
Date of Delivery: \_\_\_\_\_  
Warranty Period: \_\_\_\_\_

**ORDERING INFORMATION**

<b>Catalog Number</b>	<b>Product Description</b>
<b>PowerPac 3000</b>	
165-5056	PowerPac 3000, 100/120 V
165-5057	PowerPac 3000, 200/240 V
165-5058	Temperature Probe
165-5059	PowerPac 3000 with temperature probe, 100/120 V
165-5060	PowerPac 3000, with temperature probe, 220/240 V
<b>PowerPac 1000</b>	
165-5054	PowerPac 1000, 100/120 V
165-5055	PowerPac 1000, 200/240 V
<b>PowerPac 300</b>	
165-5050	PowerPac 300, 100/120 V
165-5051	PowerPac 300, 200/240 V
<b>PowerPac 200</b>	
165-5052	PowerPac 200, 100/120 V
165-5053	PowerPac 200, 200/240 V
<b>PowerPac Accessories</b>	
165-5061	PowerPac Adapter
165-5062	PowerPac Shelf

**BIO-RAD**

**Bio-Rad  
Laboratories**

*Life Science  
Group*

**Web site** [www.bio-rad.com](http://www.bio-rad.com) **Bio-Rad Laboratories Main Office** 2000 Alfred Nobel Drive, Hercules, CA 94547, Ph. (510) 741-1000, Fx. (510) 741-5800  
**Also in:** **Australia** Ph. 02 9914 2800, Fx. 02 9914 2889 **Austria** Ph. (01) 877 89 01, Fx. (01) 876 56 29 **Belgium** Ph. 09-385 55 11, Fx. 09-385 65 54  
**Brazil** Ph. 55 21 507 6191 **Canada** Ph. (905) 712-2771, Fx. (905) 712-2990 **China** Ph. 86-10-8201-1366/68, Fx. 86-10-8201-1367  
**Denmark** Ph. 45 44 52-1000, Fx. 45 4452 1001 **Finland** Ph. 358 (0)9 804 2200, Fx. 358 (0)9 804 1100 **France** Ph. 01 47 95 69 65, Fx. 01 47 41 9133  
**Germany** Ph. 089 318 84-177, Fx. 089 318 84-123 **Hong Kong** Ph. 852-2789-3300, Fx. 852-2789-1257 **India** Ph. (01-124)-6398112/113/114, Fx. (01-124)-6398115  
**Israel** Ph. 03 951 4124, Fx. 03 951 4129 **Italy** Ph. 34 91 590 5200, Fx. 34 91 590 5211 **Japan** Ph. 03-5811-6270, Fx. 03-5811-6272  
**Korea** Ph. 82-2-3473-4460, Fx. 82-2-3472-7003 **Latin America** Ph. 305-894-5950, Fx. 305-894-5960 **Mexico** Ph. 52 5 534 2552 to 54, Fx. 52 5 524 5971  
**The Netherlands** Ph. 0318-540666, Fx. 0318-542216 **New Zealand** Ph. 64-9-4152280, Fx. 64-9-443 3097 **Norway** Ph. 47-23-38-41-30, Fx. 47-23-38-41-39  
**Russia** Ph. 7 095 979 98 00, Fx. 7 095 979 98 56 **Singapore** Ph. 65-2729877, Fx. 65-2734835 **Spain** Ph. 34-91-590-5200, Fx. 34-91-590-5211  
**Sweden** Ph. 46 (0)8-55 51 27 00, Fx. 46 (0)8-55 51 27 80 **Switzerland** Ph. 061-717-9555, Fx. 061-717-9550 **United Kingdom** Ph. 0800-181134, Fx. 01442-259118

Sig 1200

4006038 Rev B

