

**OLYMPUS**<sup>®</sup>

Your Vision, Our Future

RESEARCH SYSTEM MICROSCOPE

**BX51/BX61**

BX2 SERIES

**UIS2**  
World-leading optics

*Everything  
for digital imaging*



# The UIS2 optical system: a new evolutionary advance in fluorescence digital imaging.

The new BX2 series addresses the research demands of the future with Olympus' most advanced optical system to date. UIS2 optics deliver the world's highest standard of fluorescence performance, along with the image quality and clarity needed to progress fast-developing life science research programs. With the increased S/N ratio, high optical transmission factor, and diverse illumination capabilities, the UIS2 optical system provides excellent performance over a newly extended wavelength range between UV and IR. This improvement meets all current demands in fluorescence digital imaging and provides a firm foundation for future developments. As modern research advances to ever higher levels of complexity and sophistication, the need for quality and dependability make the BX2 series today's most convincing solution.



**BX51**  
System Microscope



**BX61**  
Motorized System Microscope

# UIS2

*World-leading optics*



# Higher S/N ratio enables clear capture of weak fluorescence emissions.

## World leading fluorescence performance — a vital key to modern life science research

The ideal in fluorescence observation is to capture high-contrast images with the lowest exposure to excitation light, thus minimizing the chances of cell damage and fluorescence fading. Olympus' UIS2 objectives are precisely designed to obtain bright images from weak fluorescence signals. This improvement in transmission is due to the increased S/N ratio of the UIS2 optics.

## Improved performance of interference membrane-type fluorescence mirror units



S/N ratios are improved by applying new coating technology to the interference membrane of the mirror unit. S/N ratios are also increased by reducing the excitation (BP) and emission (BA) bandwidth by 6nm. The hard coat technique, applied to Olympus fluorescence mirror unit, prolongs the lifetime of the filter.

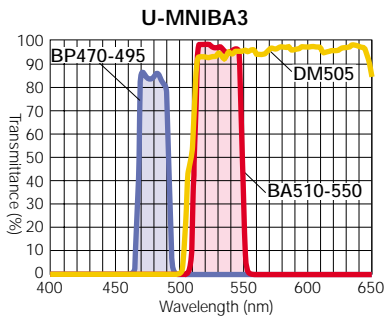

High-performance filters with high transmission factor, optimized to individual fluorochrome characteristics

Mirror unit with stray light reducing function to eliminate noise

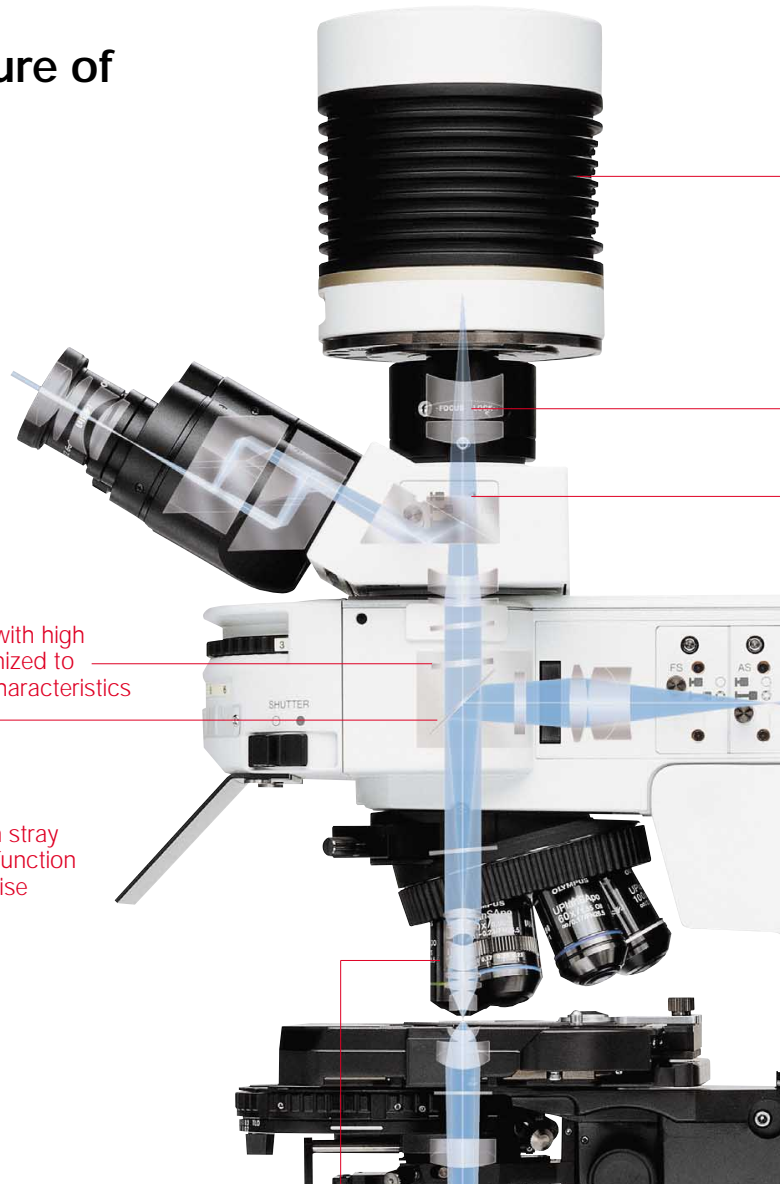

High S/N objectives detect even slight fluorescence emission

## High-quality fluorescence mirror units for fluorescence proteins



The BX2 series HQ type mirror units are ideal for the wavelength characteristics of ECFP/EGFP/EYFP/DsRed. The rapid rise time and high (90-95%) transmission factor efficiently transmit the fluorescence emitted from fluorescence proteins. This allows bright observation images even with weak excitation light, while preventing fluorescence fading and minimizing the chances of cell damage.

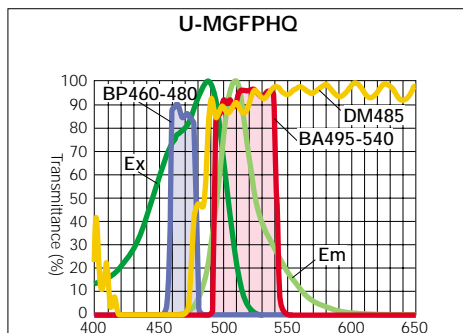

## Stray light reducing function



The slight transmission of stray light when excitation light is reflected in the dichromatic mirror causes a rise in the level of noise. Olympus mirror units absorb more than 99% of this stray light through their light absorber.

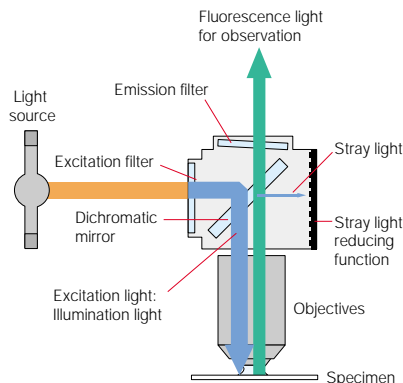

## The best S/N ratio...and the best fluorescence performance



UIS2 objectives' fluorescence S/N is improved by up to 1.5 times that of conventional objectives — by using strictly selected, low autofluorescence glass material, and adopting measures to minimize fluorescence from the reflection prevention coating and cementing material.

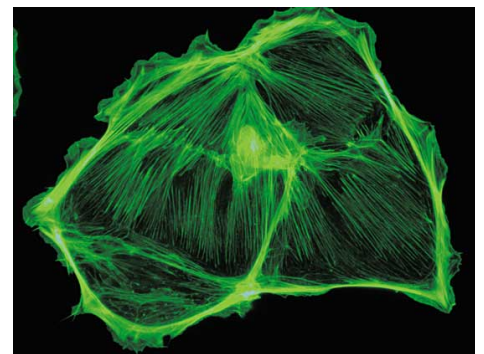

Image captured by the UIS2 objective

High sensitivity cooled CCD camera developed for live cell imaging

Lamp housing with aspherical collector lens providing excellent excitation efficiency

Camera adapter compatible for near infrared region

Trinocular tube compatible for near infrared region



Signal Up

Noise Down

**High sensitivity cooled CCD camera**

The cooled CCD camera DP30BW is designed for fluorescence live cell imaging. It features high sensitivity, high-speed image acquisition and vibration-free operation.

**Excellent trinocular tube performance even in the near infrared region**

The trinocular tube U-TR30NIR improves the transmission factor and compensates for aberrations over a wider wavelength range. A new multi-coating is applied to the trinocular optical surfaces to widen the IR spectral characteristics and allow for observation of newly developed fluorochromes in the near-infrared region.

**Camera adapter suitable for near infrared region**

Users can choose from a variety of low magnification camera adapters with C-mount, all IR-compliant.



**High transmission factor across a wide wavelength spectrum**

The latest UIS2 objectives achieve a flat, high transmission factor over a wide wavelength spectrum, from visible to near infrared — thanks to the incorporation of a newly-developed ultra wide wavelength reflection prevention coating (UW multi-coating). The improvement in transmission factor on the near infrared region is especially notable, and typifies the high performance which makes UIS2 objectives the natural choice in many leading-edge research fields.

**High N.A. objectives for fluorescence imaging**

Signal Up  
Noise Down

The BX2 series features the newly-developed PLAPON60XO objective, offering the world's highest N.A. (1.42) for fluorescence imaging, and the UPLSAPO100XO with high 1.4 N.A. and advanced universal features. In addition to their outstanding fluorescence S/N ratio, they enjoy UV transmission that was previously unachievable with 45mm parfocality. The UPLSAPO100XO objective is especially notable for maintaining its transmission factor up to the 340nm wavelength.

This has improved N.A. while also reducing autofluorescence, two benefits previously considered incompatible. As a result, even weak fluorescence emissions from weak excitation light are efficiently detected, enabling the UIS2 system to provide the best fluorescence imaging of live cells.

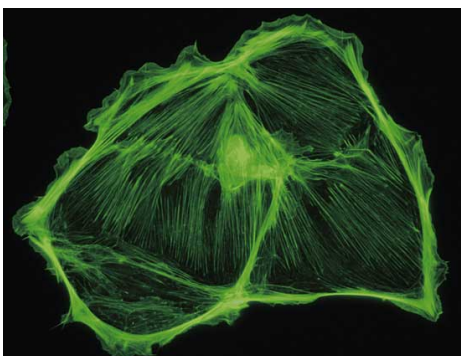
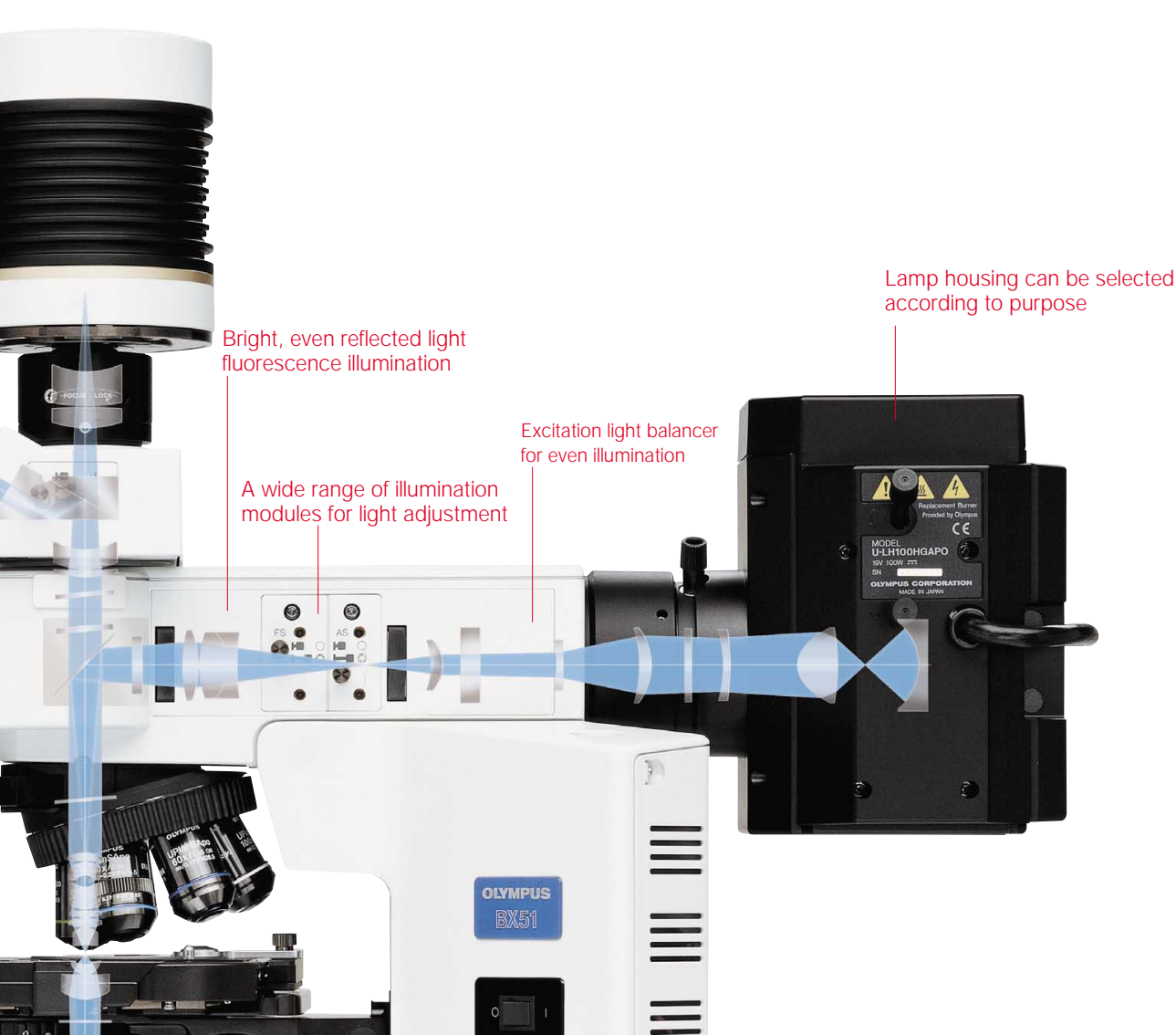

Image captured by a conventional objective



**Up to near infrared compensation for chromatic aberration**

UPLSAPO series objectives' Super Achromat performance compensates for all chromatic aberrations, from visible to up to 1000nm wavelength light. Clear images without color shift are provided even in multi color observations that use fluorochromes whose excitation light wavelength is spread over a wide range. Imaging all the way from UV to IR can be performed with a single objective.



### High-rigidity reflected light illuminator

Two types of reflected light illuminator are provided: the multi-purpose BX-RFA, suitable for a wide range of different research projects, and the economical BX-URA2. Up to 6 mirror units can be attached in the cassette, which is especially useful when observing multi-stained specimens. A click weight adjustment function is provided for filter exchange, and a click release function that eliminates vibration.



### Lamphouses according to your purpose

Two 100W mercury lamphouses (U-LH100HG and U-LH100HGAP0) are available, the latter with color correction extending to UV wavelengths. The U-LH75XEAP0 is available for 75W xenon lamps, also with correction extending to the UV. The U-LH50MH is available for 50W metal halide lamps, increasingly used for routine observation and featuring a long lifetime with no centration required.



### Double lamp housing adapter U-DULHA for exchange between two light sources

When two different light sources are attached at the same time, this adapter unit enables easy exchange between them according to the user's purpose. (Optical path: 100/0, 0/100, F.N.11)



### Luminous mirror unit indicator for easy confirmation in dark room

Bright, easy-to-see self-illuminated labels are used to denote fluorescence filter sets, easily visible in a dark room. Three filter positions are displayed simultaneously making selection of the next filter easy and intuitive.



### Bright, consistent illumination

Twice the brightness provided by conventional models can be obtained with the 10X ~ 20X objectives, or 2-3 times the brightness when light is narrowed to F.N. 12. This enables efficient observations at lower magnifications.

### Convenient 6-position filter sliders U-RSL6/U-RSL6EM

Setting the excitation and emission filters on this sextuple filter slider enables synchronous and continuous exchange between positions. With ND filters attached, illumination can be adjusted in 6 steps.



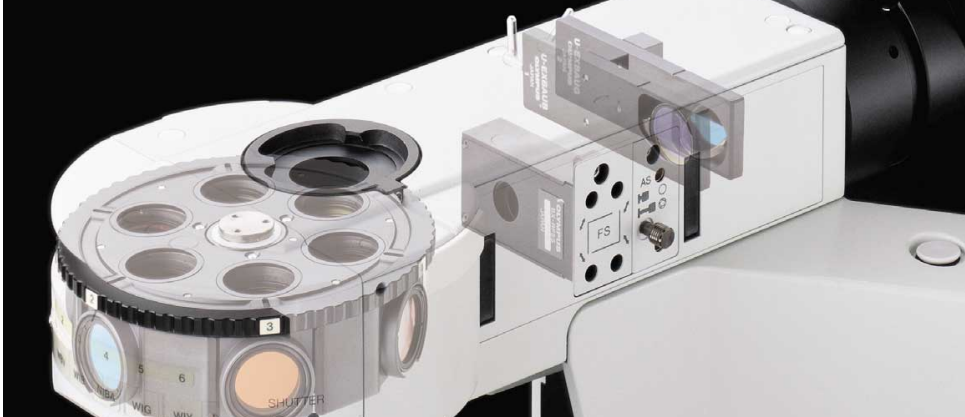

**Pinhole field stop module/BX-RFSPOT**

This slider makes it possible to use the light source as a spotlight, illuminating tiny individual areas on the fluorescence specimen — an especially valuable feature in experimental work. The slider is attached to the BX-RFA fluorescence illuminator in the field stop position.

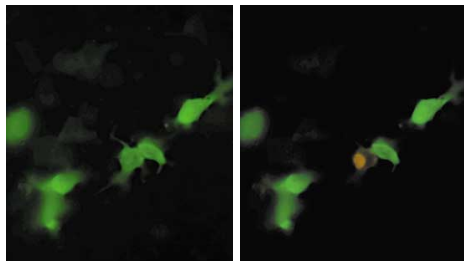

**Rectangular field stop for digital imaging/U-RFSS**

The rectangular field stop can be set to the exact size of the imaging sensor to avoid fading outside of the imaging area and damaging sensitive tissue.



Unnecessary exposure area caused by a round field stop

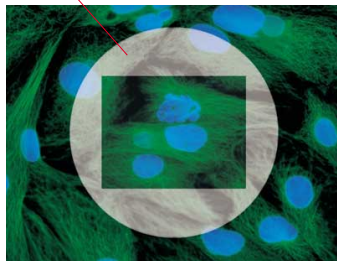

**Fluorescence excitation balancers/ U-EXBABG, U-EXBAUB, U-EXBAUG**

When observing double and triple stained specimens, both observation and photography can be conducted by arranging or altering the fluorescence brightness while freely changing the excitation light for each stained color. An excitation balancer is attached in the parallel light path, so there is no unevenness in the visual field.

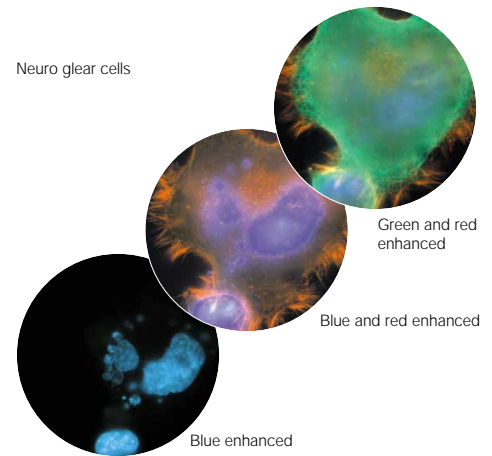

**Confocal laser scanning biological microscope/FV1000**

The FluoView/FV1000 is a next-generation imaging system designed for high-resolution, confocal observation of both fixed and living cells. The FV1000 offers advances in confocal system performance while providing the speed and sensitivity required for live cell imaging with minimal risk of damage to living specimens. In addition, the FV1000 offers a revolutionary synchronized laser scanning system called the SIM Scanner. While one laser stimulates, the second laser simultaneously provides high-resolution imaging. This coordination of laser stimulation and imaging makes the FV1000 an ideal choice for FRAP, FLIP and photoactivation.



FV1000



BX51-FL

# Varied illumination and advanced optics deliver top quality digital photo images.

## Excellent color reproduction from daylight illumination

Since Olympus microscopes apply ideal color temperature at natural daylight (5500K) throughout the light source, the objectives and the CCD camera, the camera captures color information accurately and provides faithful reproduction on the display.

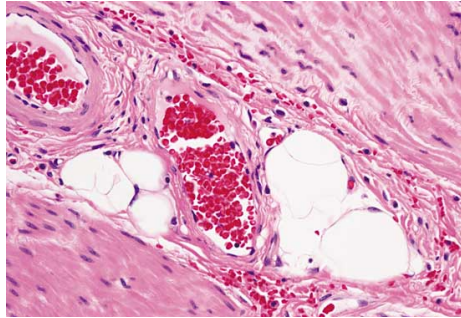

## Even illumination to the edge of the visual field

Using an original transmitted light diffusion simulation technology, Olympus developed a diffusion optical device which provides bright, even illumination from low to high magnifications.

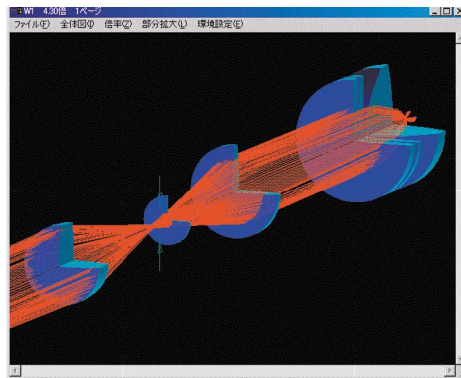

## UIS2 optics provide high transmission factors for clear, flat images

In the UIS2 optical system, improved transmission factors and compensation for chromatic aberration over a wide wavelength spectrum are not only characteristics of the objectives, but also of image forming components such as the trinocular tube and video camera adapter. As a result, images at all magnification levels are flat, sharp, clear and free from color shift.

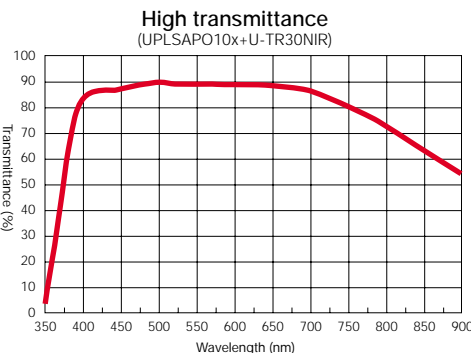

## Optimal trinocular tube for digital imaging

The high sensitivity of a digital camera allows photos to be taken in about half the light required by a conventional film camera. To optimize digital photography during an observation, Olympus' new trinocular tube U-TR30NIR provides a choice of three light path exchange levels: 100% for binocular, 100% for camera, or 50% each for binocular and camera. This enables photo images equal in brightness to the observation image to be captured on the CCD surface.



## High sensitivity cooled CCD camera/ DP30BW

High sensitivity, vibration-free cooled CCD camera for fast 15 frames/sec. live display.

Using its Peltier-cooled system, the DP30BW offers quiet, vibration-free



## Microscope digital camera/ DP70

High-resolution digital images equivalent to 12.5 million pixels captured in approx. 3 seconds — from brightfield to fluorescence.

Thanks to its high-speed hardware, the DP70 can capture high-resolution images equivalent to 1.25 million pixels in around 3 seconds. The camera's high sensitivity and



operation. Combined with the built-in shutter and highly effective synchronized background subtract function (dark current is electronically reduced on the PCI board), these features enable high-quality recording of even weak fluorescence images.



Configuration example

low noise (equivalent to the level of ISO 1600) ensure clear fluorescence imaging, while the resolution quality allows precise representation of particular specimen areas.

By shifting the pixels of the 1.45 million pixel 2/3 inch CCD (one pixel = 6.45µm), it is possible to record still images equivalent to the maximum image recording size (4080X3072) or effective image size of 12.5 million pixels.



Configuration example

### Imaging software (for DP70, DP30BW) / DP-BSW

DP-BSW is a user-friendly image capturing software package with a simple, easy-to-use GUI (Graphical User Interface) and high speed live display. It can be used to control different types of motorized units, and to perform both still time-lapse image and live image movie recording.

- Intuitive, easy-to-use GUI. Tool bar items can be user-customized and menu icons restricted to frequently used functions.
- Comments with arrow, time and scale can be stored with individual images.

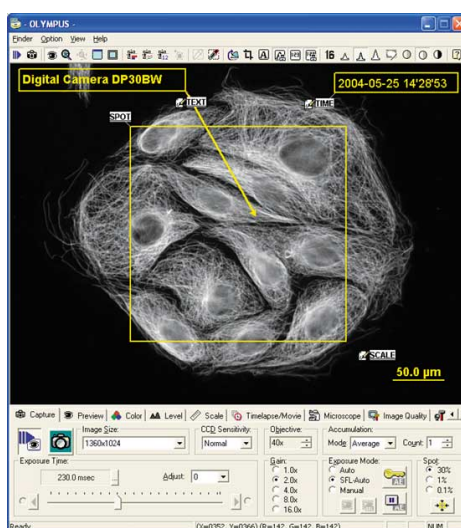

- Focus indicator function shows overall image focusing status; line profile function enables detailed focusing on selected areas.
- Three different metering areas (30%, 1% and 0.1%) can be selected, and moved over the specimen as required, allowing highly precise exposures. A spot centering button is provided to locate and highlight the center of the image.

- In simple time-lapse image mode, the shutter can be opened/closed before/after the exposure by synchronous use of a UNIBLITZ shutter (made by Vincent Associates) or Olympus shutters for the BX61.

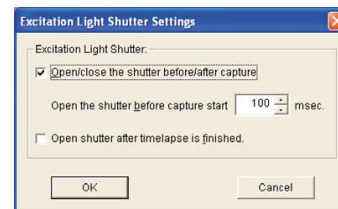

- Recorded images can be stored in AVI or MPEG-1 formats, for intermittent shooting of still images or "movie" recording of live images.

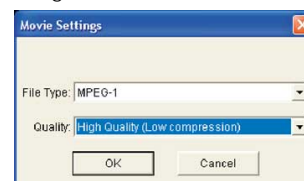

- Separate color/grayscale images captured for each excitation wavelength in a multi stained specimen can be combined in layers to create a single composite image.

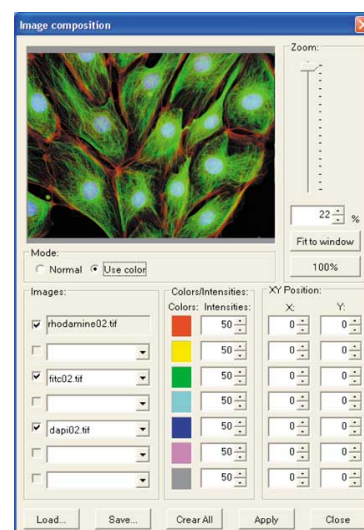
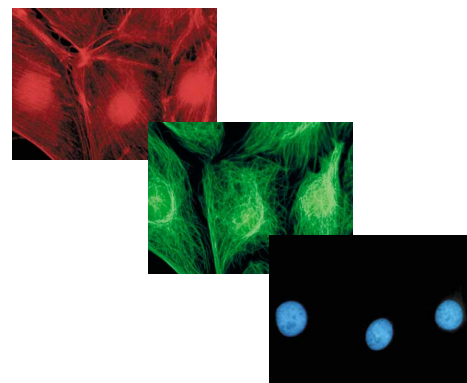

# The advanced UIS2 system delivers high performance over a wider wavelength spectrum.

## UIS2 optics inherit high expandability

As heir to Olympus' infinity-corrected optical system, in which the tube lens is built into the microscope body, UIS2 optics display no image deterioration even when many different optical components or equipment are inserted in the parallel light path. This inherent expandability gives users ample freedom to construct the system in a way that meets their specific requirements.

## UW (Ultra wideband) multi-coating reduces autofluorescence and improves S/N ratio

By using carefully selected raw materials for glass, and applying advanced UW multi-coating technology, Olympus has reduced objective autofluorescence and significantly improved the S/N ratio.

## Flat, high transmission factor over wide wavelength range from UV to IR

UW multi-coating also supports a flat, high transmission factor over a wide wavelength range, ensuring high performance in research tasks using different types of fluorochromes.

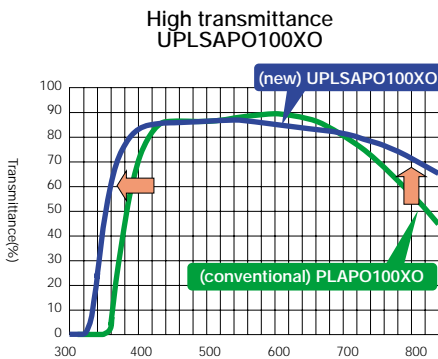

## Thorough chromatic aberration compensation up to near infrared region

UPLSAPO objectives completely eliminate chromatic aberration up to the near infrared region, matching the ability of Super Apochromat objectives to provide clear images without overlapping colors or color shift. As a result, a single objective can perform imaging from UV to IR wavelengths.

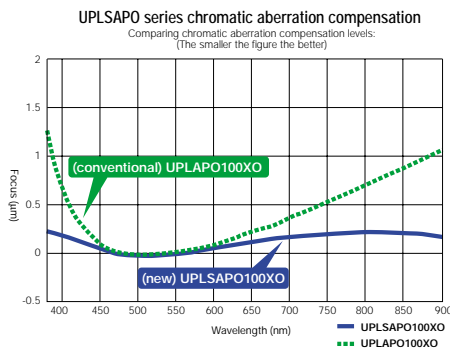

### ■ UPLSAPO series

Thanks to the application of Olympus' original UW multi-coating, these Super Apochromat objectives fully compensate for both spherical and chromatic aberrations from the UV to the near infrared region. Their sensitivity to fluorescence emissions ensures the acquisition of sharp, clear images, without color shift, even in brightfield and Nomarski DIC observations. For quality and performance, they offer an unbeatable solution to every kind of digital imaging need.



### ■ PLAPON series

These Apochromat objectives feature UW multi-coating to provide flat images from high transmission factors up to the near infrared region of the spectrum. They are also fully suitable for low (1.25X and 2X) magnification observations. The PLAPON60XO objective is the first in the world to achieve N.A. 1.42 for fluorescence imaging.



**UIS2 objectives \***

Objective	N.A.	W.D. (mm)	F.N.	Cover glass thickness (mm)	Immer-sion	Spring	Cor-rec-tion ring	Iris dia-phragm
UPLSAPO 4X	0.16	13	26.5	—				
UPLSAPO 10X	0.40	3.1	26.5	0.17				
UPLSAPO 20X	0.75	0.6	26.5	0.17		○		
UPLSAPO 40X	0.90	0.18	26.5	0.11-0.23		○	○	
UPLSAPO 60XW	1.20	0.28	26.5	0.15-0.2	Water	○	○	
UPLSAPO 60XO	1.35	0.15	26.5	0.17	Oil	○		
UPLSAPO 100XO	1.40	0.13	26.5	0.17	Oil	○		
PLAPON 1.25X	0.04	5	26.5	—				
PLAPON 2X	0.08	6.2	26.5	—				
PLAPON 60XO	1.42	0.15	26.5	0.17	Oil	○		
PLAPON 60XOTIRFM	1.45	0.1	26.5	0.13-0.19	Oil	○	○	
UPLFLN 4X	0.13	17	26.5	—				
UPLFLN 10X	0.30	10	26.5	—				
UPLFLN 20X	0.50	2.1	26.5	0.17		○		
UPLFLN 40X	0.75	0.51	26.5	0.17		○		
UPLFLN 40XO	1.30	0.2	26.5	0.17	Oil	○		
UPLFLN 60X	0.90	0.2	26.5	0.11-0.23		○	○	
UPLFLN 60XOI	1.25-0.65	0.12	26.5	0.17	Oil	○		○
UPLFLN 100XO	1.30	0.2	26.5	0.17	Oil	○		
UPLFLN 100XOI	1.3-0.6	0.2	26.5	0.17	Oil	○		○
UPLFLN 10XPH	0.30	10	26.5	—				
UPLFLN 20XPH	0.50	2.1	26.5	0.17		○		
UPLFLN 40XPH	0.75	0.51	26.5	0.17		○		
UPLFLN 60XOIPH	1.25-0.65	0.2	26.5	0.17	Oil	○		○
UPLFLN 100XOPH	1.30	0.2	26.5	0.17	Oil	○		
PLN 2X	0.06	5.8	22	—				
PLN 4X	0.10	18.5	22	—				
PLN 10X	0.25	10.6	22	—				
PLN 20X	0.40	1.2	22	0.17		○		
PLN 40X	0.65	0.6	22	0.17		○		
PLN 50XOI	0.90-0.50	0.2	22	—	Oil	○		○
PLN 100XO	1.25	0.15	22	—	Oil	○		

Objective	N.A.	W.D. (mm)	F.N.	Cover glass thickness (mm)	Immer-sion	Spring	Cor-rec-tion ring	Iris dia-phragm
PLN 10XPH	0.25	10.6	22	—				
PLN 20XPH	0.40	1.2	22	0.17				
PLN 40XPH	0.65	0.6	22	0.17		○		
PLN 100XOPH	1.25	0.15	22	—	Oil	○		
PLN 4XP	0.10	18.5	22	—				
ACHN 10XP	0.25	6	22	—				
ACHN 20XP	0.40	3	22	0.17				
ACHN 40XP	0.65	0.45	22	0.17		○		
ACHN 100XOP	1.25	0.13	22	—	Oil	○		

\* All UIS2 objectives and WHN eyepieces: lead-free eco-glass

**UIS objectives**

Objective	N.A.	W.D. (mm)	F.N.	Cover glass thickness (mm)	Immer-sion	Spring	Cor-rec-tion ring	Iris dia-phragm
UPLAPO 10XO3	0.40	0.24	26.5	0.17	Oil	○		
UPLAPO 20XO3	0.80	0.19	26.5	—	Oil	○		
UPLAPO 40XO3	0.50-1.00	0.12	26.5	—	Oil	○		○
PLAPO 40X	0.95	0.13	26.5	0.11-0.23		○	○	
UPLFL 4XP	0.13	13	26.5	—				
UPLFL 10XP	0.30	3.1	26.5	—				
UPLFL 20XP	0.50	1.6	26.5	0.17		○		
UPLFL 40XP	0.75	0.51	26.5	0.17		○		
UPLFL 100XO3P	1.30	0.1	26.5	0.17	Oil	○		
PLFL 100X	0.95	0.2	26.5	0.14-0.2		○	○	

**UPLFLN (UPLFLN-PH) series**

These plan objectives also provide flat images from high transmission factors up to the near infrared region of the spectrum through the employment of UW multi-coating. With their high S/N ratio, excellent resolution and high contrast imaging, they are especially effective in brightfield and Nomarski DIC observations. The UPLFLN-PH series is optimized for phase contrast observation.



**PLN(PLN-PH) series**

Ideal for a range of clinical and research applications, these high quality objectives feature excellent flatness up to F.N. 22 in transmitted brightfield (phase contrast) observation. The PLN-PH series is specifically designed for phase contrast work.



# New DIC observation system optimizes the specimen image at wider magnifications.

## Optimum shearing volume according to the specimen

Three types of prisms with different shearing volumes are provided to define contrast and resolution. When using the minimum shearing volume prism (HR), which emphasizes resolution, images of thick specimens can be observed without glare.

## New DIC system allows wider selection

More DIC-compatible objectives are available, and users can select the most suitable shearing volume for a given specimen from among 10X to 100X objectives. In addition, combination with other observation methods and components is simpler and more convenient.

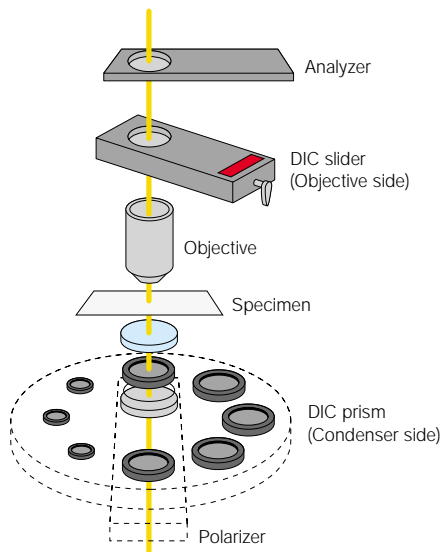

### • High contrast for thin specimens U-DICTHC

High contrast can be obtained even in high magnification observations of thin specimens, such as culture cells.



PK2 cell

### • High resolution with less glare U-DICTHR

This unit enables observations with high resolution but less glare even for thick specimens used in developmental and genetic research, such as finely-structured diatoms, embryos, zebrafish and *C. elegans*.



*C. elegans*

### • High all-round performance U-DICT, U-DICTS

Suitable for observing a wide range of general specimens, such as tissue.

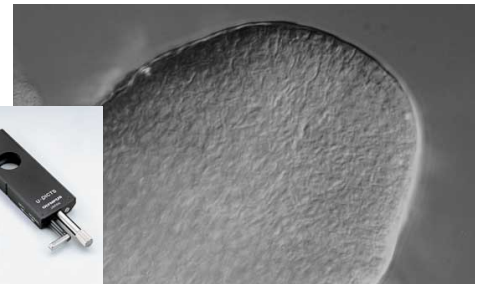

A shoot apical meristem of rice

	For high contrast	For high resolution	General	
Specimen	Thin	Thick	—	
DIC slider (objective side)	U-DICTHC	U-DICTHR	U-DICT*1	U-DICTS*1

\*1 Choose upon objective magnification

## Universal condenser U-UCD8

This condenser, with built-in polarizer, allows simultaneous attachment of up to 8 optical components, freely combined or easily exchanged.



## Septuple revolving nosepiece for DIC/simple POL/ U-D7RE

Equipped with a DIC slider, the U-D7RE septuple revolving nosepiece allows simultaneous attachment of 7 objectives ranging from low to high magnifications. It is especially suitable for combined DIC and fluorescence observations.



Clear, high-contrast imaging from low to high magnifications.

Brightfield

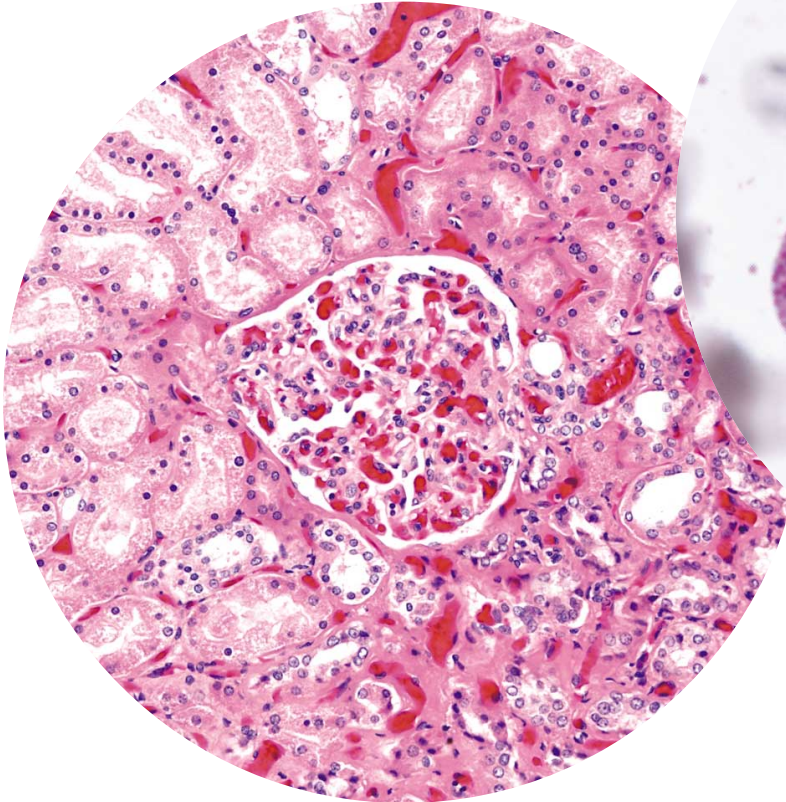

Kidney

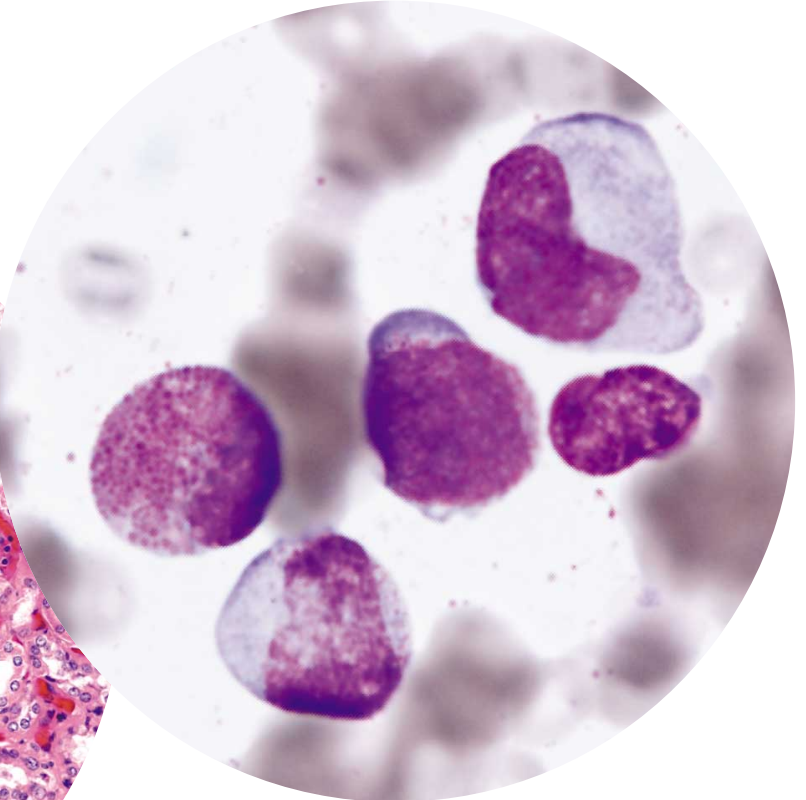

Bone marrow

### Task-specific brightfield condenser options

According to their purpose, users can choose from the U-SC3, a swing-out condenser suitable for observations from 1.25X-100X; the U-AC2, a highly cost-efficient Abbe-type model; the U-AAC, whose apochromat design comprehensively eliminates chromatic aberration; and the U-ULC-2, a special condenser for ultra low magnifications.

\* Select the U-ULC2 condenser for taking an image using a 1.25X objective.



### Clear, high-contrast observation of stained specimens

Image contrast is significantly enhanced by combining UIS2 objectives with the UIS2 eyepiece WHN, which features multi-coating on all its surfaces. This makes the image background look whiter, so that the stained area of the specimen stands out more clearly.



# Ideal phase contrast observation with excellent image clarity.

Phase Contrast

## High-contrast observation of internal structure of live cells/fungus

• UPLFLN-PH series objectives have high transmission factors, producing well-balanced images with high contrast even at low magnifications. They are suitable for simultaneous fluorescence, brightfield and darkfield observations.



Phase contrast accessories

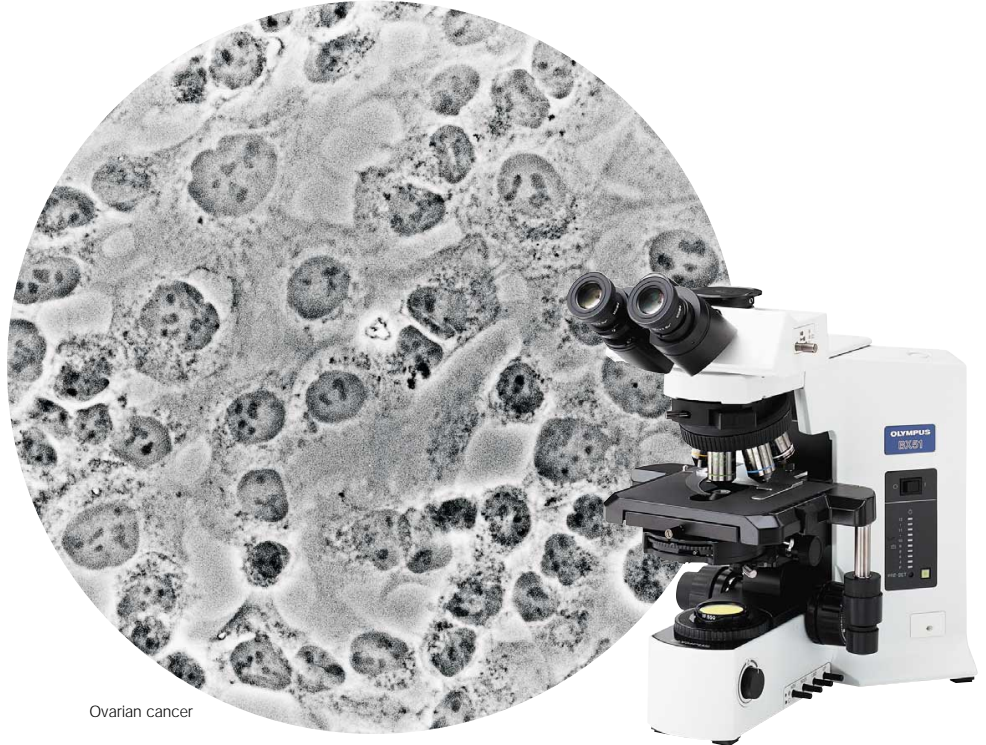

Ovarian cancer

# High-quality darkfield effect at all magnifications.

Darkfield

## Observing algae in water, or muscle tissue

Two darkfield condensers are provided: dry darkfield condenser U-DCD, for magnifications from 10X to 40X (up to N.A.0.92); and oil immersion darkfield condenser U-DCW, for magnifications from 20X to 100X (up to N.A. 1.2).

\* Please consult your nearest Olympus dealer for applicable objectives.



U-DCD

U-DCW

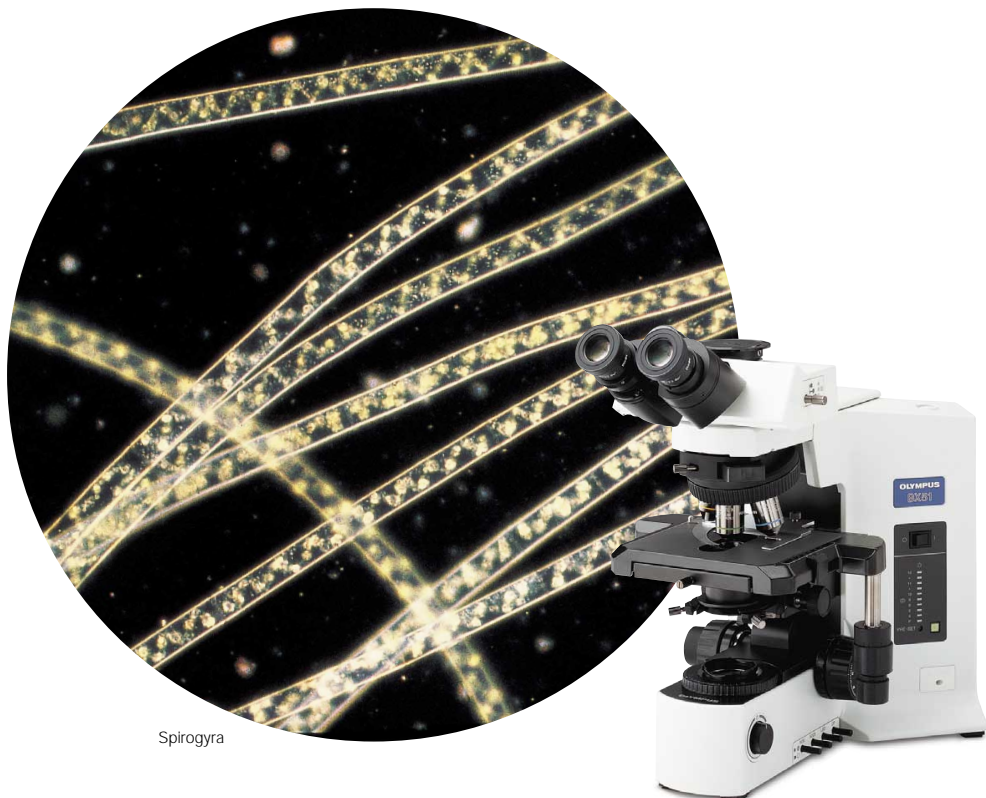

Spirogyra

# Polarizing observation for wide-area retardation measurement.



Vitamin C

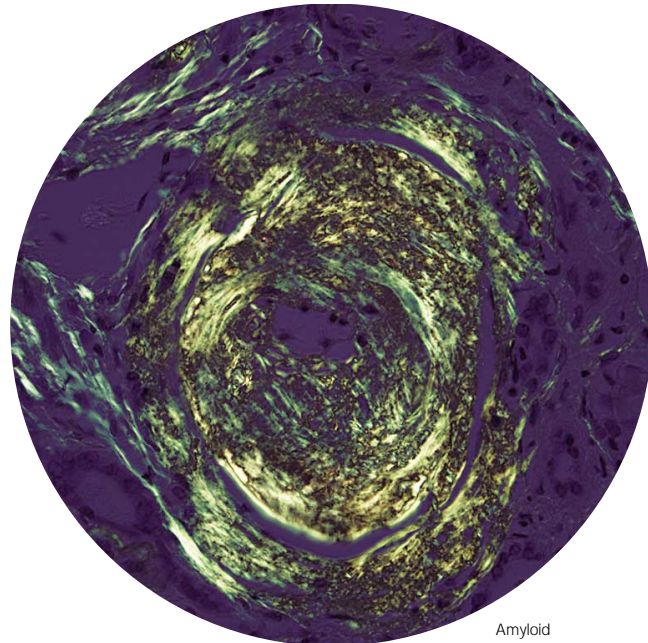

Amyloid

■ With the U-CPA conoscopic observation attachment, the changeover between orthoscopic and conoscopic observation methods is simple and quick — just slide the Bertrand lens control knob in or out.

■ UPLFL-P series objectives, designed for observation under polarizing light, can be used with the revolving nosepiece U-P4RE, which provides a centering function, and the special polarizing light condenser U-POC-2. Also available as an option is the sextuple revolving nosepiece U-P6RE, which allows perfect alignment of the light path among 3 objectives.

■ The circular rotatable stage has two centering knobs and allows smooth sample rotation.

By setting a click stop every 45 degrees, it enables accurate observation and measurement.

■ Mounting an attachable cross-movement mechanical stage (U-FMP) onto the circular

rotatable stage makes for improved observation efficiency. Interference between the mechanical stage and the objectives is eliminated, so that images of superb quality can be effortlessly observed at all objective magnification.



U-FMP

### Measuring range of compensators

Compensator	Measurement range	Applications
Thick Berek (U-CTB)	0-11,000nm (20λ)	Measurement of high retardation level ( $R^* > 3λ$ ), (crystals, macromolecules, fiber, etc.)
Berek (U-CBE)	0-1,640nm (3λ)	Measurement of retardation level (crystals, macromolecules, living organisms, etc.)
Senarmont compensator (U-CSE)	0-546nm (1λ)	Measurement of retardation level (crystals, living organisms, etc.) Enhancement of image contrast (living organisms, etc.)
Brace-Koehler compensator 1/10λ (U-CBR1)	0-55nm (1/10λ)	Measurement of low retardation level (living organisms, etc.)
Brace-Koehler compensator 1/30λ (U-CBE2)	0-20nm (1/30λ)	Enhancement of image contrast (living organisms, etc.)
Quartz wedge (U-CWE2)	500-2,200nm (4λ)	Approximate measurement of retardation level (crystal, macromolecules, etc.)

\*R= retardation level

For more accurate measurement, it is recommended that compensators (except U-CWE2) be used together with the interference filter 45-IF546.



① U-TP530 ② U-TP137 ③ U-TAD ④ U-CBR1 ⑤ U-CBR2  
⑥ U-CWE2 ⑦ U-CSE ⑧ U-CBE ⑨ U-CTB



BX51 Orthoscopic configuration

BX51 Conoscopic/  
Orthoscopic configuration

# New advances in ergonomics secure improved observation efficiency.

## Rackless stage design

BX2 series microscopes feature a wire-driven stage from which the X-axis guide does not protrude. This design provides a rigid and precise X-Y translation, and avoids damage caused by stray glass chips. The X-Y movement weight is freely adjustable. The stage surface has a ceramic coating which provides excellent wear resistance and ensures consistently smooth specimen movement.



## Grooved oil stage

For operators who frequently use high magnification oil immersion objectives, Olympus offers a special stage with a groove for oil run-off, to prevent glass slides from sticking to the surface.

## Smooth, light rubber knob movement

A rubber cap allowing light and accurate one-finger operation is available as option.



## DC power source with no flicker

The microscope body's power source is direct current, which delivers bright observation images without flicker.

## Metal construction for maximum rigidity

The microscope bodies are made from aluminum alloy to ensure the high rigidity needed for consistent performance and long-term durability.



## Swing-out U-SC3 condenser allows observation over wide area

The swing-out U-SC3 condenser is suitable for all observations from 1.25X to 100X. No special condenser is required for work at ultra low magnifications.



## Up to 4 filters can be mounted

Space is provided for an optional fourth filter. This allows any filter to be inserted freely, and the built-in frost filter to be changed. Changing to direct light observation is a one touch operation.

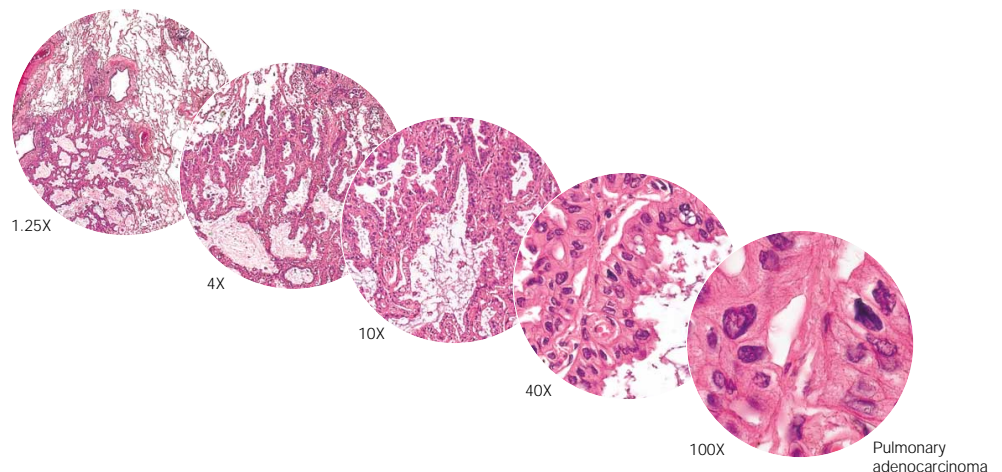

# High-efficiency motorized system meets more sophisticated research demands.

## Motorized Image Capture Microscope

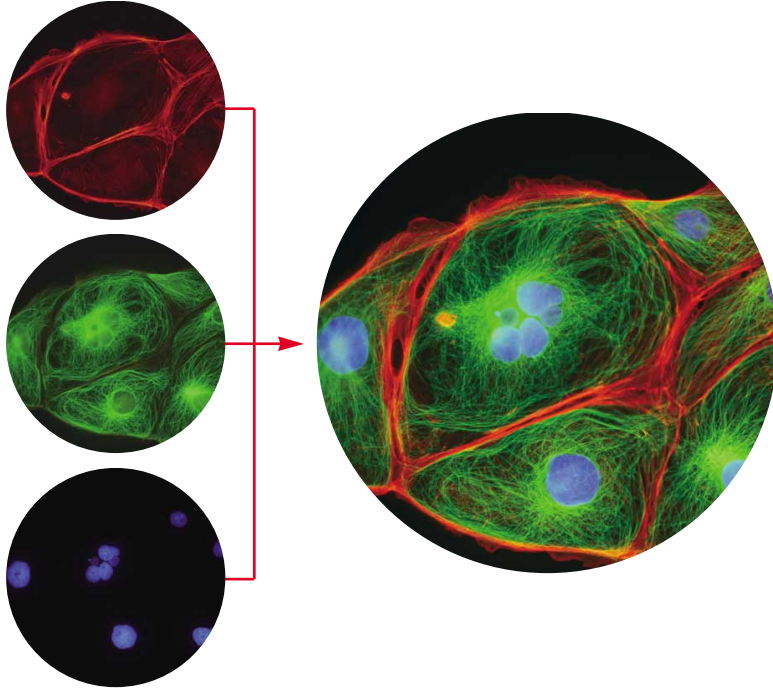

### Auto focus unit / U-AFP1

Maintains steady auto focusing with 1.25X to 100X objectives. Suitable for all observation methods except phase contrast. A host personal computer and BX-UCB are required.



### Filter wheels / U-FWR, U-FWO and U-FWT

Motorized exchange of 6 filters. 3 kinds of filters can be attached simultaneously: U-FWR (ø32, 25) for excitation, U-FWO (ø32, 25) for emission and U-FWT (ø32) for transmitted light.



### Reflected light illuminator/BX-RFAA

This motorized turret can load up to 6 fluorescence mirror units. Also, equipped with motorized shutter.



### Motorized revolving nosepiece/ U-D6REM

Motorized sextuple revolving nosepiece with slider slot for Nomarski DIC.



### Motorized universal condenser/ U-UCD8A

8 position universal condenser. Different combinations of designated optical components allow for various kinds of transmitted light observation. Automatic control of optical component exchange, top lens swing out and aperture iris diaphragm.



### Light adjustment buttons



### Stage adjustment buttons



- **Lamp preset and lamp on/off button**  
Mounted on the front left side of the microscope frame.
- **Fine/coarse and stage escape button**  
Mounted on the left side of the microscope frame.
- **Hand switch/U-HSTR2**  
Hand set used to control the microscope while conducting visual observations.
- **Control box/BX-UCB**  
Motorized modules attached to the microscope are controlled via this control box, which is linked to the computer via an RS232C connector.



BX-UCB



U-HSTR2

# Meticulously selected accessories further enhance new BX2 functions.

## EYEPIECES/PHOTO EYEPIECES



### Eyepieces/WHN, WH, SWH

Eyepieces maintain image flatness even when a reflected light illuminator or other intermediate tube is attached. The two available types are F.N. 22 and F.N. 26.5.



### Photo eyepieces/PE2X, 2.5X, 3.3X, 4X, 5X

These eyepieces accurately reproduce the high quality, high contrast image forming performance of UIS2 objectives.

### Eyepiece specifications

Item	Name	F.N.	Diopter	Micrometer (ømm)
Widefield	WHN10X	22		24
	WHN10X-H	22	-8 — +5	24
	WH15X	14		24
	CROSSWHN10X	22	-8 — +5	
Super widefield	SWH10X-H	26.5	-8 — +2	—
	MICROSSWH10X	26.5	-8 — +2	
	CROSSSWH10X	26.5	-8 — +2	
	PSWH10X	26.5	-8 — +2	
Finder eyepiece	35WHN10X	22	-8 — +5	
	35SWH10X	26.5	-8 — +2	
	PSWH10X	26.5	-8 — +2	

\* Users who want the SWH10X micrometer: please have your eyepiece adapted by the manufacturer.

## OBSERVATION TUBES/EYEPOINT ADJUSTER

A wide range of observation tubes is available for the BX2 series, including wide field binocular and trinocular types, various tilting tubes, and tubes for observation of upright images in which the specimen and the observed image move in the same direction.



- ① Super widefield erect image trinocular tube/U-SWETR
- ② Super widefield trinocular tube/U-SWTR-3
- ③ Trinocular tube/U-TR30-2
- ④ Trinocular tube/U-TR30NIR
- ⑤ Binocular tube/U-BI30-2
- ⑥ Tilting binocular tube/U-TBI-3
- ⑦ Ergonomical binocular tube/U-ETBI
- ⑧ Ergonomical binocular tube/U-TTBI
- ⑨ Single port tube/U-SPT
- ⑩ Eyepoint adjuster/U-EPA2

## CONDENSERS

Universal condensers, ultra low magnification condensers and Abbe type condensers are available to meet all observation needs.



8 position universal condenser/U-UCD8  
Top lenses/U-TLD, U-TLO



Brightfield condensers



Darkfield condensers



Phase/darkfield condenser/U-PCD2



Polarizing condenser U-POC-2

## STAGES

The U-SHG and U-SHGT rubber grip can be attached to the standard stage handle. Different specimen holders are available for use with one glass slide or two, making it easy to switch specimens with just one hand. A simple plain stage is available with optional stage clips. Rotatable stages are available with the option of simple stage clips or attachable mechanical stage mechanisms. A special grooved stage is available, designed to disperse immersion oil, preventing the glass slide from sticking to the stage surface. Users can choose according to purpose.



Mechanical stage with left-hand control/U-SVLB-4  
Specimen holder/U-HRD-4  
Rubber grip/U-SHG



Mechanical stage with right-hand control/U-SVRB-4  
Specimen holder/U-HLD-4  
Rubber grip/U-SHG



Oil rectangular stage with right-hand control/U-SVRO  
Oil rectangular stage with left-hand control/U-SVLO  
Specimen holder/U-HLD-4, Rubber grip/U-SHG



Plain stage/U-SP

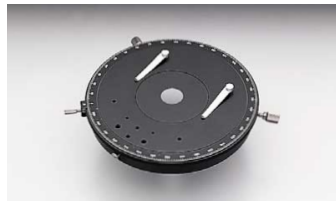

Rotatable stage/U-SRG2



Precision rotatable stage/U-SRP,  
Mechanical stage/U-FMP

## REVOLVING NOSEPIECES



Septuple revolving nosepiece for DIC/simple POL/  
U-D7RE

Septuple revolving nosepiece with slider slot for DIC/POL. Use of thick specimen holder may damage some objectives.



Centerable sextuple revolving nosepiece/  
U-P6RE

Sextuple centerable revolving nosepiece allows centering of three objectives. Use of thick specimen holder may damage some objectives.

## GROUP OBSERVATION SYSTEMS

### Multi observation bodies/BX2-DO, BX2-SDO, BX2-MDO-5, BX2-MDO-10

Olympus discussion systems are invaluable for research studies, lab training, and education. Multi-view configurations are available to accommodate between 2 and 10 participants. The pointer is powered by LED, so there is no need for concern about sudden lamp failure.

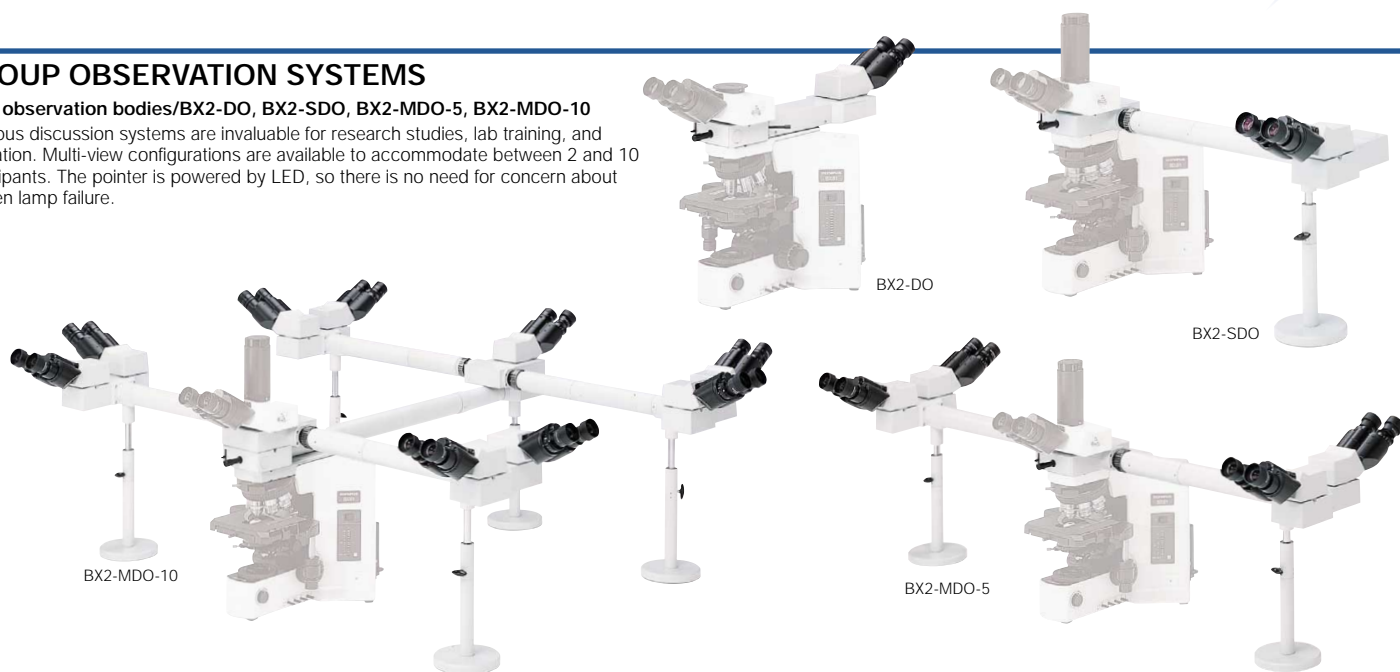

## INTERMEDIATE UNITS



### Dual port/U-DP

The dual port may be used for a variety of purposes: separating the image by spectral composition (e.g. directing fluorescence to one port, infrared to the other), as an illumination port for adding a new incident light source or as a C-mount compatible trinocular port for image output. A 1X image formation lens is also provided.



### Trinocular intermediate attachments/ U-TRU, U-TRUS

This intermediate trinocular attachment can be used simultaneously with the inclinable binocular observation tube (U-TBI-3). Two light paths are selectable: 100% light for binocular observation or 20% for binocular observation and 80% for imaging through the trinocular port.



### Drawing attachment/U-DA

The drawing attachment projects an image of the pencil and drawing surface into the visual field. Tracing of microscopic structures is made easier and more accurate.



### Simple polarizing attachment

Simple polarizing observation can be accomplished with the combination of U-KPA intermediate attachment for simple polarizing observation, U-ANT analyzer for transmitted light and U-POT polarizer.



### Magnification changer/U-CA

This intermediate magnification changer expands the capability of UIS2 objectives, optimizing the imaged field without the interruption of rotating the objective lens: 1X / 1.25X / 1.6X / 2X



### Magnification changer/U-ECA, U-ECA1.6X

This intermediate magnification changer expands the capability of UIS2 objectives, optimizing the imaged field without the interruption of rotating the objective lens: U-ECA: 1X / 2X, U-ECA1.6X: 1X / 1.6X



### Arrow pointer/U-APT

Enables insertion of a red or green LED arrow for display on a monitor or for reproduction with a photomicrograph.



### Filter cassette/U-FC

Use of this cassette enables fast exchange among three filters (with ø45mm and below 2.8mm thickness).

## CAMERA ADAPTERS

### TR-Adapters

The single port tube of the trinocular tube is detachable, and can be used with various cameras via a range of adapters. Using the U-TV1X-2, video can be shot directly with no need for a shooting lens. The potential of your microscope is greatly increased by its multiple image utilization capabilities.

### Camera adapters



- ① U-PMTVC
- ② U-PMTV
- ③ U-PMTV1X
- ④ U-SMAD
- ⑤ U-CMAD3
- ⑥ U-TMAD
- ⑦ U-BMAD
- ⑧ U-FMT
- ⑨ U-TV0.25XC
- ⑩ U-TV0.5X
- ⑪ U-TVZ
- ⑫ U-TV0.35XC-2
- ⑬ U-TV0.5XC-3
- ⑭ U-TV1X-2

**BX51/61 specifications**

		BX51	BX61
Microscope frame	Optical system	UIS2 optical system	
	Focus	Vertical stage movement: 25mm Stage stroke with coarse adjustment limit stopper Torque adjustment for coarse adjustment knobs Stage mounting position variable High sensitivity fine focusing knob (minimum adjustment gradations: 1µm)	Motorized focus/vertical stage movement: 25mm, 0.01µm increments, maximum speed: 3mm/s, coarse/fine changeover button, stage shunting button and stage up/down button
	Illuminator	Built-in Koehler illumination for transmitted light 12V100W halogen bulb Light preset switch Light intensity LED indicator Built-in filters (LBD-IF, ND6, ND25, option)	
Revolving nosepiece		Interchangeable reversed quintuple/sextuple/septuple nosepiece Motorized sextuple revolving nosepiece with slider slot for DIC Septuple revolving nosepiece for DIC/simple POL	
Observation tube	Widefield (F.N. 22)	<ul style="list-style-type: none"> <li>•Widefield binocular, inclined 30°</li> <li>•Widefield tilting binocular, inclined 5°-35°</li> <li>•Widefield trinocular, inclined 30°</li> <li>•Widefield tilting/telescoping binocular, inclined 0°-25°, telescoping 0-45mm</li> </ul>	
	Super widefield (F.N. 26.5)	Super widefield trinocular, inclined 24°	
Stage		Ceramic-coated coaxial stage with left or right hand low drive control: with rotating mechanism and torque adjustment mechanism, optional rubber grips available (Non stick grooved coaxial, plain, rotatable stages are also available)	
Condenser		<ul style="list-style-type: none"> <li>•Abbe (N.A. 1.1), for 4x—100x</li> <li>•Swing out Achromatic (N.A. 0.9), for 1.25x—100x (swing-out: 1.25x—4x)</li> <li>•Achromatic Aplanatic (N.A. 1.4), for 10x—100x</li> <li>•Universal (N.A. 1.4/0.9), for 2x—100x (swing-out: 2x—4x, with oil top lens: 20x—100x)</li> </ul>	
Motorized fluorescence illuminator * <sup>3</sup>		Motorized reflected fluorescence, 6-position mirror turret unit, motorized shutter changeover speed: shutter speed: 0.1 s	
Motorized universal condenser * <sup>3</sup>		8-position with motorized AS, turret and top lens swing out mechanism (N.A. 1.4—0.9), for 1.25x* <sup>1+2</sup> —100x	
Motorized transmitted filter wheel * <sup>3</sup>		To be mounted on light exit, 6 positions, ø32, filter thickness: up to 6mm	
Motorized reflected filter wheel * <sup>3</sup>		To be mounted between the lamphouse and the frame, 6 positions, ø25/ø32, filter thickness: up to 6mm	
Motorized observation filter wheel * <sup>3</sup>		To be mounted between the frame and the observation tube, 6 positions, ø25/ø32, filter thickness: up to 6mm	
Hand switch * <sup>3</sup>		Control of septuple revolving nosepiece, 6-position mirror turret illumination unit and 8-position condenser	
Control box * <sup>3</sup>		Serial interface RS232C, built-in transmitted/reflected halogen power supply	

\*<sup>1</sup> Slight vignetting may occur in the periphery of the field due to the top lens. This occurs in observation only. \*<sup>2</sup> U-FWCO 1.25x should be mounted on U-FWT \*<sup>3</sup> Optional

**BX51 dimensions**

(unit: mm)

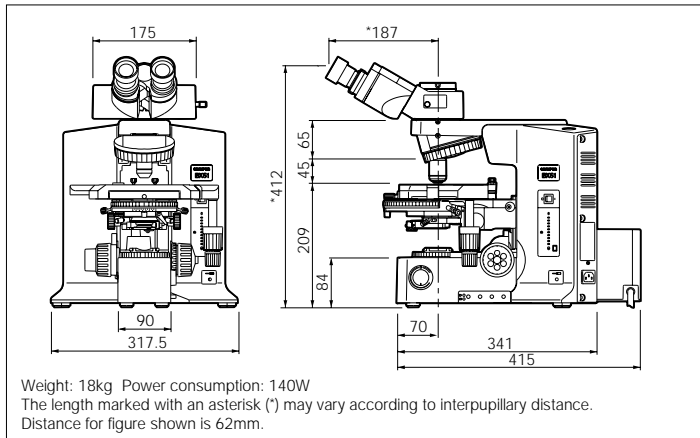

**BX61 dimensions**

(unit: mm)

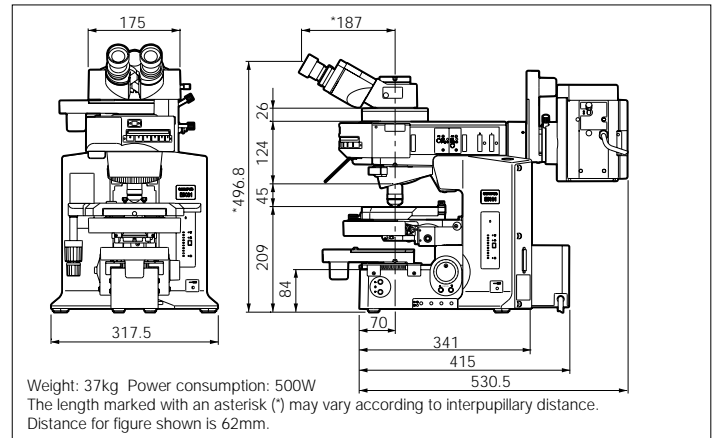

**BX51+BX-RFA dimensions**

(unit: mm)

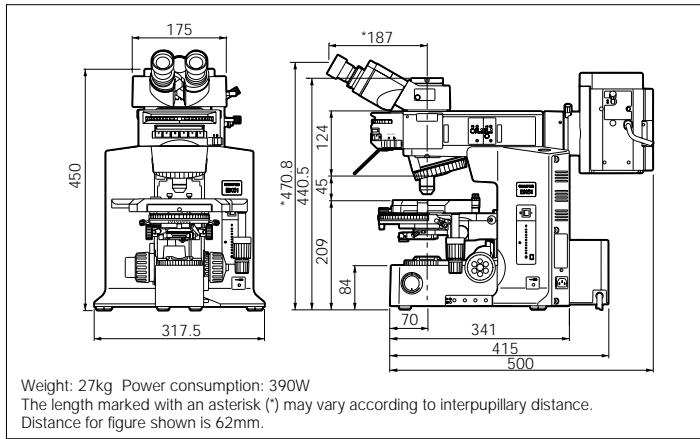

**BX-UCB dimensions**

(unit: mm)

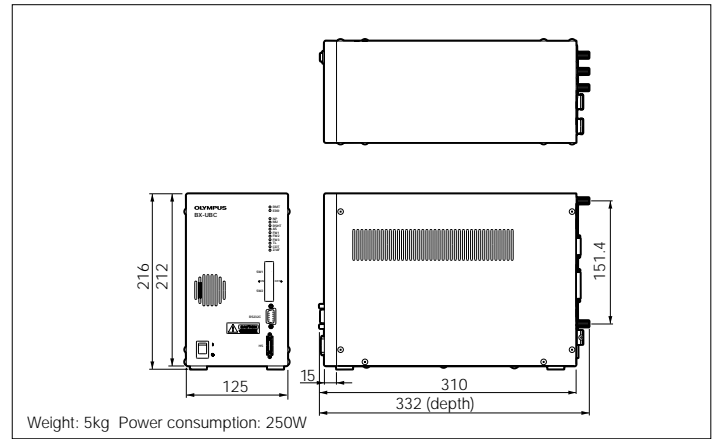

**BX51+U-DO3 dimensions**

(unit: mm)

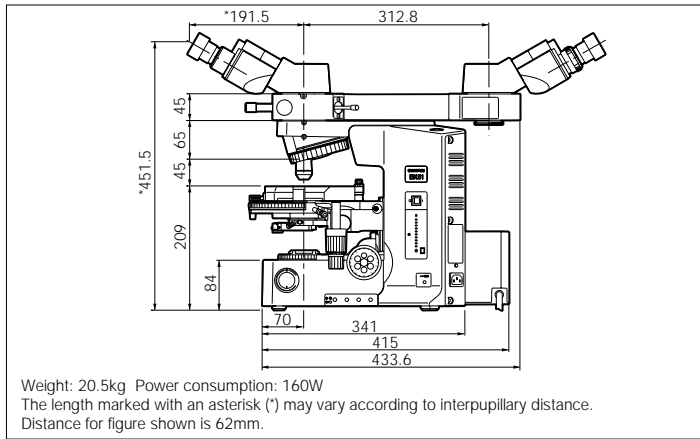

**U-HSTR2 dimensions**

(unit: mm)

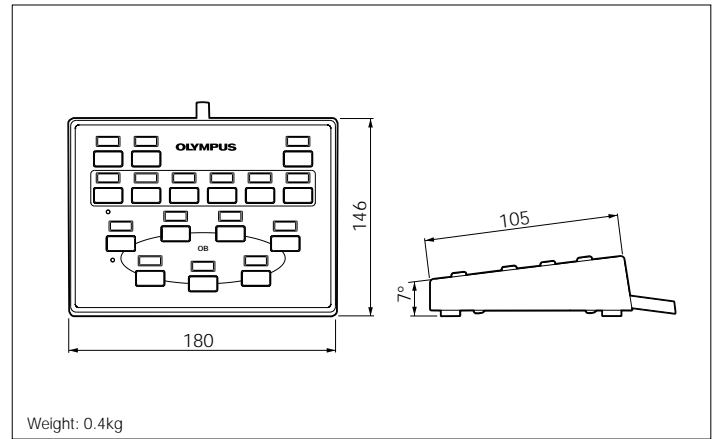

**BX51+U-MDO10 dimensions**

(unit: mm)

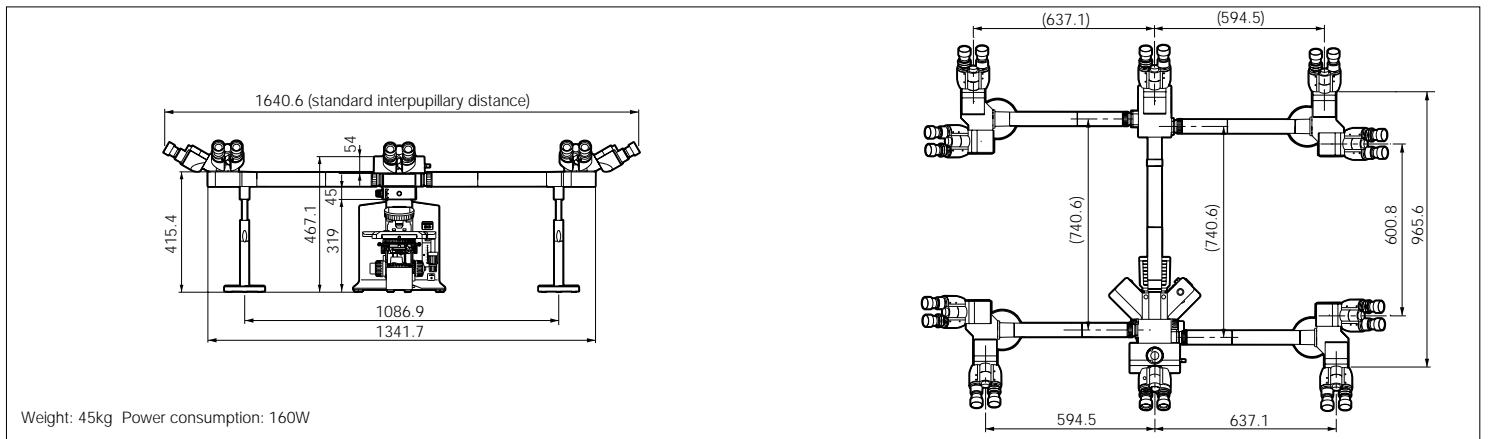

SYSTEM DIAGRAM

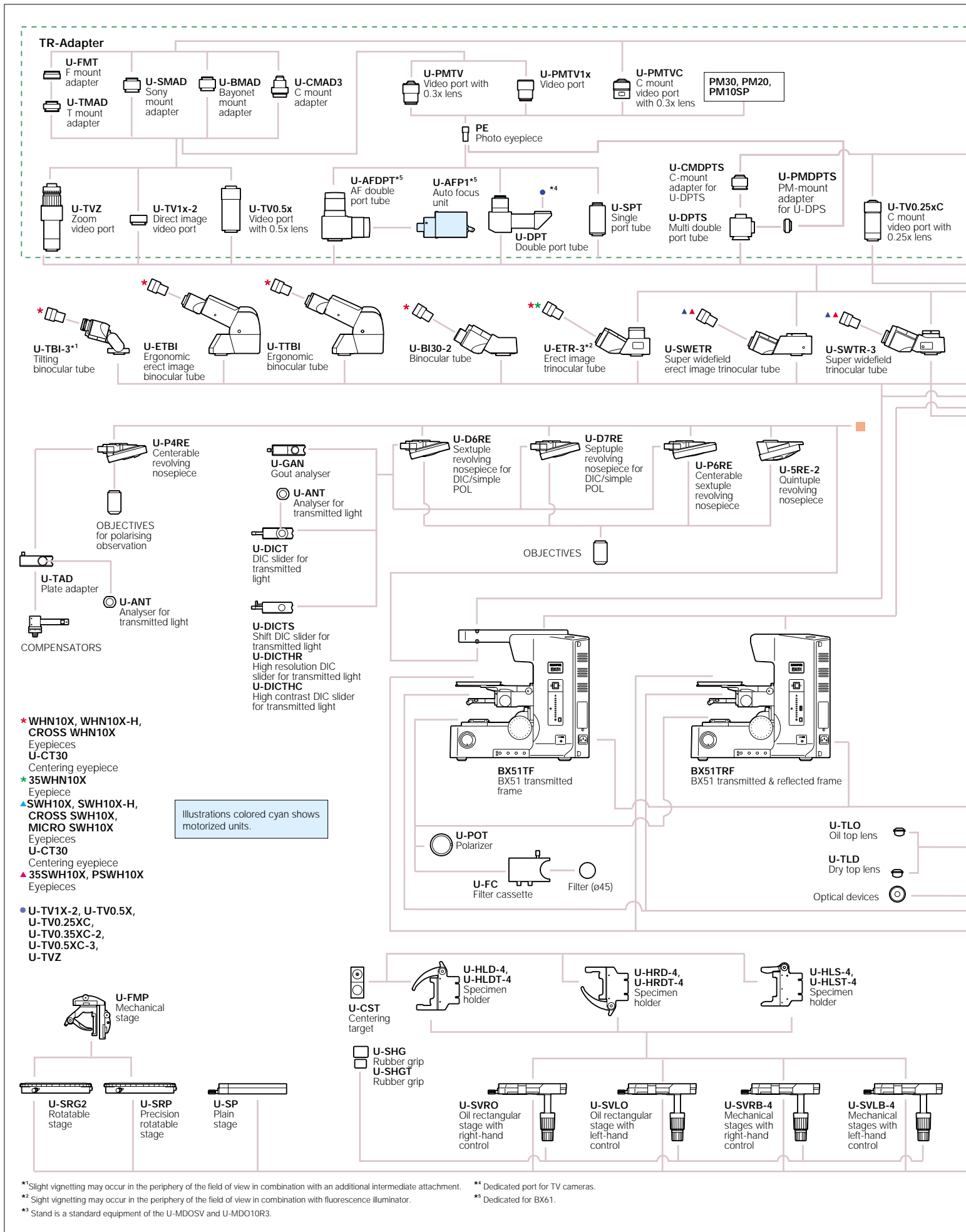

**MICROSCOPE  
DIGITAL CAMERAS,  
ANALOG CAMERAS**

**U-TV0.35x C-2**  
C mount video port with 0.35x lens

**U-TV0.5x C-3**  
C mount video port with 0.5x lens

**U-TR30NIR**  
Trinocular tube

**U-TR30-2**  
Trinocular tube

**U-ECA**  
Magnification changer 2x  
**U-ECA1.6x**  
Magnification changer 1.6x

**U-ANT**  
Analyser for transmitted light

**U-KPA**  
Intermediate attachment for simple polarising observation

**U-CA**  
Magnification changer

**U-DP\***  
Dual port

**U-DP1xC**  
Dual port 1x

**U-TRU\*2**  
Trinocular intermediate attachment

**U-TRUS\*2**  
Trinocular intermediate attachment

**U-APT**  
Arrow pointer

**U-EPA2**  
Eyepoint adjuster

**U-CPA**  
Intermediate attachment for conoscopic and orthoscopic observation

**U-OPA**  
Intermediate attachment for orthoscopic observation

**U-DA**  
Drawing attachment

**U-DO3**  
Dual observation attachment

**U-SDO3**  
Side by side observation attachment

**U-MDOB3**  
Multi observation body

**U-MDOSV\*3**  
Multi observation side viewer

**U-MDO10B3**  
Multi observation body for 10 persons

**U-MDO10R3\*3**  
Multi observation body for 10 persons

**U-AN360P-2**  
Rotatable analyser

**U-DAL10x**  
Drawing attachment 10x

**Stand\*3**

**U-FWO**  
Observation filter wheel

**BX-RFAA**  
Motorized fluorescence illuminator

**MIRROR UNITS**

**U-D6REM**  
Motorized sextuple revolving nosepiece for DIC/simplePOL

**U-EXBABG**  
Excitation balancer BG

**U-EXBAUB**  
Excitation balancer UB

**U-EXBAUG**  
Excitation balancer UG

**U-FWR**  
Reflected filter wheel

**U-25ND6-2, U-25ND25-2, U-25ND50-2**  
ND filter

**U-RFSS**  
Rectangular field stop

**BX-RFSPOT**  
Rectangular field stop

**U-RSL6**  
6 position filter slider

**U-RSL6EM**  
6 position filter slider

**U-AN**  
Analyser for reflected light

**BX-URA2**  
BX reflected light illuminator

**U-RSL6**  
6 position filter slider

**U-RSL6EM**  
6 position filter slider

**U-AN**  
Analyser for reflected light

**U-25ND6-2, U-25ND25-2, U-25ND50-2**  
ND filter

**U-EXBABG**  
Excitation balancer BG

**U-EXBAUB**  
Excitation balancer UB

**U-EXBAUG**  
Excitation balancer UG

**MIRROR UNITS**

**BX-RFA**  
BX fluorescence illuminator

**U-RFSS**  
Rectangular field stop

**BX-RFSPOT**  
Rectangular field stop

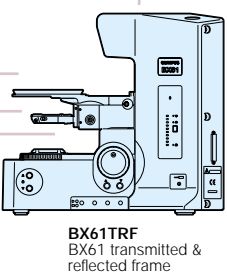

**BX61TRF**  
BX61 transmitted & reflected frame

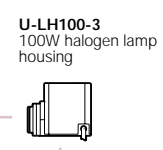

**U-LH100-3**  
100W halogen lamp housing

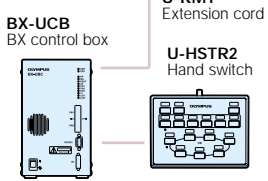

**BX-UCB**  
BX control box

**U-HSTR2**  
Hand switch



**U-AC2**  
Abbe condenser

**U-SC3**  
Swing-out condenser

**U-AAC**  
Achromatic/Aplanatic condenser

**U-ULC-2**  
Ultra low condenser

**U-PCD2**  
Phase/darkfield condenser

**U-POC-2**  
Polarising condenser

**U-DCD**  
Darkfield condenser, dry

**U-DCW**  
Darkfield condenser, oil

**U-UCDTP530**  
Tint plate for sensitive color observation

**U-UCD8**  
8 position universal condenser

**U-TLO**  
Oil top lens

**U-TLD**  
Dry top lens

**Optical devices**

**U-DULHA**  
Double lamp house adapter

**U-LH75XEAP0**  
75W xenon apo lamp housing

**U-LH100HGAP0**  
100W mercury apo lamp housing

**U-LH100HG**  
100W mercury lamp housing

**U-LH50MH**  
50W metal halide lamp housing

**Power source for 75W xenon lamp**

**Power source for 100W mercury lamp**

**U-PS50MH**  
Power source for 50W metal halide lamp



Specifications are subject to change without any obligation on the part of the manufacturer.

Photos courtesy of:

*Junko Kyojuka, Associate Professor, Graduate School of Agricultural and Life Sciences, The Tokyo University (P.11 below)*

*Prof. Nakatani, Biochemistry course, School of medicine, Showa University (P.13 above)*

*Prof. Tadokoro, Pathology class, School of medicine, St. Marianna University (P.15)*

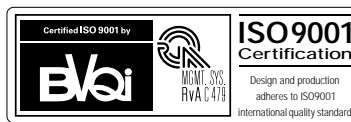

**OLYMPUS®**

**OLYMPUS CORPORATION**  
Shinjuku Monolith, 3-1, Nishi Shinjuku 2-chome, Shinjuku-ku, Tokyo, Japan

**OLYMPUS EUROPA GMBH**  
Postfach 10 49 08, 20034, Hamburg, Germany

**OLYMPUS AMERICA INC.**  
Two Corporate Center Drive, Melville, NY 11747-3157, U.S.A.

**OLYMPUS SINGAPORE PTE LTD.**  
491B River Valley Road, #12-01/04 Valley Point Office Tower, Singapore 248373

**OLYMPUS UK LTD.**  
2-8 Honduras Street, London EC1Y 0TX, United Kingdom.

**OLYMPUS AUSTRALIA PTY. LTD.**  
31 Gilby Road, Mt. Waverley, VIC 3149, Melbourne, Australia.  
**OLYMPUS LATIN AMERICA, INC.**  
6100 Blue Lagoon Drive, Suite 390 Miami, FL 33126-2087, U.S.A.

www.olympus.com



This catalog is printed by environmentally-friendly waterless printing system with soy ink.

Printed in Japan M1540E-1004B