



DIONEX

IC20 ION CHROMATOGRAPH OPERATOR'S MANUAL

© 1999 Dionex Corporation

Now sold under the
Thermo Scientific brand

Thermo
S C I E N T I F I C

Document No. 031274

Revision 03

June 1999

©1999 by Dionex Corporation
All rights reserved worldwide.
Printed in the United States of America.

This publication is protected by federal copyright law. No part of this publication may be copied or distributed, transmitted, transcribed, stored in a retrieval system, or transmitted into any human or computer language, in any form or by any means, electronic, mechanical, magnetic, manual, or otherwise, or disclosed to third parties without the express written permission of Dionex Corporation, 1228 Titan Way, Sunnyvale, California 94088-3603 U.S.A.

DISCLAIMER OF WARRANTY AND LIMITED WARRANTY

THIS PUBLICATION IS PROVIDED “AS IS” WITHOUT WARRANTY OF ANY KIND. DIONEX CORPORATION DOES NOT WARRANT, GUARANTEE, OR MAKE ANY EXPRESS OR IMPLIED REPRESENTATIONS REGARDING THE USE, OR THE RESULTS OF THE USE, OF THIS PUBLICATION IN TERMS OF CORRECTNESS, ACCURACY, RELIABILITY, CURRENTNESS, OR OTHERWISE. FURTHER, DIONEX CORPORATION RESERVES THE RIGHT TO REVISE THIS PUBLICATION AND TO MAKE CHANGES FROM TIME TO TIME IN THE CONTENT HEREINOF WITHOUT OBLIGATION OF DIONEX CORPORATION TO NOTIFY ANY PERSON OR ORGANIZATION OF SUCH REVISION OR CHANGES.

TRADEMARKS

SRS® and Self-Regenerating Suppressor® are registered trademarks and DX-LAN™ is a trademark of Dionex Corp.

PRINTING HISTORY

Revision 01, March 1997

Revision 02, May 1998

Revision 03, June 1999

1 • Introduction

| | | |
|-------|---------------------------------|-----|
| 1.1 | Overview | 1-1 |
| 1.2 | About This Manual | 1-2 |
| 1.2.1 | Typefaces | 1-3 |
| 1.2.2 | Safety Messages and Notes | 1-3 |
| 1.2.3 | Symbols | 1-4 |

2 • Description

| | | |
|-------|---------------------------------------------|------|
| 2.1 | Front Control Panel | 2-2 |
| 2.1.1 | Control Panel Keypad | 2-3 |
| 2.1.2 | Initial Display Screens | 2-6 |
| 2.2 | Electronics Chassis | 2-7 |
| 2.2.1 | Connectors | 2-8 |
| 2.2.2 | Cards | 2-9 |
| 2.3 | Mechanical Chassis | 2-11 |
| 2.4 | Interior Components | 2-11 |
| 2.4.1 | Pump Heads | 2-11 |
| 2.4.2 | Pump Priming Block | 2-13 |
| 2.4.3 | Pressure Transducer | 2-13 |
| 2.5 | Conductivity Cell | 2-14 |
| 2.6 | Vacuum Degas Pump Assembly (Optional) | 2-15 |
| 2.7 | Eluent Reservoirs | 2-16 |
| 2.8 | Rear Panel | 2-16 |

2.9 Functional Description 2-17

 2.9.1 Operating Modes 2-19

 2.9.2 Method Control 2-20

3 • Operation and Maintenance

3.1 Getting Ready to Run 3-1

 3.1.1 Degas Eluents 3-1

 3.1.2 Filter Eluents 3-2

 3.1.3 Pressurize Eluent Reservoirs 3-2

 3.1.4 Start-Up 3-3

 3.1.5 Selecting the Pressure Limits 3-4

3.2 Running Under Direct Control 3-5

3.3 Running Under Method Control 3-6

 3.3.1 Creating a New Method 3-7

 3.3.2 Running a Method 3-9

 3.3.3 Controlling the Method Clock 3-9

 3.3.4 Editing a Method 3-10

 3.3.5 Deleting a Method 3-11

 3.3.6 Changing the Running Method 3-11

3.4 Optimizing Temperature Compensation 3-11

3.5 Shutdown 3-12

3.6 Routine Maintenance 3-12

 3.6.1 Daily Maintenance 3-12

 3.6.2 Periodic Maintenance 3-14

4 • Troubleshooting

| | | |
|------|----------------------------------------------------------------|------|
| 4.1 | Left-Right Pump Head Pressure Fluctuations | 4-1 |
| 4.2 | Pump Will Not Start | 4-3 |
| 4.3 | Pump Stops | 4-3 |
| 4.4 | Liquid Leaks/Leak Alarm | 4-6 |
| 4.5 | High-Pitched Noise From Pump Motor (or Motor Racing) | 4-7 |
| 4.6 | Vacuum Degas Pump Does Not Run | 4-8 |
| 4.7 | Vacuum Degas Pump Calibration Fails | 4-9 |
| 4.8 | Vacuum Degas Pump Low Vacuum | 4-10 |
| 4.9 | Inoperative Relay Control Function | 4-10 |
| 4.10 | Poor Chromatographic Reproducibility | 4-11 |
| 4.11 | No Detector Response | 4-11 |
| 4.12 | Low Detector Output | 4-12 |
| 4.13 | High Detector Output | 4-12 |
| 4.14 | Noisy or Drifting Baseline | 4-12 |
| 4.15 | Conductivity Inaccurate | 4-13 |
| 4.16 | Faulty DX-LAN Communication | 4-14 |

5 • Service

| | | |
|-----|--------------------------------------------------------------|------|
| 5.1 | Cleaning and Replacing the Check Valves | 5-2 |
| 5.2 | Piston Seal Replacement | 5-4 |
| 5.3 | Pump Piston Replacement | 5-8 |
| 5.4 | Pressure Transducer Waste Valve O-Ring Replacement | 5-9 |
| 5.5 | Changing Main Power Fuses | 5-10 |

5.6 Eliminating Liquid Leaks 5-11

5.7 Removing Trapped Air from the Cell 5-11

5.8 Calibrating the Cell 5-12

A • Specifications

A.1 Electrical A-1

A.2 Environmental A-1

A.3 Physical A-1

A.4 Display and Keypad A-1

A.5 Hydraulics A-2

A.6 Conductivity Detector A-2

A.7 Conductivity Cell A-2

A.8 SRS Power Supply A-3

A.9 Vacuum Degas Assembly (Optional) A-3

A.10 Method Control A-3

B • Installation

B.1 Facility Requirements B-1

B.2 Rear Panel Connections B-2

 B.2.1 Power Connection B-2

 B.2.2 Waste Lines B-3

 B.2.3 DX-LAN Network Connection (Optional) B-4

B.3 Electronics Chassis Connections B-7

B.4 Eluent Reservoir Connections B-8

B.4.1 Eluent Inlet Line Connection B-8

B.4.2 Eluent Outlet Line Connection B-8

B.5 Priming the Pump B-9

 B.5.1 Priming Using the Priming Block B-9

 B.5.2 Priming Using the Prime Button B-11

 B.5.3 Priming the Pump Heads with Isopropyl Alcohol B-12

B.6 Automatic SRS Power Control (Optional) B-13

C • User Interface

C.1 Operational Screens C-3

 C.1.1 Main Screen C-3

 C.1.2 Detail Screen C-5

 C.1.3 Method Screen C-6

 C.1.4 Module Setup C-8

 C.1.5 Pump Options C-9

 C.1.6 Time Function In C-10

 C.1.7 Degas Options C-11

 C.1.8 Analog Out Setup C-13

C.2 Diagnostic Screens C-14

 C.2.1 Diagnostic Menu C-14

 C.2.2 Power-Up Screen C-15

 C.2.3 Elapsed Time C-16

 C.2.4 DSP Status C-17

 C.2.5 Keyboard Test C-18

 C.2.6 Signal Statistics C-19

 C.2.7 Diagnostic Test C-20

 C.2.8 Pressure Statistics C-21

- C.3 Calibration ScreensC-22
 - C.3.1 Calibration MenuC-22
 - C.3.2 Calibration StatusC-23
 - C.3.3 Leak Sensor Calibration and StatusC-24
 - C.3.4 Degas Pump Calibration.C-25
 - C.3.5 Flow CalibrationC-26
 - C.3.6 Pressure CalibrationC-27
 - C.3.7 Calibrate Conductivity CellC-31

D • TTL and Relay Control

- D.1 TTL and Relay Output OperationD-2
- D.2 TTL Input OperationD-3
 - D.2.1 Input Function Assignments.D-4
 - D.2.2 TTL Input Signal ModesD-4
- D.3 TTL and Relay ConnectionsD-6
 - D.3.1 Example Connections.D-7

Index

1.1 Overview

The IC20 Ion Chromatograph performs isocratic ion analyses using conductivity detection. The IC20 integrates pump and detector functions in a single instrument. The microprocessor-based, dual-piston, variable-speed, delivery system pumps eluents at precisely controlled flow rates. The IC20 electronics provide sensitive, accurate detection and quantification of ionic analytes in liquid and ion chromatography. This is especially useful for analytes that lack UV chromophores and cannot be determined with adequate sensitivity by UV absorbance. A Digital Signal Processor (DSP) provides high speed control of pump flow and pressure.

The IC20 can operate with non-Dionex modules that meet the IC20 interface requirements for software, TTL, or relay control.

The IC20 can be controlled locally, from the front panel keypad and display, or from a remote host computer with a Dionex DX-LAN™ interface installed and PeakNet software (Release 5.1 or higher) installed on the host computer. Limited remote control is also available using TTL signals.

The IC20 is available in three versions (all plumbed with PEEK tubing):

- P/N 051999 includes a single-chamber vacuum degas pump.
- P/N 051905 includes a double-chamber vacuum degas pump, as well as an eluent selection valve that allows switching between two eluents.
- The standard IC20 (P/N 051601) does not include a vacuum degas pump or eluent selection valve.

The two basic modes of IC20 control, Method control and Direct control, enable it to operate with or without reference to time-based events.

For applications requiring a controlled above-ambient temperature environment for the chromatography components (the analytical column, detector cell, etc.), Dionex recommends operating the IC20 with an LC25 Chromatography Oven. The LC25 operates over a range of 30 to 45 °C (86 to 113 °F), settable in one-degree increments. The temperature is selected from the IC20 front panel.

1.2 About This Manual

| | |
|--------------------------------------------|------------------------------------------------------------------------------------------------------------|
| Chapter 1, Introduction | Introduces the IC20 and explains the conventions used in the manual, including safety-related information. |
| Chapter 2, Description | Describes the IC20 operating features, the control modes, and the chromatographic fluid path. |
| Chapter 3, Operation and Maintenance | Provides procedures for operation and routine preventive maintenance. |
| Chapter 4, Troubleshooting | Lists problems, with step-by-step procedures to isolate and eliminate their sources. |
| Chapter 5, Service | Provides step-by-step instructions for routine service and parts replacement procedures. |
| Appendix A, Specifications | Lists the IC20 specifications and installation site requirements. |
| Appendix B, Installation | Describes how to install the IC20. |
| Appendix C, User Interface | Illustrates and describes the front panel operating and diagnostic screens. |
| Appendix D, Relay and TTL Control | Describes the relay and TTL input and output functions and provides setup examples. |

1.2.1 Typefaces

Typefaces are used in this manual as follows:

- Capitalized bold type indicates a front panel button:
Press **Enter** to begin running the method.
- Upper-case bold type indicates the name of a screen, the name of a menu, or an on-screen entry:
Go to the **METHOD** screen.
Move the cursor to the **EDIT** field.

1.2.2 Safety Messages and Notes

The IC20 meets European, EMC, and safety requirements per Council Directives 73/23/EEC and 89/336/EEC, EN 61010-1:1993 (safety), EN 50082-1:1992 (susceptibility), and EN 55011:1991 (emissions). The TUV/CE and GS safety label on the IC20 attests to compliance with these standards.

Do not use the IC20 for any purpose other than for which it is designed. If there is a question regarding appropriate usage, contact Dionex before proceeding.

This manual contains warnings and precautionary statements that can prevent personal injury and/or damage to the instrument when properly followed. Safety messages appear in bold type and are accompanied by icons.



Indicates an imminently hazardous situation which, if not avoided, will result in death or serious injury.



Indicates a potentially hazardous situation which, if not avoided, could result in death or serious injury.



Indicates a potentially hazardous situation which, if not avoided, may result in minor or moderate injury.



Indicates that the function or process of the instrument may be impaired. Operation does not constitute a hazard.

Informational messages also appear throughout this manual. These are labeled NOTE and are in bold type:

NOTE NOTES call attention to certain information. They alert you to an unexpected result of an action, suggest how to optimize instrument performance, etc.

1.2.3 Symbols

The symbols below appear on the IC20, or on IC20 labels.



Alternating current



Protective conductor terminal



Power supply is on



Power supply is off

2 • Description

The IC20 Ion Chromatograph consists of two single-unit enclosures (see Figure 2-1). The upper unit houses the electronics components, while the lower unit contains the pump heads and other mechanical pump assemblies.

Other single- or dual-unit Dionex modules may be stacked on top of the IC20. The maximum height is four units.

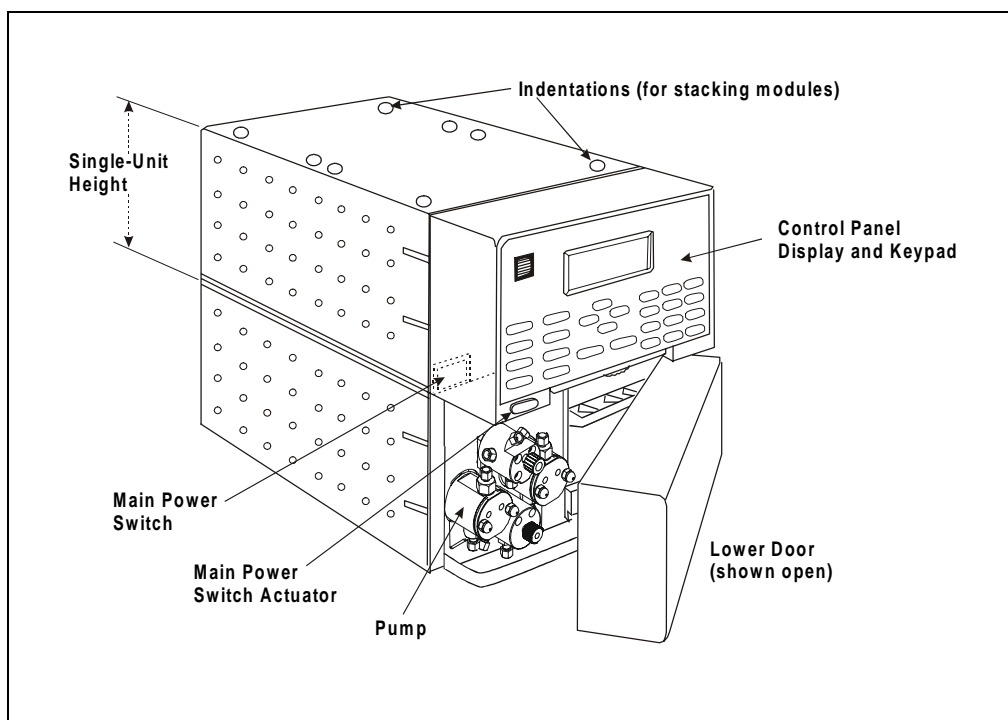

Figure 2-1. IC20 Operating Features (Exterior)

2.1 Front Control Panel

The control panel on the upper door of the IC20 contains the liquid crystal display (LCD), the membrane keypad, and the actuator for the main power switch (see Figure 2-1). The door opens to provide access to the electronics chassis, described in Section 2.2.

Screen Contrast

Information is displayed on the LCD, also called the *screen*. To adjust the screen contrast, use the knurled knob in the recess below the keypad (see Figure 2-2).

Tilt Panel

To maximize visibility, the front control panel can be tilted to four different positions. To tilt the panel, support the door at the left side (to prevent it from opening) and lift firmly on the tab in the middle of the recess below the keypad (see Figure 2-2). Push on the tab to return the panel to its vertical position.

Power Switches

The main power switch is on the bulkhead behind the upper door (see Figure 2-1). An actuator for the main power switch is on the outside of the front door, at the lower left corner. The actuator functions only when the door is fully closed.

When the door is open, press the main power switch on the bulkhead, instead of the actuator, to turn the module off and on.



To prevent damage to the IC20 circuitry and components, always wait at least 15 seconds after powering down before turning on the power again.

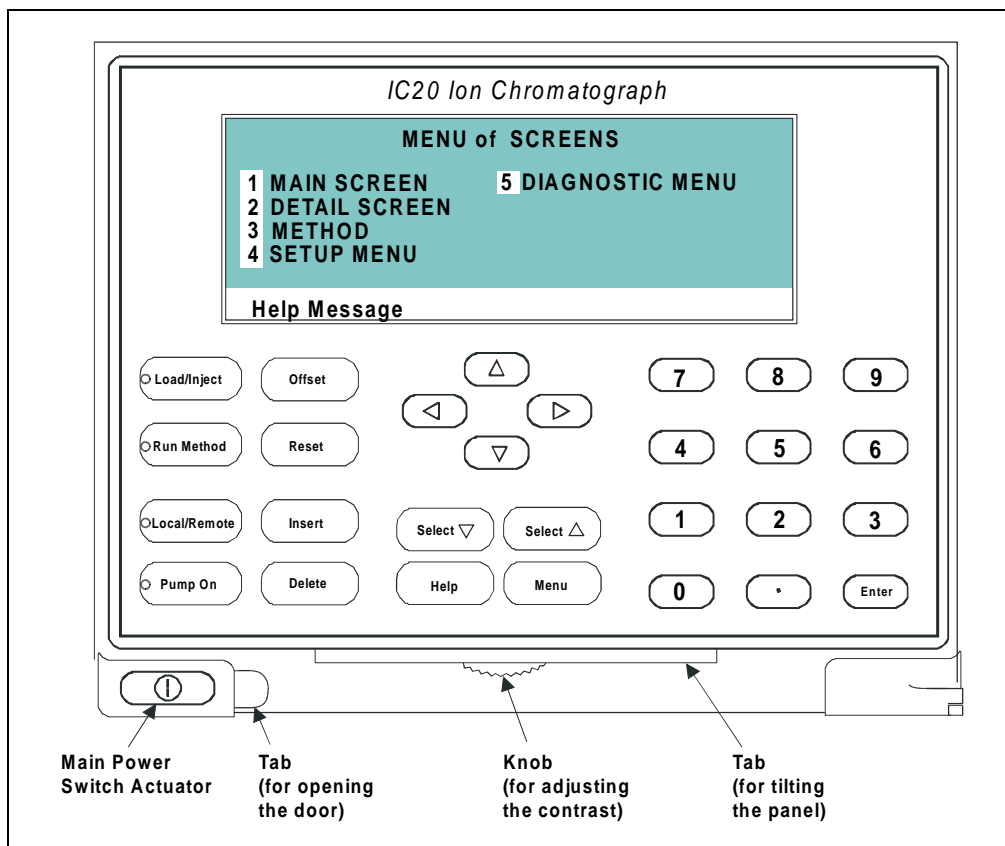

Figure 2-2. IC20 Display and Keypad Layout

2.1.1 Control Panel Keypad

Use the keypad to directly control IC20 operation, as well as to create and modify programmed series of timed events, called *methods*. In summary:

- Press **Menu** to display a list of available screens.
- In the screens, only screen fields shown in reverse video can be edited. Other fields only display information.
- To edit a field, use the four directional arrow buttons to position the cursor in the reverse video fields. Use the numerical buttons to enter variable values.

- Use the **Select** ▾ and **Select** △ buttons to choose between predetermined options. Pressing a **Select** button increases (or decreases) a numerical value by one; holding down a **Select** button increases (or decreases) a numerical value continuously.
- Press **Enter** or a cursor arrow button to execute the selected value.

A high-pitched beep sounds when a button is pressed. When an error occurs, this beep is lower in frequency. The beeps can be disabled from the **MODULE SETUP** screen (see Section C.1.4).

| Button | Function |
|---------------------|---------------------------------------------------------------------------------------------------------------------------------------------------------------------------------------------------------------------------------------------------------------------------------------------------------------------------------------------------------------------------------------------------------------------------------------------------------------------------------------------------------------------------------------------------------------------------------------------------------------------------------------------------------------------------------------------|
| Load/Inject | Switches the position of the injection valve between Load and Inject. |
| Run Method | Turns the method clock on and off. This button functions only when the IC20 is in Method control. |
| Local/Remote | Switches from Local to Remote operation. |
| Pump On | Turns the pump on and off. |
| Offset | Returns the analog (recorder) output to a predetermined baseline and zeros the display. The resultant value of the offset required is displayed on the DETAIL screen. This function can be programmed in a method. |
| Reset | Changes the method clock time to INIT and causes the initial conditions specified by the method to occur. This button functions only when the IC20 is in Method control. |
| Insert | Inserts a new timed step into a method. This button functions only when the cursor is in a TIME field on the METHOD or METHOD extension screen. <ol style="list-style-type: none">1. Move the cursor to the TIME field and press Insert. This adds a new step after the cursor position. Parameter values in the new step will be blank.2. Fill in the time value and press Enter or a cursor arrow button. (If the cursor is moved to a different field before a time value is entered, the inserted step disappears.) Continue inserting timed steps in any order; they will automatically be organized chronologically. |

Table 2-1. Control Panel Button Functions

| Button | Function |
|------------------------------------|----------------------------------------------------------------------------------------------------------------------------------------------------------------------------------------------------------------------------------------------------------------------------------------------------------------------------------------------------------------------------------------------------------------------------------------------------------------------------------------------------------------------------------------------------------------------------------------------------------------------------------------------------------------------|
| Delete | Removes the value from the current entry field, allowing entry of a new value. To restore the previous value, move the cursor from the field before entering the new value. |
| ←, ↑, →, ↓ | Moves the cursor, in the direction of the arrow, to the next entry field. When there is no changeable field in that direction, the cursor moves diagonally or remains where it is. |
| Select ▽ Select △ | <p>When the cursor is in a field with predetermined parameters, these buttons cycle through the choices. In fields with predetermined numerical values, Select △ increases the value by one unit and Select ▽ decreases the value by one unit.</p> <p>Holding down a Select button increases (or decreases) the value continuously. To execute the new value, press Enter or a cursor arrow button.</p> |
| Help | Displays a help screen pertaining to the current entry field. |
| Menu | <p>Displays one of three menus, depending on the current screen:</p> <ul style="list-style-type: none"> • From an operational or setup screen, pressing Menu displays the MENU of SCREENS. • From a diagnostic screen, pressing Menu once displays the DIAGNOSTIC MENU. Pressing Menu again redisplay the MENU of SCREENS. • From a calibration screen, pressing Menu once displays the CALIBRATION MENU. Pressing Menu again redisplay the DIAGNOSTIC MENU and then the MENU of SCREENS. <p>See Figure C-1 for an overview of the menu structure.</p> |
| Numerical Buttons | Enters 0 through 9 and a decimal into the current entry field. |
| Enter | <p>Saves and/or executes changes made in entry fields. After pressing Enter, the cursor returns to the left margin of the field.</p> <p>On menu screens, pressing Enter opens the highlighted screen.</p> <p>On the METHOD screen pressing Enter saves entries to an edit copy only. To save editing changes to a permanent method move the cursor to the SAVE TO field enter a method number and press Enter.</p> |

Table 2-1. Control Panel Button Functions (Continued)

2.1.2 Initial Display Screens

When the IC20 has successfully powered-up and passed all diagnostic tests, the **POWER-UP** screen (see Figure 2-3) displays briefly, followed by the **MAIN** screen (see Figure 2-4). If one of the diagnostic tests fails at power-up, the **DIAGNOSTIC TEST** screen displays instead of the **MAIN** screen. See Section C.2.7 if this occurs.

NOTE The information on the **POWER-UP** screen can be reviewed at any time by selecting the screen from the **DIAGNOSTIC MENU**.

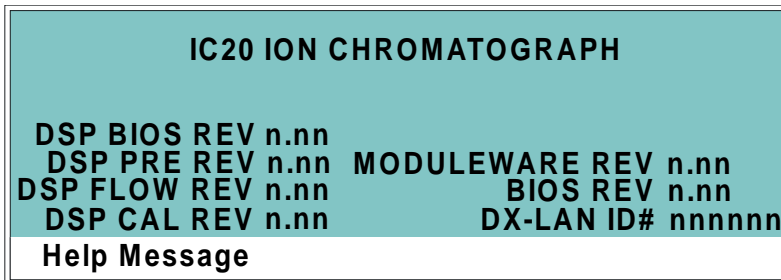

Figure 2-3. Power-Up Screen

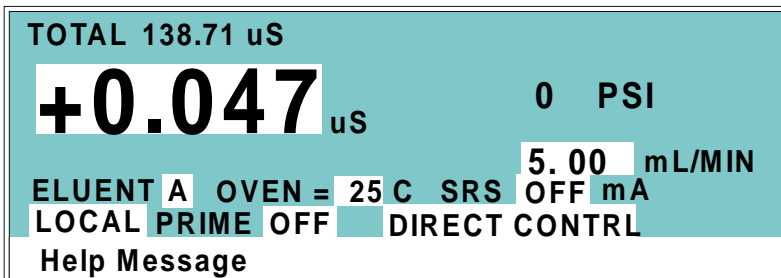

Figure 2-4. Main Screen

The **MAIN** screen displays status information in enlarged characters to facilitate viewing from a distance. Operating parameters (flow rate, method number to run, etc.) are selected here.

To access other screens, press the **Menu** button on the front panel to display the **MENU of SCREENS** (see Figure 2-5). To select an option, move the cursor to a screen name and press **Enter**, or enter the screen number on the keypad and press **Enter**. See Appendix C for a description of each screen.

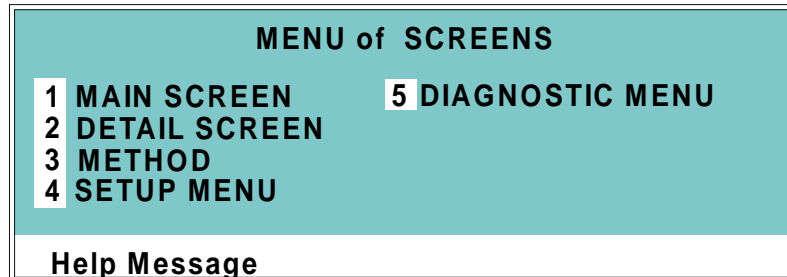

Figure 2-5. Menu of Screens

2.2 Electronics Chassis

The electronics chassis is located behind the upper door of the IC20 enclosure. The chassis includes several electronics cards (printed circuit boards) required for IC20 control. Connectors on the cards also enable the IC20 to communicate with other modules or accessories in the system. Figure 2-6 shows the electronics components with the upper door open. To open the door, pull on the tab beside the main power actuator (see Figure 2-2).



Do not remove any of the electronics cards from the IC20. There are no user-serviceable components on the cards. If servicing is required, it must be performed by qualified personnel and appropriate electrostatic discharge (ESD) handling procedures must be followed.

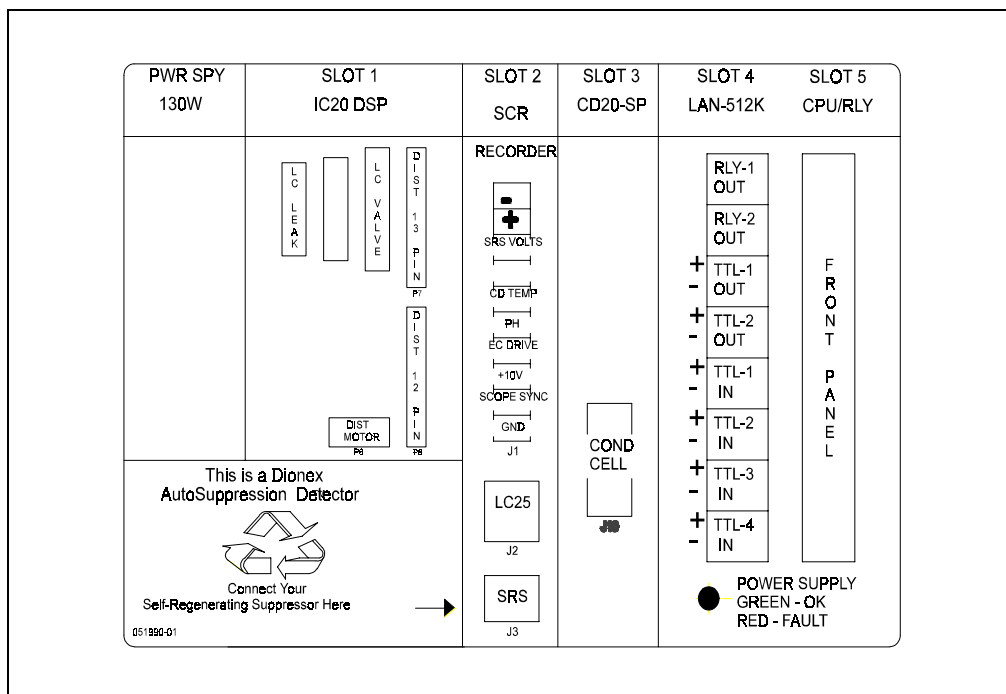

Figure 2-6. IC20 Electronics Chassis
(Located behind system door)

2.2.1 Connectors

LC VALVE

The cable from the Rheodyne injection valve in the LC25 Chromatography Oven (if installed) connects to the **LC VALVE** connector in slot 1.

TTL/Relay

A strip of eight relay and TTL connectors is located in slot 5. These connectors interface with other Dionex modules, or with non-Dionex instruments. Appendix D describes the relay and TTL functions, as well as the connections between the IC20 and other devices.

2.2.2 Cards

Power Supply Module

Provides power for the IC20 electronics.

DSP (Digital Signal Processor) Card

Contains the digital circuitry to interface to the CPU.

SCR (Supply Control/Relay) Card

Interfaces to the CPU. The SCR card contains three functions:

- 16-bit Recorder Output Digital-to-Analog Converter—Includes an electronic switch for selection of full-scale outputs of 0.01, 0.1, and 1.0 V.
- SRS[®] Power Supply—Supplies a regulated current (set by the user) of 50, 100, 300, or 500 mA to the Self-Regenerating Suppressor[®]. An over-voltage detector shuts off the power if the voltage exceeds 8.5 V. An over-temperature detector shuts off the power if the SRS temperature exceeds 40 °C. If one of these situations occurs, the SCR card sends an “SRS Alarm” error message to the CPU.
- LC25 Power Supply—Supplies heating power to the LC25 Chromatography Oven. While warming or cooling to a lower set point, a “BELOW TEMP” or “ABOVE TEMP” message is displayed. Once the set point is reached, proportional heat control maintains a constant temperature.

SP Card

Contains digital circuitry for the interface to the CPU, as well as the analog circuitry required for the IC20. The Signal Processor (SP) card contains the following functions:

- Temperature compensation digital-to-analog converter
- Cell chopper, driver
- Offset digital-to-analog scaling switch
- Conductivity signal receiver
- Second stage amplifier and gain switch

- Synchronous rectifier
- 5 ms noise filter
- DC amplifier 100 ms filter
- Signal selection (MUX)
- 16-bit analog-to-digital converter
- Digital interface

CPU/Relay and DX-LAN Cards

The CPU logic and Relay I/O cards occupy slot 5 in the card cage. The Relay I/O card rides piggyback on the CPU card, extending over the front of slot 4. The card is short enough to allow a DX-LAN interface card (P/N 044195) to be mounted behind it in slot 4.

The DX-LAN interface card is required for communication between the IC20 and PeakNet software. See Appendix B for card installation instructions.

Control Moduleware and BIOS for the IC20 reside on the CPU card. A 60-pin ribbon cable links the CPU logic to the IC20 front panel display and keypad.

The CPU logic monitors the internal power supply outputs and reports the status on the multicolored LED at the bottom of slot 4.

- Green indicates normal operation.
- Red indicates a power fault. When there is a power fault, the IC20 enters its diagnostic state and all other controls are inhibited until the fault is corrected. Turn off the power to the IC20 for a few seconds and then turn it back on. If the power fault remains, contact Dionex.

2.3 Mechanical Chassis

The mechanical chassis is housed in the pull-out drawer located behind the lower door of the IC20 enclosure. The front of the chassis contains the components described in Section 2.4. Other mechanical assemblies are located inside the chassis drawer.

Pull out the drawer only for service procedures. Before resuming routine operation, push in the drawer and tighten the lock on the lower right corner of the chassis.



CAUTION

Observe the warning label on the inside of the lower door. Arrows on the label indicate moving mechanical parts that present pinch hazards when the IC20 power is on and the mechanical drawer is open. Never operate the IC20 with the mechanical chassis drawer pulled out.

2.4 Interior Components

Figure 2-7 shows the interior components located behind the lower door of the IC20 enclosure. Figure 2-8 illustrates the eluent flow path through the pump.

The vacuum degas chamber and eluent selection valve shown in these drawings are not present in all versions of the IC20.

2.4.1 Pump Heads

Figure 5-1 illustrates the pump heads and interconnecting lines. The table below summarizes the pump head features and operating conditions.

| Piston Volume | Flow Rate (mL/min) | Maximum Operating Pressure |
|---------------|--------------------|----------------------------|
| 100 μ L | 0.04 –10.0 | 35 MPa (5000 psi) |

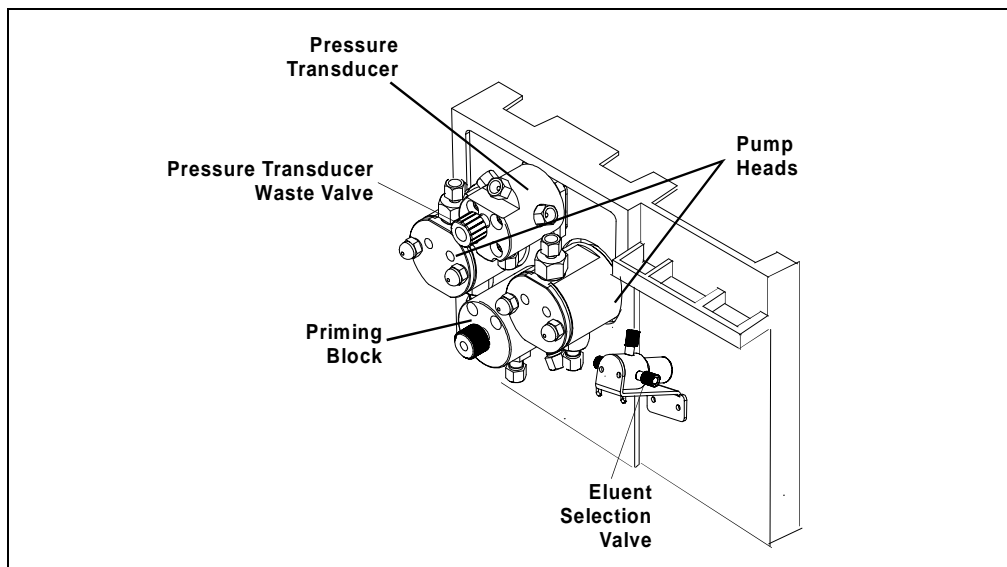

Figure 2-7. Pump Mechanical Components

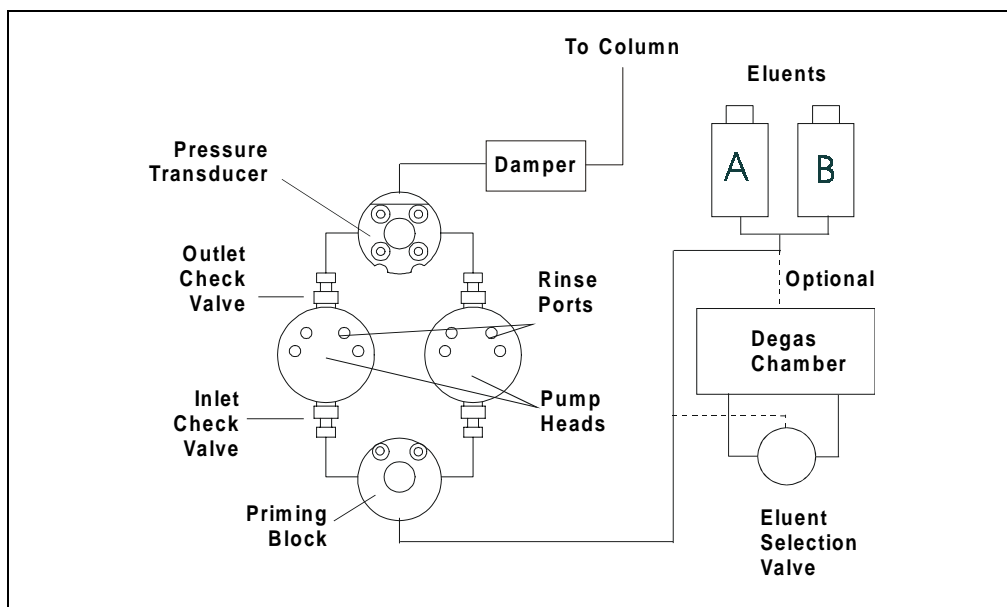

Figure 2-8. Eluent Flow Schematic

2.4.2 Pump Priming Block

The priming block “tee” directs eluent flow from the eluent selection valve into the pump heads. The priming block is also used to quickly remove air from the system.

See Section B.5 for instructions on priming the pump heads.

2.4.3 Pressure Transducer

From the priming block, the liquid stream is directed to the inlet check valves on the pump heads, through the pump heads, and through the outlet check valves to the pressure transducer.

Flow paths from the outlet check valves on the pump heads are combined in the pressure transducer. The pressure transducer measures the system pressure at this point. The interactive constant-flow/constant-pressure control program on the DSP precisely controls the pump motor speed to assure flow rate accuracy.

A waste line exits the bottom of the pressure transducer. Opening the knob on the pressure transducer diverts flow to the waste line. Opening the valve relieves system pressure and forces air out of the system.

Flow output from the pressure transducer is directed through the damper assembly and then out of the IC20 to the rest of the chromatography system (injection valve, column, detector). See Section B.4.2 for outlet line connections. Refer to the manual for a particular module for additional information.

2.5 Conductivity Cell

The flow-through conductivity cell has an active volume of about 1.0 μ L. Two 316 stainless steel electrodes are permanently sealed into the PEEK cell body. The cell constant has a nominal value of 160 cm^{-1} and is calibrated electronically. A sensor positioned slightly downstream from the electrodes senses the temperature of liquid passing through the cell. The measured value is used to provide temperature compensation.

The advanced geometry of the cell provides several benefits:

- Excellent accuracy and linearity over the working range
- Efficient sweepout and low volume for low dispersion
- Reduced sensitivity to electrode surface conditions
- Low electrode mass
- Effective temperature compensation

Dionex recommends installing the cell in an LC25 Chromatography Oven. The LC25 maintains a constant temperature, thus reducing the effects of variations in laboratory temperature.

Temperature Control and Compensation

Temperature directly affects the conductivity of a solution. As conductivity increases, the effect of temperature changes becomes more pronounced. For example, building temperature control systems can cause a regular oscillation in the baseline. This, in turn, can affect the reproducibility of an analysis.

In ion chromatography, suppressing eluent conductivity minimizes the effect of temperature variation. Temperature compensation further improves temperature stability. When the conductivity cell is installed in an LC25 Chromatography Oven, the LC25 enhances the ability of these techniques to reduce temperature effects below the detection limit.

Temperature compensation also ensures that there is no major change in the baseline or in peak heights, should it be necessary to change the LC25 operating set point. Readings will be normalized to 25 $^{\circ}\text{C}$ (77 $^{\circ}\text{F}$).

2.6 Vacuum Degas Pump Assembly (Optional)

The vacuum degas pump provides continuous on-line vacuum degassing of eluent. By default, the pump turns on for 2 minutes when the IC20 is powered up. Thereafter, it turns on for 30 seconds at 10-minute intervals. Change the cycle time and duration from the **DEGAS OPTIONS** screen (see Section C.1.7). Check the vacuum chamber pressure on the **DEGAS PUMP CALIBRATION** screen (see Section C.3.4).

The degas pump assembly consists of:

- A single-channel or dual-channel degas chamber (with degas membranes) with 17mL fluid path per channel
- A dual-stage diaphragm vacuum pump
- A solenoid valve
- An on-board vacuum sensor
- The electronics required to operate the vacuum pump
- Fittings, tubing, and other accessories

Although these components are made of inert or corrosion-resistant materials, Dionex recommends thoroughly flushing any chemicals out of the tubing with deionized water before shutting down the IC20. This helps prevent crystallization in the membrane pores.

2.7 Eluent Reservoirs

Dionex strongly recommends degassing all eluents and storing them in reservoirs pressurized with helium. This helps prevent bubbles (resulting from eluent outgassing) from forming in the eluent proportioning valves, pump heads, and detector cell.

Degassed eluents and pressurized reservoirs are especially important when combining aqueous and nonaqueous components, such as water and acetonitrile. Pressurizable reservoirs allow eluents to be stored under a specific atmosphere.

Two optional E01 Eluent Organizers (P/N 044125) can fit on top of the IC20. Each organizer can contain any two of these reservoirs:

- 1-liter glass reservoir with shatterproof plastic coating (P/N 044126)
- 2-liter glass reservoir with shatterproof plastic coating (P/N 044127)
- 1-liter plastic reservoir (P/N 044128)
- 2-liter plastic reservoir (P/N 044129)



Do not use the 2-liter plastic reservoir (P/N 044129) for off-line vacuum degassing of eluents. The reservoir was not designed for this purpose.

Refer to the *Pressurizable Reservoir Installation Instructions* for installation details.

2.8 Rear Panel

The main power receptacle (including fuses), DX-LAN connector, and service chases for cables and tubing are on the IC20 rear panel. The rear panel is shown in Figure B-1.

2.9 Functional Description

There are three ways to operate the IC20:

- In Local mode, you use the front control panel buttons and screens to set operating parameters. See Section 2.9.1 for a description of Local mode.
- In Remote mode, you use PeakNet to send operating commands from the host computer via the DX-LAN. See Section 2.9.1 for a description of Remote mode.
- With TTL input, a controlling device such as an integrator sends TTL signals to the IC20. TTL input signals can control any four of the functions listed below; all other functions must be controlled from the IC20 front panel. These functions are defined on the **TIME FUNCTION IN** screen.

PUMP/SRS ON/OFF

RUN METHOD

OFFSET

METHOD NUMBER INCRement

METHOD NUMBER DECRement

MARK Recorder

Increase RANGE X10

To select the operating mode:

Press the front panel **Local/Remote** button or follow these steps:

1. Go to either the **MAIN** or **DETAIL** screen. The operating mode field displays either **LOCAL** or **REMOTE** (see Figure 2-9).
2. Move the cursor to the operating mode field. Press **Select** ▽ or **Select** △ to toggle to the desired mode and then press **Enter** or a cursor arrow button. (For TTL input control, select Local mode.)

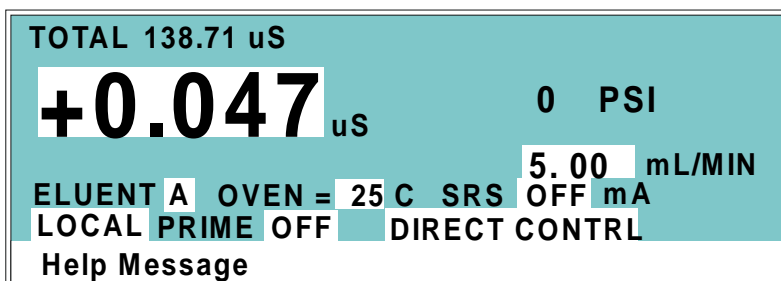

Figure 2-9. Main Screen

In addition to the operating modes, two IC20 control modes are available:

- In Direct control, commands are executed when they are entered. Because there is no time-based program, the method clock is not used and **Run Method** and **Reset** do not operate.
- In Method control, commands are executed according to the timed steps in a programmed method. See Section 2.9.2 for details about Method control.

To select the control mode:

1. Go to either the **MAIN** or **DETAIL** screen. The control mode field displays either **DIRECT CNTRL** or **METHOD** (see Figure 2-9).
2. To change the mode, move the cursor to this field. Press **Select** ▽ or **Select** △ to toggle to the desired mode and then press **Enter** or a cursor arrow button.

Both Direct and Method control are available in either the Local mode or the Remote mode. The combination of available operating modes and control modes maximizes the flexibility of IC20 operation.

The table below summarizes the different operating and control mode configurations.

| Operating/Control Mode | IC20 Operation |
|------------------------|--------------------------------------------------------------------------------------|
| Local/Direct | Commands entered from the control panel and executed immediately after being entered |
| Local/Method | Commands entered from the control panel and executed by running a programmed method |
| Remote/Direct | Commands sent from PeakNet and executed immediately when received |
| Remote/Method | Commands sent from PeakNet and executed by running a programmed method |

2.9.1 Operating Modes

Local Mode

When the IC20 is powered up, it is in Local mode (see Figure 2-9). In Local mode, the IC20 accepts operating commands from two sources:

- Direct input from the front panel keypad
- TTL inputs from a remote controller, such as an integrator

Remote Mode

In Remote mode, the IC20 accepts operating commands from the PeakNet workstation via the DX-LAN.

Remote control can be set to either normal Remote or Locked Remote:

- In normal Remote mode, all front panel buttons function except **Run Method**. Operating parameters can be changed, providing they do not interfere with a method while it is running in remote control.
- In the Locked Remote mode, all operating changes from the IC20 front panel are disabled. Locked Remote mode can be selected only from PeakNet. It can be cleared either from PeakNet or by powering down the IC20. The IC20 always powers up in the Local mode.

If the IC20 is running a method when Remote mode is selected, the computer will not interrupt the method unless an abort command is sent from the computer.

2.9.2 Method Control

In Method control, commands are executed according to the time-based steps programmed in a method. Each step specifies the flow rate to be delivered by the IC20 at a given time, the TTL and Relay outputs, and the positions of the injection and eluent selection valves.

Methods are programmed, saved, and edited from the **METHOD** screen (see Figure 2-10). See Section 3.3 for programming instructions.

| | | | | | | | | |
|---------------------|----------|------------|------------------|---------------|-------------|----------------|---|----------|
| METHOD EDIT | | 1 | SAVE TO | | 1 | RUN | | 1 |
| TEMP COMP | | 1.7 | OVEN TEMP | | 25 | SRS OFF | | |
| TIME | V | ELU | RANGE | OFFSET | MARK | FLOW | | |
| INIT | L | A | 100 uS | * | | 1.00 | > | |
| 0.00 | | | | | | | > | |
| 1.00 | L | A | 200 uS | | * | 1.01 | > | |
| 2.00 | L | A | 300 uS | * | * | 1.02 | > | |
| Help Message | | | | | | | | |

Figure 2-10. Method Screen

The following summarizes basic information about using methods:

- The IC20 can run under method control while you are entering or editing any method (including the one that is currently running).
- When saving changes to the currently running method, or switching to a different method, the method clock continues running unaffected. Only those parameter changes which affect the method after the current time will be implemented in the current run.
- The IC20 can store up to 100 separate methods (0 through 99) in memory. The actual number, which depends on the size of each method and the amount of available memory, is typically less than this.
- Methods are retained in memory even after the IC20 is powered down.
- Each method can have a maximum of 50 time-based steps. Step 1 always starts at **INIT** (initial conditions). Step 2 always starts at **TIME = 0.0**.

- After PeakNet downloads a method to the IC20, the computer sends a command to activate the method number and execute the **INIT** conditions step. If a method is running when the computer activates the new method, the old method is interrupted and the method clock is reset to the **INIT** conditions.

3 • Operation and Maintenance

3.1 Getting Ready to Run

3.1.1 Degas Eluents

Dionex strongly recommends degassing all eluents and storing them in reservoirs pressurized with filtered inert gas (see Section 3.1.3). This helps prevent bubbles caused by eluent outgassing from forming in the eluent proportioning valves, pump heads, and detector cell. Degassed eluents and pressurized reservoirs are especially important when combining aqueous and nonaqueous components (e.g., water and acetonitrile).

The IC20 with the optional vacuum degas pump assembly continuously degasses eluents.

If you have a standard IC20, manually degas eluents daily, as described below, and store them in pressurized reservoirs.

Degassing Eluents Manually

1. Prepare the eluent required for the application. Pour it into a vacuum flask and attach the flask to a vacuum pump or water aspirator.
2. Vacuum-degas the eluent for 5 to 10 minutes in addition to shaking or sonication.
3. Remove the flask from the vacuum. **Do not allow water to flow from the aspirator back into the flask.**
4. Pour the degassed eluent into a pressurizable reservoir. Be careful not to shake the eluent.
5. Install end-line filters and pressurize the reservoirs (see Section 3.1.2 and Section 3.1.3).

3.1.2 Filter Eluents

Always filter eluents with a 0.45 μ filter before use. This removes small particulates that may contaminate the pump check valves and cause erratic flow rates or loss of prime. For additional protection, end-line filters (P/N 045987) are supplied in the pressurizable reservoir ship kits for filtering during operation.

Install an end-line filter on the end of the eluent line inside the reservoir. To prevent air from being drawn through the line, make sure the end of the filter reaches the bottom of the eluent reservoir.

3.1.3 Pressurize Eluent Reservoirs

The IC20 is capable of operation with or without head pressure on the eluent reservoirs. However, vacuum degassing of the eluent is essential for optimum pump performance. Pressurization of the eluent reservoirs, if used, should be with filtered inert gas, preferably helium. Refer to the *Pressurizable Reservoir Installation Instructions* for details.

1. Verify that a regulator (P/N 051997) is installed on the gas supply line to the reservoirs.
2. Turn on the gas supply and adjust the pressure to 55 KPa (8 psi).



Never pressurize eluent reservoirs above 69 KPa (10 psi).

3.1.4 Start-Up

1. Turn on the IC20 power. The **POWER-UP** screen displays briefly and then some diagnostic tests begin running. If the tests are successfully completed, the **MAIN** screen appears after a few seconds. If one or more tests fails, the **DIAGNOSTIC TEST** screen appears, instead.
2. Set the LC25 temperature from the **MAIN** screen. Allow about 30 minutes for the LC25 to reach its upper limit of 45 °C (113 °F).
3. Set the desired flow rate. Press **Pump On** to start the pump flow.
4. Set the SRS current. The SRS power is off when the IC20 is initially powered up.
5. Check the pressure reading on the **MAIN** screen. The IC20 display updates the pressure readout once per piston stroke. The reading from one stroke to the next should be within 3% of the total pressure reading. A variation of more than 3% may indicate that the pump is not primed. Refer to Section 4.1 for conditions which can cause the pump to lose prime.

NOTE Wait at least 5 minutes (up to 30 minutes for low flow rates) after starting the pump or changing the flow rate before beginning an analysis. This delay allows the real-time electronic pulse damping circuitry to stabilize the flow rate.

3.1.5 Selecting the Pressure Limits

The high and low pressure limits automatically stop the pump in the event of a system malfunction, such as low pressure caused by a leak downstream from the pump or overpressurization due to a blockage.

When running under Direct control, enter the pressure limits from the **MAIN** or **DETAIL** screen.

When running under Method control, enter the limits from the **METHOD** screen as a part of each method. The limits are set in the **INIT** step and remain unchanged throughout an analysis. When a limit trip stops the pump, the method clock immediately stops and goes to hold. The current status of the method that was running at the time is displayed on the front panel.

1. Open the **MAIN** or **METHOD** screen and move the cursor to the **LIMIT** field.
2. Enter a low pressure limit that is 2.1 to 3.4 MPa (300 to 500 psi) below the normal system operating pressure, as indicated by the pressure display on the front panel. This setting may vary, depending on the system operating pressure. The low pressure limit will be activated after 13 pump piston strokes of fluid (1.3 mL) have been pumped through.

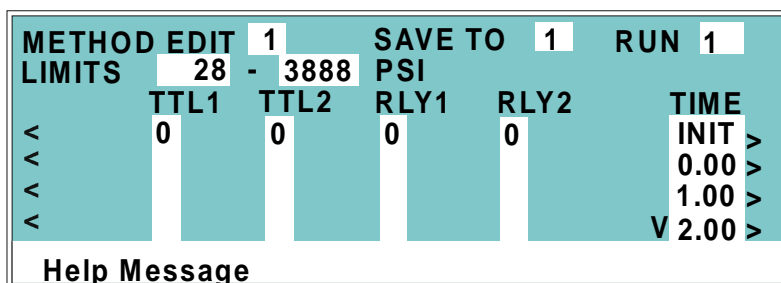

Figure 3-1. Method Screen: Setting Pressure Limits

3. Enter a high pressure limit that is 2.8 to 3.4 MPa (400 to 500 psi) above the maximum normal system operating pressure. The IC20 is equipped with a pressure limit to prevent operation above 35 MPa (5076 psi).

3.2 Running Under Direct Control

In the Direct control operating mode, commands are carried out immediately after they are entered. Changes to operating parameters remain in effect until commands changing them are issued. Because there are no time-based steps, the method clock is not used and the **Run Method** and **Reset** buttons do not operate.

To select Direct control, open the **MAIN** screen.

- If **DIRECT CNTRL** is displayed, the IC20 is already in Direct control mode and no further action is necessary.
- If **METHOD** is displayed, move the cursor to **METHOD** and press **Select** ∇ or **Select** Δ to toggle to **DIRECT CNTRL**. Press Enter or a cursor arrow button to activate the selection.

To issue commands from the IC20 keyboard or from TTL or relay input, the IC20 must be in Local control mode. Verify that the **MAIN** screen is displaying **LOCAL**. If **REMOTE** is displayed, press the **Local/Remote** button to change the mode.

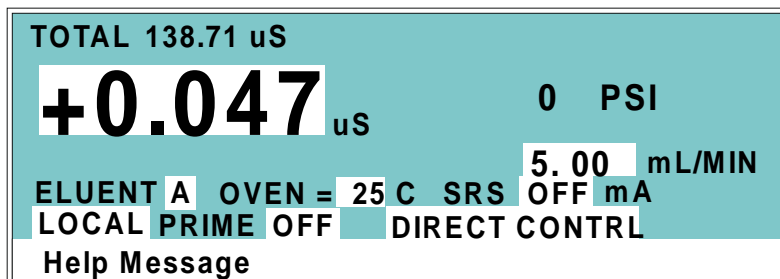

Figure 3-2. Main Screen: Direct Control Mode

3.3 Running Under Method Control

In the Method control operating mode, a series of programmed timed events, known as a *method*, controls the IC20. Methods are retained in memory even after the IC20 power is turned off.

This section explains how to create, edit, and run methods. Examples for creating a method and modifying an existing method are included.

Observe the guidelines below when entering time-based parameters on the **METHOD** screen (see Figure 3-3).

- The **TIME** field is the only field in a method step that must have an entered value. A blank field in any other step indicates no change from the value set in the previous step.
- When setting method times, allow at least 15 left-to-right piston transitions after starting the pump or changing the flow rate before beginning an analysis. This allows the pump's real-time electronic pulse damping circuitry to stabilize the flow rate. The stabilization time is 10 minutes or more for medium to fast flow rates. For slow flow rates, the stabilization time may be as long as 30 minutes. Monitor the left-to-right piston transitions from the **DSP STATUS** screen.
- In the **V** column, select the position of the injection valve (either **L** for load or **I** for inject).
- In the **ELU** column, select the eluent (either **A** or **B**).
- The **TTL** and **RLY** columns control functions in external devices that are connected to the IC20. To turn on a TTL or relay function, set the value to **1**. To turn off a function, set the value to **0**. For example, if **TTL1** is connected to the load function on an autosampler, setting **TTL1** to **1** sends the signal to the autosampler to start the load cycle. See Appendix D for details about TTL and relay control.
- In the **FLOW** column, enter the pump flow rate. The range is 0.04 to 10.0 mL/min, adjustable in increments of 0.01 mL/min.
- When a method contains more steps than can be displayed on one screen, they are scrolled off the screen. A small arrow down (v) next to the time entry at the bottom of the screen indicates there are additional steps below. A small arrow up (^) adjacent to the top time entry indicates there are additional steps

above. To view the additional steps, move the cursor to the bottom or top of the screen and then move one more line.

3.3.1 Creating a New Method

New methods can be created when the method clock is in either hold or run.

1. Open the **MAIN** screen.
2. Make sure the selected operating mode is **LOCAL**. If **REMOTE** is set, press the **Local/Remote** button.
3. Open the **METHOD** screen.
4. In the **EDIT** field, enter the number of the method to be created. This may be the number of an unused method, or else the number of an existing method that you want to edit and then save as a new method.
5. In the **TEMP COMP** field, set the temperature compensation factor to between 0 and 3%.
6. If the cell is installed in the LC25 Chromatography Oven, move the cursor to the **OVEN TEMP** field and set the temperature.
7. In the **SRS** field, turn the suppressor on or off.
8. Each method begins with two timed steps (see Figure 3-3). The first is an initial conditions step with **INIT** in the **TIME** column; the second is a time zero step with **0.00** in the **TIME** column. The parameters in the first two steps can be changed but the steps cannot be deleted. Enter the parameters for these two steps now.

| | | | |
|---------------------|-------|-----------|------------------|
| METHOD EDIT | 1 | SAVE TO | RUN |
| TEMP COMP | 1.7 | OVEN TEMP | 25 |
| TIME | V ELU | RANGE | OFFSET MARK FLOW |
| INIT | L A | 100 uS | * 1.00 > |
| 0.00 | | | >>> |
| Help Message | | | |

Figure 3-3. Method Screen: Creating a New Method

9. To enter a new step, use one of the following methods:
 - Move the cursor to the empty **TIME** field below the last step and enter the elapsed time at which to start the new step.
 - Move the cursor to any **TIME** field and press **Insert**. This adds a new step after the cursor position. Enter the elapsed time at which to start the new step.

After you press **Enter** or a cursor arrow button, timed steps are automatically organized in chronological order.

10. Enter the remainder of the parameters for the new step.
11. After entering the time-based parameters, move the cursor to the **SAVE TO** field. If this is an existing method, enter a new number and press **Enter** to save the method to the new number. If the method number was previously unused, press **Enter** to save the method.

Example: Creating a Method

Run the pump at 2.0 mL/min for 5 minutes. At 5 minutes, inject the sample and lower the flow rate to 1.0 mL/min.

1. Open the **METHOD** screen, enter a method number in the **EDIT** field (1, for example), and press **Enter**. The number in the **SAVE TO** field will change automatically to match the number of the method being edited.
 - If method 1 currently exists and you want to delete it, move the cursor to **TIME=INIT** and press **Delete** twice. This deletes the entire method.
 - If you want to retain the original method 1, enter a new, unused, method number in the **EDIT** field.
2. Move the cursor down to **INIT** and then right to **V**. If necessary, press **Select** Δ to toggle to **L** (load), and press **Enter**. Move to **FLOW** and enter 2 to set the flow rate to 2.00 mL/min.
3. Position the cursor in the blank time step below **TIME=0.00**. Enter a 5. Move to the **V** field and press **Select** Δ to toggle to **I** (inject). Move to **FLOW** and enter 1 to set the flow rate to 1.00 mL/min.
4. Move the cursor to **SAVE TO** and press **Enter** to save the method.

3.3.2 Running a Method

1. If the pump motor is off, press **Pump On** to turn on the motor.
2. Open the **MAIN** screen and, if necessary, toggle from **DIRECT CNTRL** to **METHOD** and from **REMOTE** to **LOCAL**.
3. In the **METHOD** field, enter the desired method number.

Or, to select the method number from the **METHOD** screen, move the cursor to **RUN** and enter the desired method number.

- If the method clock is already running when the method number is entered, the method starts immediately.
 - If the method clock is in hold, press **Run Method** to start the method.
4. The elapsed time on the method clock when the method begins determines where (at what step and parameters) the method begins running:
 - If the method clock is at **INIT** or time zero, the method begins running using the initial condition parameters.
 - If the method clock is greater than zero, the method begins running using the parameters specified in the step for that elapsed time. Press **Reset** to start the method at the initial conditions.

3.3.3 Controlling the Method Clock

- To start and stop the method clock, press **Run Method**.
- To reset the clock to **INIT**, press **Reset**.
- To set the clock to a specific elapsed time, enter the time in the **MIN** field on the **MAIN** screen. The method will start (or continue) running, using the method parameters specified for that time.

3.3.4 Editing a Method

You can modify, add, or delete steps and/or parameters in an existing method at any time, even while the method clock is running. If the method being edited is currently running, the changes are stored in memory and then implemented when the method is saved.

NOTE After saving changes to a method, there is no way to recall the original method. Therefore, when editing an existing method that you also wish to retain in its unmodified form, save the modified method under a new method number.

These are the basic steps for editing a method:

1. Open the **METHOD** screen. In the **EDIT** field, enter the number of the method to be modified.
2. Make changes as needed:
 - To change a field's value, position the cursor in the field and enter a new value. This automatically deletes the previous value.
 - To add a method step, move the cursor to any of the **TIME** fields and press **Insert**, or move the cursor to the empty **TIME** field below the last step and enter the elapsed time at which to start the new step. After you press **Enter** or a cursor arrow button, the new step is automatically moved to the correct chronological position. Continue entering parameters for the new step.
 - To delete a method step, move the cursor to the step to be deleted and press **Delete** twice.
3. When changes are complete, move the cursor to the **SAVE TO** field. Press **Enter** to save the changes to the current method, or enter a new method number and press **Enter**.

When changes to the currently running method are saved, they are immediately incorporated into the run and executed at the programmed time. However, if a change is made to an event after it has been executed, it cannot be incorporated into the current run. To run the new version of the method, press **Reset** to restart the method at the **INITIAL** conditions.

3.3.5 Deleting a Method

To delete an entire method, move the cursor on the **METHOD** screen to the **INIT** step, then press **Delete** twice.

3.3.6 Changing the Running Method

To switch from the method currently running to a different method, enter the new method number in the **RUN** field on the **METHOD** screen and press **Enter**. The new method begins running using the parameters specified in the step for the current elapsed time. Press **Reset** to start the method at the **INIT**ial conditions.

3.4 Optimizing Temperature Compensation

The IC20 built-in temperature compensation stabilizes conductivity readings by correcting for changes in ambient temperature that occur during a run.

Housing the conductivity cell in the LC25 Chromatography Oven ensures that there is no more than a minor temperature variation in liquid reaching the cell, so the **TEMP COMP** setting on the **DETAIL** screen can remain at 1.7% per °C.

Many users are able to stay at a single operating temperature. For optimal accuracy, calibrate the cell at this temperature (see Section C.3.7), using the proper temperature coefficient setting. If the temperature is later reset, the IC20 temperature compensation will normalize conductivity measurements to 25 °C (77 °F) to prevent a major upset in system calibration. If the LC25 set point is changed, recalibrate the cell.

If temperature-induced baseline cycling occurs, it is probably caused by another component of the chromatography system. If the variation increases as the eluent reservoir empties, move the reservoir to a more temperature-stable environment and/or wrap the reservoir in thermal insulation.

3.5 Shutdown

- Rinse the pump pistons after daily operation to prevent build-up of salt crystals or other contaminants that can damage the piston seal (see Section 3.6.1).
- Turn off the main power.
- If the IC20 will not be used for three days or more, flush the system with deionized water to prevent contaminants from building up.
- If the shutdown is for more than three days, reduce the pressure on the eluent reservoir(s) to about 21 KPa (3 psi).

3.6 Routine Maintenance

This section describes routine maintenance procedures to be performed by the user. Any other maintenance procedures must be performed by qualified Dionex personnel.

3.6.1 Daily Maintenance

- After operation with a combination of eluents containing both salt or base and solvent, rinse the piston frequently or continuously. Eluent tends to crystallize as the solvent evaporates. These crystals can abrade the piston, causing the main seal to leak. Rinse the piston before and after daily operation, as described below.
 1. Open the lower door of the IC20 and locate the rinse ports on the front of the pump heads (see Figure 3-4).
 2. Install the two rinse waste tubes (P/N 054418) located in the IC20 Ship Kit onto the heads. Place the end of each tube into a waste container.
 3. Attach a small syringe (P/N 054578) containing 5 to 10 mL of deionized water to one of the female luer fittings.
 4. Inject deionized water into the fitting. Water will flow through the first head, through the short connecting tubing to rinse the second head, and out to waste.
 5. Remove the syringe and dispose of the waste water. Close the door to the mechanical chassis.

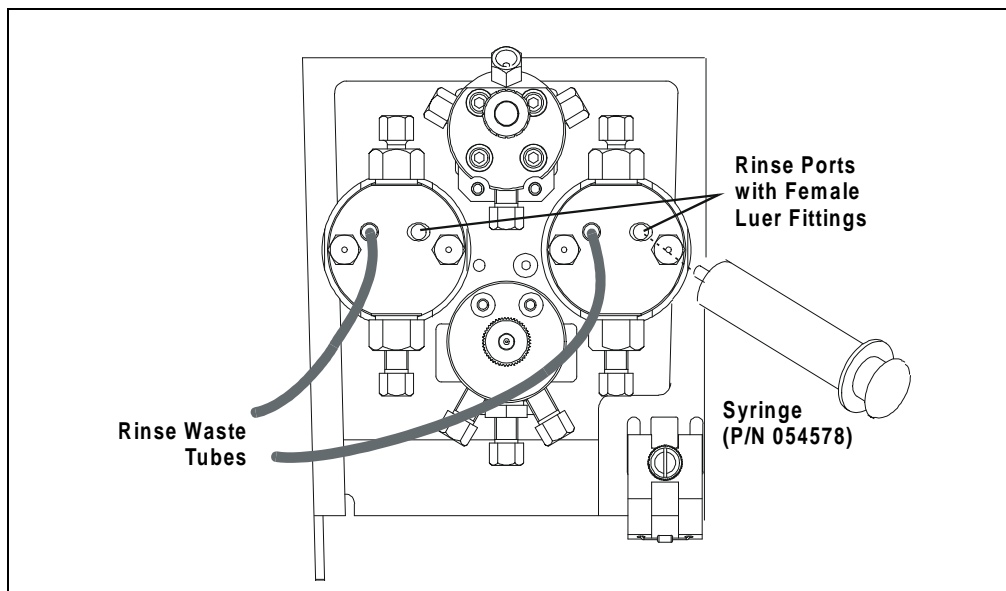

Figure 3-4. Rinsing the Pump Heads

- All components of the optional vacuum degas assembly are made of inert materials or corrosion-resistant materials. To avoid crystallization in the membrane pores, thoroughly flush any chemicals out of the vacuum degas chamber(s) and tubing with deionized water after each use.
- Check the entire mechanical chassis for leaks from the rinse ports, the vacuum degas chamber(s), and the eluent reservoir (see Figure 3-5). Tighten or replace any leaking fittings. Wipe up liquid spills and rinse dried reagents off pump components with deionized water.

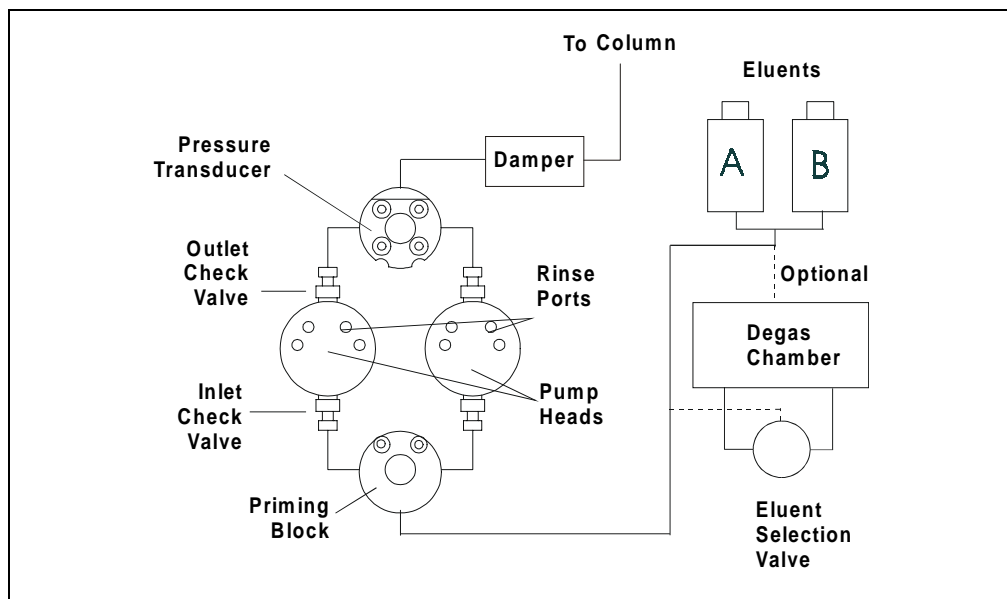

Figure 3-5. Eluent Flow Schematic

3.6.2 Periodic Maintenance

Replace both the primary piston seals and rinse seals in each pump head approximately every 6 months (see Section 5.2). The seals may need to be replaced more often if you operate the pump continuously, or if you routinely run at high pressure or high flow rates. A drop of eluent trapped in the end of the drain tubes is normal, but eluent flowing from the tubing indicates a leak.

IMPORTANT

The seals may need to be replaced more often if you operate the pump continuously, or if you routinely run at high pressure or high flow rates.

4 • Troubleshooting

This chapter is a guide to troubleshooting routine problems that may occur while operating the IC20 Ion Chromatograph. To use this guide, turn to the section that best describes the operating problem. There, the possible causes of the problem are listed in order of probability, along with the recommended courses of action.

If you are unable to eliminate a problem, contact Dionex for help. In the U.S., call Dionex Technical Support at 1-800-346-6390. Outside the U.S., call the nearest Dionex office.

4.1 Left-Right Pump Head Pressure Fluctuations

The IC20 display updates the pressure readout once per piston stroke. A variation of more than 3% of the total pressure reading from one stroke to the next indicates a problem.

- **Pump out of prime; there is no eluent**
 1. Refill the eluent reservoir. Verify that the eluent line extends to the bottom of the reservoir.
 2. Prime the pump (see Section B.5).
- **Pump out of prime; eluent is improperly degassed**

If the IC20 does not include the optional degas pump assembly, degas the eluents manually (see Section 3.1.1) and then prime the pump (see Section B.5).
- **Pump is out of prime; liquid line leak**

Check for liquid leaks (see Section 4.4). Tighten fittings or replace lines.
- **Pump is out of prime; end-line filter is dirty or clogged**
 1. Replace the filter (P/N 045987).
 2. Prime the pump (see Section B.5).
- **Pump is out of prime; blockages in inlet tubing.**
 1. Check for kinked or clogged tubing and replace.

2. Prime the pump (see Section B.5).
- **Priming did not eliminate excessive pressure fluctuations; dirty or defective piston seal or check valves**
 1. Follow these steps to isolate the cause:
 - a. If leaks are seen from the piston rinse tubes, replace the piston seals (see Section 5.2).
 - b. If no leaks are seen, replace the check valves (see Section 5.1). Dirty or defective check valves can be caused by impurities in the eluents. Install end-line filters (P/N 045987) to prevent this.



CAUTION

Observe the warning label on the inside of the mechanical chassis door. The arrows on the label indicate moving mechanical parts that present pinch hazards when the pump is on and the drawer is open. Do not touch any parts within the mechanical chassis while the pump is on.

- c. Slide open the mechanical chassis drawer. If a piston does not move when there is pump flow, examine it for breakage and replace if necessary (see Section 5.3). If a piston moves, examine it for scratches and replace if necessary (see Section 5.3). If a piston moves slightly and then breaks contact with the rocker arm follower (the cylinder holding the piston in place as it moves in and out of the pump head assembly), replace the piston seal (see Section 5.2).
- d. Push the mechanical chassis drawer back in place and make sure the cables are not pinched. Retighten the drawer lock and turn on the main power switch.

4.2 Pump Will Not Start

- **Flow rate is set to zero**

Select a flow rate from 0.04 to 10.0 mL/min.

- **While being primed, pump starts briefly, then stops because of high pressure limit**

1. Check the high pressure limit setting (see Section 3.1.5).
2. Replace any crimped or blocked tubing downstream from the pressure transducer. If there is none, go on to Step 3.
3. Open the pressure transducer waste valve by turning the knob counterclockwise about two turns (see Figure 2-7). Check the pressure reading; if it is above 97 KPa (14 psi), recalibrate the pressure transducer (see Section C.3.6).
4. Select a lower flow rate or, when safe to do so, increase the high pressure limit.

4.3 Pump Stops

- **Method or other remote input instructed the pump to stop**

Check the display screen for error messages. If no error message is displayed, the pump was probably instructed to stop by the method, computer, or other remote signal source.

- **Electrical cables improperly installed**

1. Place the IC20 in **LOCAL** mode, **DIRECT CONTROL**. Press **Pump On** to start the pump.
2. If a non-zero flow rate is displayed and the **Pump On** LED is illuminated, verify that the electrical cables in the mechanical chassis are properly installed.
 - a. Turn off the main power switch.
 - b. Using a 7-mm open-end wrench or your fingers, loosen the mechanical chassis drawer lock on the lower right side of the chassis (see the label on the inside of the lower door).
 - c. Pull out the drawer a few inches.

- d. Verify that all cables are seated properly in the connectors on the distribution card located on the top of the mechanical chassis.
 - e. Push the mechanical chassis drawer back in place, making sure the cables are not pinched. Retighten the drawer lock. Turn on the power.
- **Low pressure limit was tripped. The following message is displayed:**

Low Pressure Limit Violation

1. Check the low pressure limit setting (see Section 3.1.5).
2. If the eluent reservoir is empty, refill it. Prime the pump before resuming operation (see Section B.5).
3. Make sure the waste valve on the pressure transducer is closed by turning the knob on the pressure transducer housing clockwise (see Figure 2-7).



Overtightening the pressure transducer waste valve may damage the valve and the pressure transducer housing.

4. Make sure there are no liquid leaks in the flow system.
5. Place the IC20 in **LOCAL** mode, **DIRECT CONTROL**. Press **Pump On** to start the pump. Verify that the pistons are moving and that you can hear the pump.

If there is no sound from the pump, check the LED on the CPU card inside the door to the electronics chassis (see Figure 2-6). A red LED indicates a defective power supply. The power supply (P/N 046440) must be replaced by qualified personnel. Contact Dionex.

6. With the pump running, open the **MAIN** screen and note whether the left-right pressure varies by more than 3% between strokes. If it does, refer to Section 4.1. If it does not, either increase the flow rate or reduce the low pressure limit setting and then resume operation.

- **High pressure limit was tripped. The following message is displayed:**

High Pressure Limit Violation

1. Check the high pressure limit setting (see Section 3.1.5).
2. Isolate segments of the flow path to determine the source of the high pressure. First, remove the pump inlet tubing from the injection valve. Turn on the pump and record the pressure reading. Add in each segment of the remaining flow path until the source of the high pressure is determined. Replace any tubing, fittings, and components necessary to resume standard operating pressure. If the source of the high pressure is the column, refer to the column manual for troubleshooting procedures. Replacement may be required.
3. Open the pressure transducer waste valve by turning the knob counterclockwise about two turns (see Figure 2-7). If the pressure reading is above 97 KPa (14 psi), recalibrate the pressure transducer (see Section C.3.6).

- **An error message beginning with “DSP” displays:**

There are several messages related to DSP (Digital Signal Processor) errors; for example, “DSP communication fails” and “DSP does not acknowledge.” These messages are all treated similarly.

1. Turn off the main power to the IC20. Verify that the DSP card is properly installed in slot 1 of the electronics chassis card cage (see Figure 2-6).
2. Turn on the main power to the IC20. If the DSP error message reappears, notify Dionex. The power supply (P/N 046440), DSP card (P/N 045369), or CPU card (P/N 046340) may need replacing.

IMPORTANT

Do not remove any of the electronic cards from the IC20. There are no user-serviceable components on the cards. Servicing must be performed by qualified Dionex personnel and appropriate electrostatic discharge (ESD) handling procedures must be followed.



The CPU card contains a lithium battery. If the CPU card is replaced, dispose of the used battery according to the manufacturer's instructions

- **The following error message displays:**

| |
|-------------------|
| Motor Drive Fails |
|-------------------|

If the pump motor is in a runaway condition, the motor automatically shuts off and the above error message is displayed. Contact Dionex.

- **The following error message displays:**

| |
|-------------------------|
| Encoder Index Not Found |
|-------------------------|

1. Turn off the main power to the IC20. Verify that the cables connected to the DSP card in the electronics chassis (see Figure 2-6) are seated properly.
2. Turn on the main power to the IC20. If the error message reappears, notify Dionex.

4.4 Liquid Leaks/Leak Alarm

- **Leaks from the front rinse ports or rear of the pump head indicate a defective piston seal**

Replace the piston seal and rinse seal (see Section 5.2).

- **Leaks from any connection between the eluent reservoir and the pump heads indicates an eluent leak (see Figure 3-5)**

Tighten the fitting connections just enough to stop the leak.

- **Pressure transducer leaks**

Inspect the pressure transducer. If the leak is from the waste valve, replace the waste valve O-ring (see Section 5.4). If the leak is from the rear of the transducer, contact Dionex.

- **Priming valve leaks**

Tighten any leaking fittings just enough to stop the leak. Replace any defective tubing assemblies. If this does not stop the leak, the priming block assembly (P/N 054086) must be replaced by qualified personnel. Contact Dionex for assistance.

- **Interior mechanical chassis leaks**

Inspect the chassis for leaks. Tighten any leaking fittings and replace any damaged parts.

4.5 High-Pitched Noise From Pump Motor (or Motor Racing)

- **DSP (digital signal processing) card current limit has been exceeded**

A built-in current limiter on the card protects the motor and motor drive. Check the three small LEDs located in the upper left corner of the DSP card bulkhead. (The DSP card is in slot 1 of the electronics chassis card cage.) If the bottom LED is flashing in time with the pump strokes, the current limiter is being activated. As the pump motor ages, it becomes less efficient and the current limit is activated more frequently. Activating the current limit is harmless; however, if it occurs frequently, even at low speeds and/or pressures, the bottom plate assembly (P/N 045670) needs to be replaced by qualified personnel. Call Dionex for assistance.

- **Pressure servo oscillation**

Open the **DSP STATUS** screen and verify that the correct pump head volume and head material are selected. If the settings are correct but the problem persists, notify Dionex.

- **Out of prime**

Reprime the pump (see Section B.5).

4.6 Vacuum Degas Pump Does Not Run

- **DEGAS OPTIONS screen settings incorrect**

Open the **DEGAS OPTIONS** screen (press **Menu, 4, 4**). If the **DEGAS PUMP** field is set to **ALWAYS OFF**, select **BY SETTING** and enter the desired cycle duration and frequency times. By default, the degas pump runs for 2 minutes when the IC20 is powered up. Thereafter, it runs every 10 minutes for 30 seconds.

- **Electrical cables improperly installed**

The vacuum degas pump should turn on and run for about 45 seconds. If it does not run, verify that the cables connected to the pump in the electronics chassis and in the mechanical chassis are properly connected.

1. Turn off the main power switch.
2. Using a 7-mm open-end wrench or your fingers, loosen the mechanical chassis drawer lock on the lower right side of the chassis (see the label on the inside of the lower door). Pull out the drawer a few inches.
3. Check that all cables are seated properly in the connectors on the distribution card located on the top of the mechanical chassis.
4. If the connections are correct, the distribution card may need to be replaced. Call Dionex for assistance.
5. Push the mechanical chassis drawer back in place, making sure the cables are not pinched. Retighten the drawer lock.

4.7 Vacuum Degas Pump Calibration Fails

- At the end of the degas calibration, the **DEGAS READING** value is less than **13000 counts** and one of the following error message appears:

```
Degas vacuum pump is not present or degas  
circuitry is malfunctioning.
```

```
Vacuum Degas Fails
```

Verify that the cable to the vacuum degas pump is connected to the distribution card in the mechanical chassis.

1. Turn off the main power switch.
2. Use a 7-mm open-end wrench or your fingers to loosen the mechanical chassis drawer lock on the lower right side of the chassis (see the label on the inside of the lower door). Pull the drawer out a few inches.
3. The distribution card is on the top of the mechanical chassis. Labels printed on the card identify the various cables plugged into it. The connector for the vacuum degas pump, labeled **VAC PUMP**, is near the right rear corner of the card. Check the connection.
4. Push the mechanical chassis drawer back in place, making sure the cables are not pinched. Retighten the drawer lock. Turn on the main power switch.
5. Retry the calibration. If the message reappears, notify Dionex.

4.8 Vacuum Degas Pump Low Vacuum

The IC20 monitors the degas vacuum once a minute. If the reading is 2000 counts or more below the degas calibration value, the following message is displayed:

```
LOW VACUUM ALARM!!  
Check DEGAS OPTIONS settings or refer to  
operator's manual
```

Open the **DEGAS OPTIONS** screen (press **Menu, 4, 4**). Try increasing the **CYCLE DURATION** time and/or decreasing the **TIME BETWEEN CYCLES**. If this does not solve the problem, contact Dionex.

4.9 Inoperative Relay Control Function

- **Incorrectly installed cables**

Make sure the cables between the appropriate relay function and the input or output unit are properly connected (see Appendix D).

- **Method programming error**

Refer to Chapter 2 and Appendix C.

- **When attempting to set TTL2, the following message appears:**

```
TTL2 is set to indicate FLOW/NO FLOW.
```

The **TTL2 OUTPUT USAGE** field on the **PUMP OPTIONS** screen is currently set to signal when pump flow stops (**0 FLOW**). This setting is used to control the power to a Self-Regenerating Suppressor (SRS). To use TTL2 for another function, open the **PUMP OPTIONS** screen and set the **TTL2 OUTPUT USAGE** field to **NORMAL**.

4.10 Poor Chromatographic Reproducibility

- **Liquid lines incompletely flushed after an eluent change**

Attach a syringe to the priming block and draw at least 2.5 mL (20 mL if the vacuum degas pump is installed) of the new eluent through the liquid lines before beginning operation.

- **Leaking piston seal**

Check for liquid leaks at the rinse ports in the front of the pump heads (see Figure 3-5). Replace the piston seal on any head with a leak (see Section 5.2).

- **Equilibration time too short**

Wait at least 10 minutes after starting the pump or changing the flow rate before beginning an analysis. This allows the pump's real-time electronic pulse damping circuitry to stabilize the flow rate.

4.11 No Detector Response

- **Cell is off**

Turn on the cell (from the **MAIN** screen).

- **Analog output range set too high; although the display indicates a response, no recorder response observed**

Select a more sensitive analog output range.

- **Wrong full-scale output (or no full-scale output) selected**

Select 0.01, 0.10, or 1 volt full-scale.

- **No flow from pump**

Check the pressure reading on the pump to verify that the pump is on.

- **Detector offset out of range**

Press **Offset** on the IC20 front panel.

4.12 Low Detector Output

- **Analog output range set too high; although the display indicates a response, no recorder response observed**

Select a more sensitive analog output range.

- **Insufficient sample injected**

Increase the injection size or concentration.

- **Cell out of calibration**

Recalibrate the cell (see Section 5.8).

4.13 High Detector Output

- **Auto offset not activated recently**

Press **Offset** on the IC20 front panel before making an injection.

- **Background not suppressed by SRS**

Check the SRS regenerant out line for bubbles. If there are no bubbles, the suppressor may not be functioning properly. Refer to the SRS manual for troubleshooting guidance.

4.14 Noisy or Drifting Baseline

- **Flow system leak ahead of cell; erratic baseline**

Check all fittings and liquid lines for leaks. Tighten or, if necessary, replace all liquid line connections. If the connections are made with ferrule fittings, first refer to *Installation of Dionex Ferrule Fittings* for tightening requirements.

- **Pump not properly primed**

Prime the pump (see Section B.5).

- **Rapid changes in ambient temperature**

Redirect heating and air conditioning vents away from the cell.

- **Insufficient system equilibration following any changes to operating parameters; especially apparent when operating at high sensitivities**

Allow longer system equilibration before beginning operation.

- **Air trapped in cell; excessive pulses in baseline**

Remove the trapped air (see Section 5.7). To prevent air from becoming trapped in the cell again, increase backpressure on the cell by reducing the inner diameter of the tubing installed after the cell and before the SRS.

- **Inappropriate SRS operating conditions**

Check the SRS manual for the correct operating conditions.

- **Temperature compensation setting not optimized**

Optimize the selected setting.

4.15 Conductivity Inaccurate

- **Cell constant reported on CALIBRATE CONDUCTIVITY CELL screen after cell calibration is not 130 to 190 μS**

The LC25 has not reached its set point temperature. Set the intended operating temperature. The “Not Ready” message will be displayed until the cell reaches its set point. The entire enclosure will take longer to reach the set temperature, depending on the set point and the ambient temperature.

Make sure the selected temperature compensation setting is 1.7%/°C. Except at 25 °C, an incorrect temperature compensation setting can cause an incorrect reading.

The 1 mM KCl calibration solution is spoiled, or there was a mixing error. Remake the solution.

The electrodes are fouled by grease, precipitate, etc. Using a syringe, flush 5 mL of 3 M HNO₃ through the conductivity cell. Rinse thoroughly with water. Recalibrate the cell with 1 mM KCl.

The cause is internal leaks, broken or shorted cell or sensor wires. Replace the cell.

- **Cell temperature readout deviates by more than 2°C from LC25 set temperature**

This indicates a serious cell or LC25 sensor problem. Call Dionex for assistance.

4.16 Faulty DX-LAN Communication

- **DX-LAN interface incorrectly installed**
 1. Make sure a BNC tee connector (P/N 921914) is attached to the DX-LAN connector on the IC20 rear panel (see Figure B-2).
 2. Connect the DX-LAN cable (P/N 960404) to one side of the BNC tee. The DX-LAN cable must be RG-58U or RG-58AU. **Do not substitute cables; they will interfere with signals on the DX-LAN.**
 3. Verify that the tee connectors at both ends of the network are capped with terminator plugs (P/N 921034) as described in Section B.2.3. The plugs are shipped with PeakNet software.

NOTE The IC20 electronics components are not customer-serviceable. All electronics-related repair procedures must be performed by Dionex personnel.



The CPU card contains a lithium battery. If the CPU card is replaced, dispose of the used battery according to the manufacturer's instructions.

This chapter describes routine service procedures for the IC20 mechanical components. Any procedure not described here must be performed by Dionex personnel.

Before replacing any part, check the troubleshooting information in Chapter 4 to isolate the source of the problem.

Substituting non-Dionex parts may impair IC20 performance, thereby voiding the product warranty. Refer to the warranty statement in the Dionex Terms and Conditions for more information.

5.1 Cleaning and Replacing the Check Valves

A dirty check valve causes erratic flow rates and pressures. It may also cause the pump to lose prime and/or be difficult to reprime.

1. Turn off the main power switch to prevent the IC20 from starting inadvertently.
2. Release the pressure from the eluent reservoir.
3. Disconnect the tube fittings from the inlet and outlet check valve housings (see Figure 5-1).
4. Use a 12-mm wrench to loosen both check valve housings. Remove the check valve housing from the pump head. Carefully remove the check valve cartridge from the housing.
5. Place the check valve housings and cartridges in a beaker with methanol, and sonicate or agitate for several minutes.

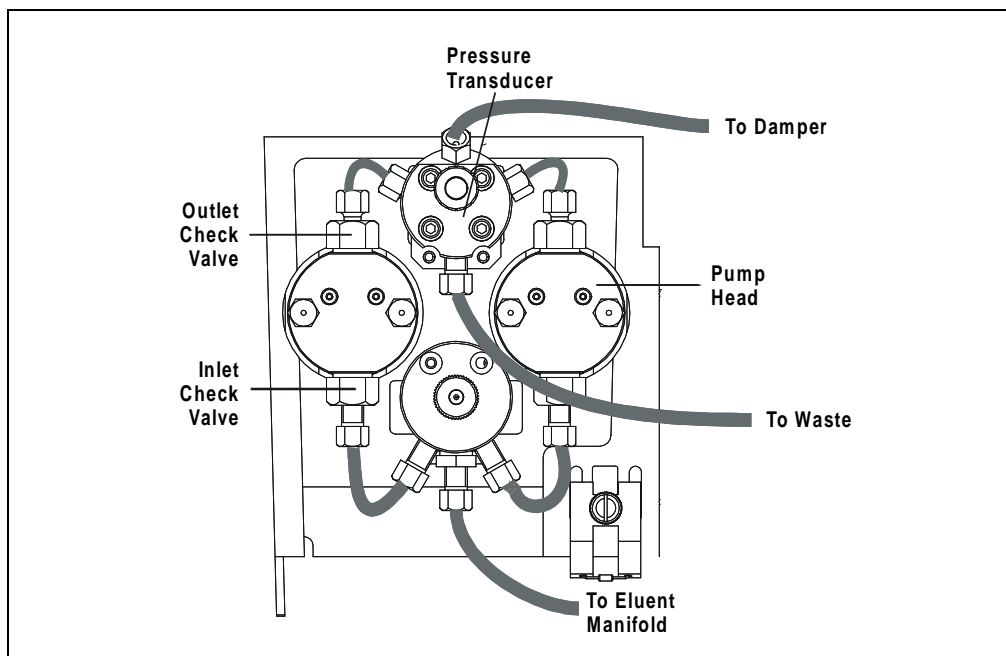

Figure 5-1. Pump Heads and Liquid Lines

6. Rinse each check valve housing and cartridge thoroughly with filtered deionized water.
7. The inlet check valve assembly housing has a 1/4-28 port. Replace the cartridge in the inlet check valve housing; the double-hole end of the cartridge should be visible. The outlet check valve assembly housing has a 10-32 port. Replace the cartridge in the outlet check valve housing; the single-hole end of the cartridge should be visible. Liquid flows through the check valve in the large single hole and out the small double holes. If the cartridge is not oriented correctly, the pump will not operate properly.
8. Reinstall the check valves. Make sure that the inlet check valve is installed on the bottom of the head and that the outlet check valve is installed on the top of the head. Tighten only enough to seat (25 in-lb torque). Tighten a little more only if it leaks.



Overtightening may damage the pump head and the check valve housing and crush the check valve seats.

9. Reconnect the liquid lines. Turn on the main power switch.
10. Prime the pump (see Section B.5). If the pump will not prime and all other possible causes of the problem have been eliminated, replace the check valve cartridge (P/N 047747).
11. After replacing check valve cartridge, open the **ELAPSED TIME** screen. Move the cursor to the **VALVES IN USE** field and press **Enter** to reset the field to 0 cycles.

5.2 Piston Seal Replacement

A damaged seal allows leakage past the piston and then through the rinse ports in the front of the pump heads. The pump may be difficult to prime, flow rates will be unstable, and baseline noise may be observed.

1. Turn off the main power switch.
2. Disconnect the tube fittings from the pressure transducer and the inlet check valve (see Figure 5-1).
3. Remove the two nuts from the pump head.
4. Carefully disengage the head from the piston by pulling the head straight off and away from its mounting guides.



Lateral motion while disengaging the head from the piston may break the piston.

5. Place the head (front end down) on a clean work surface and lift off the backup washer to expose the piston guide (see Figure 5-2 and Figure 5-3).
6. The pistons are captured by a magnetic retention system and do not come off as part of the pump head assembly. After removing the pump head, apply just enough lateral force to overcome the magnetic field and release the pistons.
7. To remove the piston guide and seal:
 - a. Fill the head cavity with deionized water by injecting through either the piston opening or the inlet check valve.
 - b. Reinsert the piston approximately 1/8 inch into the seal Figure 5-3.
 - c. Install a 10-32 fitting plug (P/N 042772) on the outlet check valve and a 1/4-28 fitting plug (P/N 037628) on the inlet check valve. Tighten the plugs.
 - d. Push the piston into the head. This action will hydraulically unseat the seal and piston guide from the head. Remove the piston and pull off the guide and seal.
 - e. If the piston guide and seal do not come out, make sure the 10-32 plug is tight. Then, add more water and repeat Steps b and d.
 - f. Remove the 10-32 fitting plug.

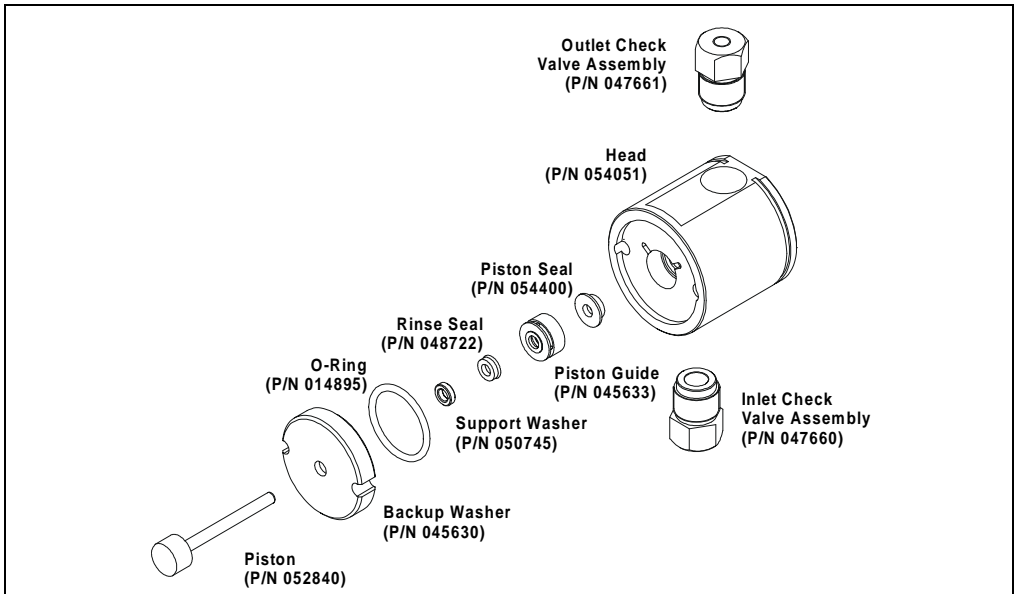

Figure 5-2. Pump Head Assembly

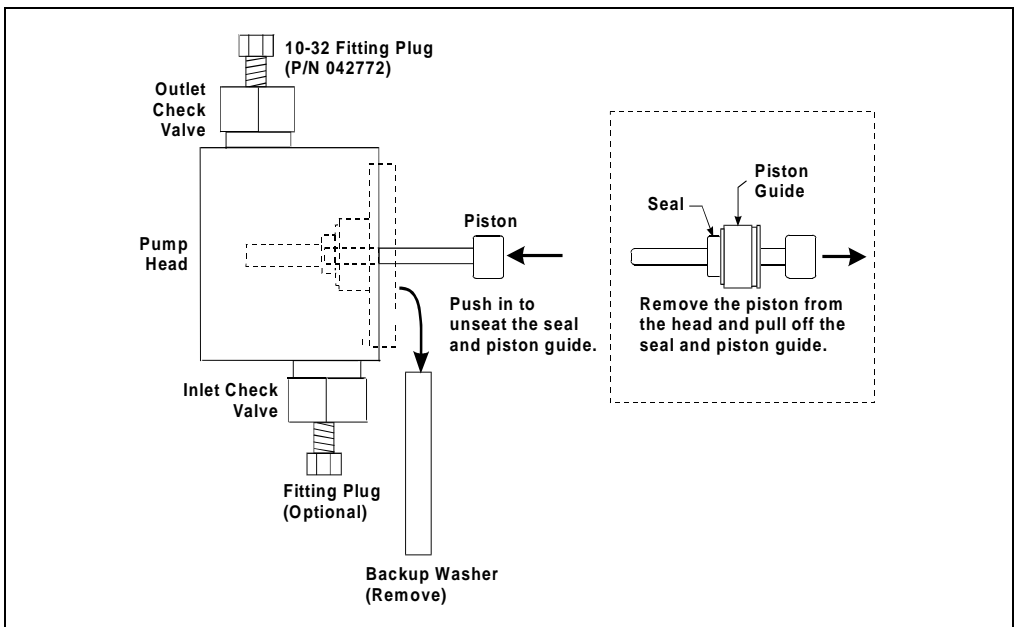

Figure 5-3. Removing the Piston Seal

8. To install the new seal and reinstall the piston guide:
 - a. Push the piston through the piston guide and the new seal. Then insert the piston, piston guide, and seal into the pump head just until the seal makes contact with the bottom of the counterbore (see Figure 5-4, View A).
 - b. Hold the piston guide and seal in place and remove the piston from the head (see Figure 5-4, View B).
 - c. Seat the seal by pushing the piston guide into the head until it is flush with the head.

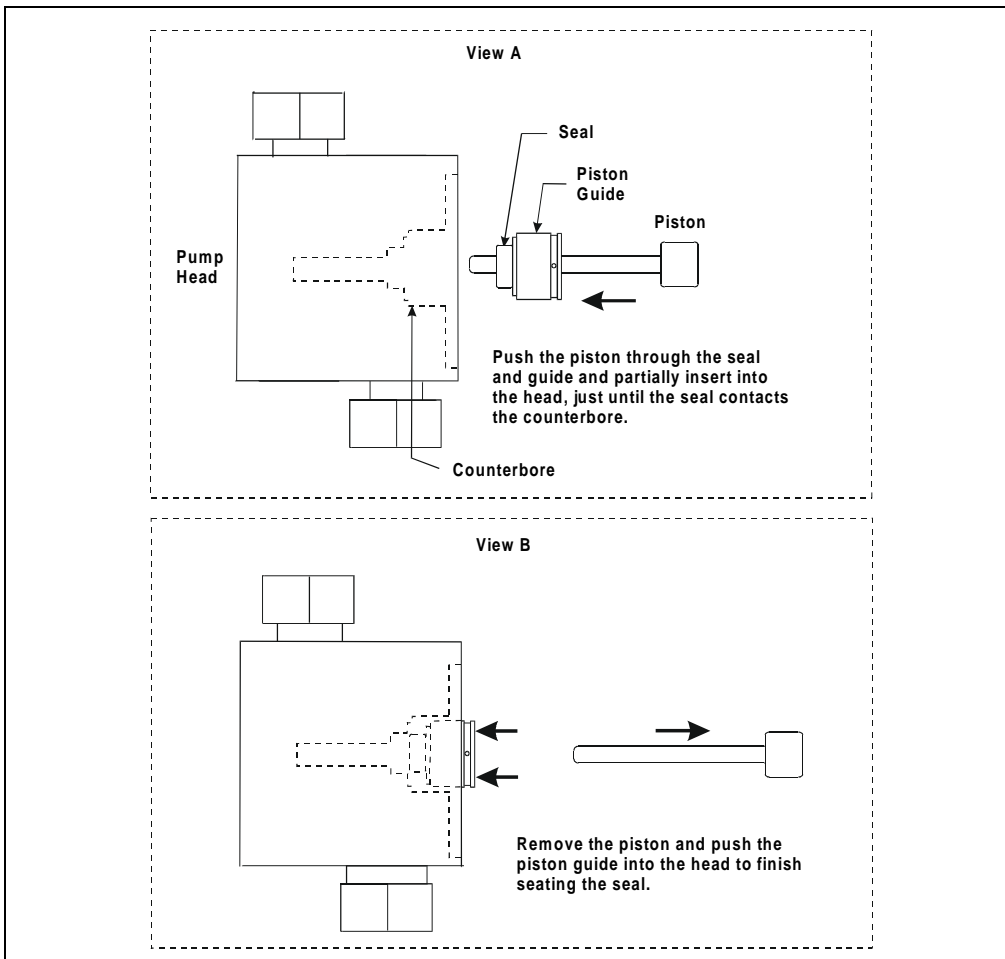

Figure 5-4. Installing the Piston Seal

9. Dionex recommends reinstalling the head and piston as a single assembly so that the piston centers itself. To do this, first press the backup washer into the head until it is flush with the indented surface of the head. Then, insert the piston *halfway* into the head. This ensures that the magnet in the follower picks up the piston. (The follower is the cylinder that holds the piston in place as it moves in and out of the pump head assembly.) Reinstall the head and piston assembly, using a wrench to tighten the nuts evenly (12 in-lb torque).
10. Reconnect the liquid line to the inlet check valve.
11. Reconnect the tube fittings to the pressure transducer.
12. Turn on the main power switch.
13. Open the **ELAPSED TIME** screen (choice 2 on the **DIAGNOSTIC MENU**). Press **Enter** to reset the **SEALS IN USE** field to 0 cycles. The pump is ready for normal operation.

5.3 Pump Piston Replacement

Continued leaking through the rinse ports after replacing the piston seal (assuming the head is tight) indicates a dirty, scratched, or broken piston.

1. Turn off the main power switch.
2. Disconnect the tube fittings from the pressure transducer and the inlet check valve (see Figure 5-1).
3. Remove the two acorn nuts from the pump head.



CAUTION

Lateral motion while disengaging the head from the piston may break the piston.

4. Slowly pull the head and allow it to separate from the housing. Carefully disengage the head from the piston by pulling the head straight off and away from the mounting guides.
5. The pistons are captured by a magnetic retention system and do not come off as part of the pump head assembly. After removing the pump head, apply just enough lateral force to overcome the magnetic field and release the pistons.
6. If the piston is broken, replace the piston, piston seal, and rinse seal.
7. Dionex recommends reinstalling the head and piston as a single assembly so that the piston centers itself. First, press the backup washer into the head until it is flush with the indented surface of the head. Then, insert the piston *halfway* into the head. This ensures that the magnet in the follower picks up the piston. (The follower is the cylinder that holds the piston in place as it moves in and out of the pump head assembly.) Reinstall the head and piston, using a wrench to tighten the nuts evenly (12 in-lb torque).
8. Reconnect the liquid line to the inlet check valve.
9. Reconnect the tube fittings to the pressure transducer.
10. Turn on the main power switch and prime the pump (see Section B.5).

5.4 Pressure Transducer Waste Valve O-Ring Replacement

A damaged O-ring causes leakage around the base of the pressure transducer waste valve knob.

1. Turn off the main power switch.
2. Remove the valve from the pressure transducer housing by turning the knob counterclockwise until it comes loose from the housing.
3. Remove the O-ring (see Figure 5-5).
4. Carefully slide a new O-ring (P/N 046434) over the end of the valve and push it into the groove.
5. Reinstall the valve in the housing, turning the knob clockwise until the valve is seated.



Do not overtighten the waste valve.

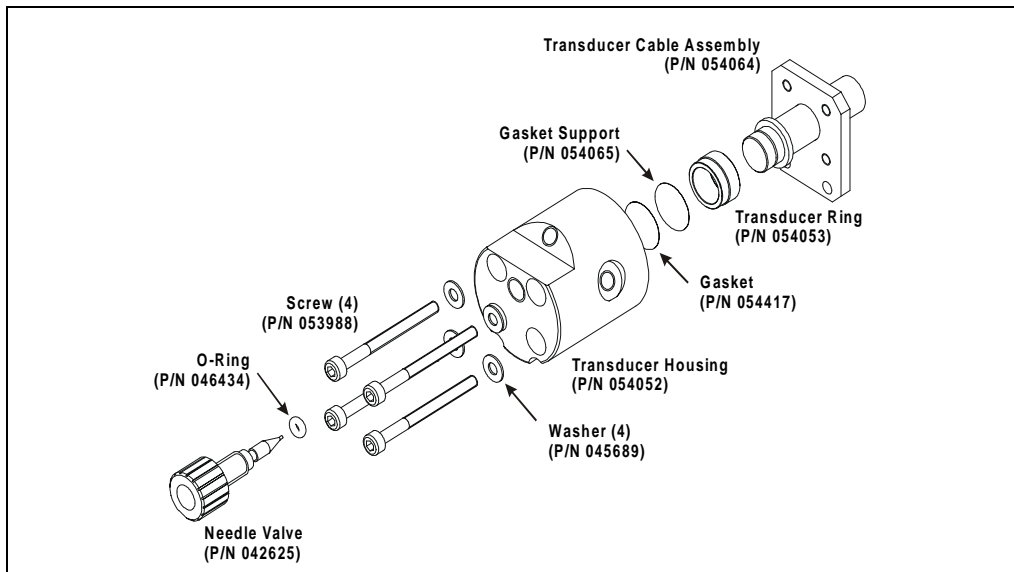

Figure 5-5. Pressure Transducer Assembly

5.5 Changing Main Power Fuses

1. Turn off the main power switch. (This prevents the IC20 from starting inadvertently.)



HIGH VOLTAGE—Disconnect the main power cord from its source and from the IC20 rear panel.

2. The fuse holder is part of the main power receptacle on the rear panel of the IC20 (see Figure 5-6). A recessed lock is located on each side of the fuse holder. Using a small screwdriver, push each lock toward the center to release it. The fuse holder pops out approximately 0.16 cm /16 in) when the locks release. When both locks are released, pull the fuse holder straight out of its compartment.
3. The holder contains two fuses. Replace these with the new IEC127 fast-blow fuses rated 3.15 amps (P/N 954745). Dionex recommends replacing both fuses even though only one is open.
4. Reinsert the fuse holder into its compartment. The fuse holder is keyed to fit only in its proper orientation. Apply sufficient pressure evenly against the holder to engage the two locks. The holder is flush against the panel when both locks are engaged.
5. Reconnect the main power cord and turn on the power.

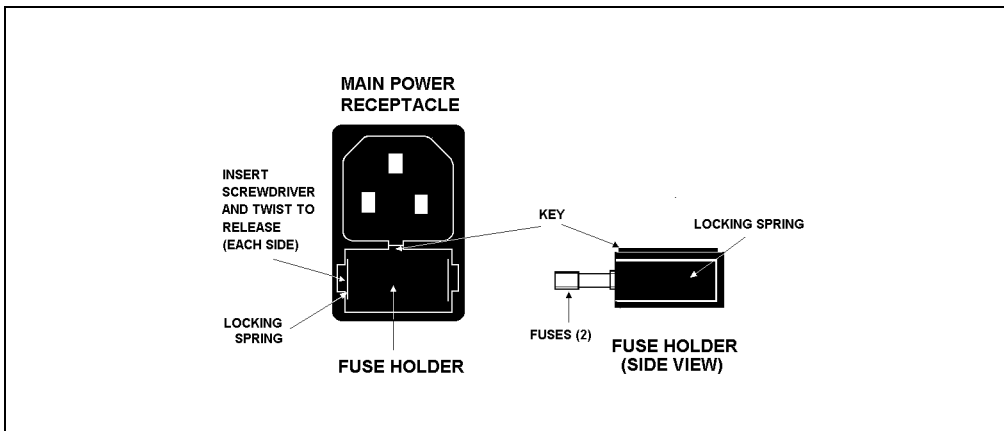

Figure 5-6. Main Power Fuse Holder

5.6 Eliminating Liquid Leaks

The IC20 is plumbed with 1.60-mm (1/16-in) OD PEEK tubing, ferrule fittings (P/N 043276), and 10-32 fitting bolts (P/N 043275). For tightening requirements, refer to *Installation of Dionex Ferrule Fittings*.

5.7 Removing Trapped Air from the Cell

Air bubbles in the cell can cause pulsations in the baseline, random noise, and low readings. Air may result from outgassing of the eluent. Connecting backpressure tubing to the cell (see below) applies enough backpressure to shrink bubbles and allow them to pass more easily through the cell.

1. Connect a piece of 0.25-mm (0.010-in) ID tubing (P/N 042690), with fittings on both ends, to the cell outlet. The tubing should be no longer than 1 m for 1.0 mL/min and 2 m for 0.5 mL/min.
2. If additional tubing is needed to reach the waste container, use a union (P/N 042627) to adapt to tubing with an ID of 0.5 mm (0.020 in) or larger.

IMPORTANT

The added backpressure must not exceed 0.20 MPa (30 psi). Avoid large increases in flow rate that would result in more than 1.4 MPa (200 psi) being applied to the cell.

5.8 Calibrating the Cell

Every conductivity cell is calibrated before shipment from the factory. The cell calibration constant is recorded on a tag attached to the cell cable. It is also stored in permanent IC20 memory for use when calculating the measured conductivity.

The calibration constant normally remains unchanged, unless the cell is damaged. To check the value entered in memory, select **CALIBRATION MENU** from the **DIAGNOSTIC MENU** to display the **CELL CALIBRATION** screen. If the cell calibration constant shown on the screen does not match the value recorded on the tag, calibrate the conductivity cell.

- Calibrate the cell to 147.00 μ S/cm, using 1 mM KCl. This automatically enters a new value for the cell calibration constant into memory.

To calibrate the cell, follow the procedure below.

1. Connect the pump output line directly to the cell inlet.
2. Pump 0.001 M KCl calibration solution through the cell. Conductivity is slightly flow-rate sensitive, so select the flow rate used for most applications.
3. Set **TEMP COMP** on the **METHOD** screen to 1.7%.
4. Wait until the conductivity reading stabilizes (within 0.1 μ S), and then select **CAL**.
5. After calibration, the conductivity reading should be exactly 147.00 μ S/cm. A new value for the cell constant will be shown on the **CELL CALIBRATION** screen and will be entered into memory.
6. Flush the KCl solution from the system by pumping deionized water through the cell lines. When the conductivity reading drops to near zero, stop the pump.
7. Disconnect the pump from the cell.
8. Reconnect the pump to the chromatography module.
9. Reconnect the liquid line from the SRS outlet to the cell inlet.
10. Reset **TEMP COMP** to the optimal value for the eluent.
11. Select a flow rate that is safe for the system in use.

A • Specifications

A.1 Electrical

Main Power 100 to 240 Vac, 50/60 Hz. The power supply is auto-sensing and requires no voltage adjustment.

Fuses Two 3.15 amp fast-blow IEC127 fuses (P/N 954745)

A.2 Environmental

Operating Temperature 10 °C to 60 °C (50 °F to 140 °F)

Operating Humidity 5 to 95% relative humidity (non-condensing)

A.3 Physical

Dimensions 32.8 cm high x 22 cm wide x 41 cm deep
(13.1 x 8.8 x 16.4 in)
6 cm (2.4 in) clearance behind the IC20 is required

Weight 20.3 kg (45 lbs)

Decibel Level No more than 60 db (at “A WEIGHING” setting)

A.4 Display and Keypad

Display Liquid crystal display with adjustable backlighting

Keypad 28 buttons for entering commands and numerical values

A.5 Hydraulics

| | |
|----------------------------|------------------------------------------------------------------------------------------------------------------------|
| Pump | Dual-piston, variable speed stroke of 100 μ L; user-selectable constant pressure or constant flow feedback control |
| Flow Rate | 0.04 to 10.0 mL/min, linearly variable in increments of 0.01 mL/min |
| Operating Pressure | 21 MPa (3000 psi) maximum |
| Pressure Resolution | 0.07 MPa (10 psi) |
| High Pressure Limit | 0 to 35 MPa (0 to 5000 psi) in increments of 0.05 MPa (7.25 psi); trips instantaneously |
| Low Pressure Limit | 0 to 35 MPa (0 to 5000 psi) in increments of 0.05 MPa (7.25 psi); trips after a timeout of 0.4 mL |
| Delay Volume | Approximately 700 μ L |

A.6 Conductivity Detector

| | |
|---------------------------------|-------------------------------------------------------------------|
| Range | 0.01 μ S to 3000 μ S, full-scale |
| Temperature Compensation | 0.0 to 3.0% per $^{\circ}$ C |
| Cell Drive | Variable 8 kHz square wave |
| Control Modes | Local or remote by relay contact-closures or the DX-LAN interface |

A.7 Conductivity Cell

| | |
|-------------------------|--------------------------------|
| Cell Body | PEEK |
| Active Volume | <1.0 μ L |
| Maximum Pressure | 2.0 MPa (300 psi) |
| Electrodes | Passivated 316 stainless steel |

A.8 SRS Power Supply

Supply Current 50, 100, 300, 500 mA @ 1.5 to 7.5 V

Over-Voltage Alarm 8.5 V

Over-Temperature Alarm 40 °C (104 °F)

A.9 Vacuum Degas Assembly (Optional)

Channels Single-channel or dual-channel membrane vacuum degas

Materials Wetted materials, PEEK, PTFE

A.10 Method Control

Methods Stores up to 100 separate methods (00 to 99). Each method may contain up to 50 separate steps; the actual number of stored methods depends on the available memory.

Control The keypad is used to select operating parameters and to program methods.

Storage Non-volatile memory protects against the loss of programs during power-down or in the event of a power failure.

Remote Limited remote operation via TTL-input logic level, and TTL-output and relay contact closures, or full remote programming and control through PeakNet software and the DX-LAN interface.

B.1 Facility Requirements

Appendix A contains the IC20 specifications for power, operating temperature, and humidity. In addition to meeting the specifications listed in Appendix A, the installation facility should meet the following requirements:

- Install the IC20 on a sturdy workbench with at least 6 cm (2.5 in) free space behind the module for connections and ventilation. Install the IC20 at a height that ensures convenient viewing of the front panel display, as well as access to the interior.



CAUTION

Lift the IC20 only from the bottom or side surfaces. Lifting with the front panel door will damage the door hinges. Use caution when lifting the IC20; it weighs 19 kg (42 lbs).

- Provide a source of helium to pressurize the eluent and regenerant reservoirs, if used. The IC20 is capable of operation without head pressure on the eluents. The eluents must be thoroughly degassed and housed at least 8 inches above the IC20, either in an EO1 Eluent Organizer (P/N 044125) or in built-in eluent containment (such as the LC25 Chromatography Oven provides).
- Always filter eluents to remove small particulates that may contaminate the pump. Install an end-line filter (P/N 045987) on the end of each eluent reservoir line. Filters are supplied in the pressurizable reservoir Ship Kits. Refer to the *Pressurizable Reservoir Installation Instructions* for details.

B.2 Rear Panel Connections

B.2.1 Power Connection

Connect a modular power cord (IEC 320 C13) from the main power receptacle on the IC20 rear panel (see Figure B-1) to a grounded, single-phase, power source.



SHOCK HAZARD—To avoid electrical shock, a grounded receptacle is required. Do not operate or connect to AC power mains without an earthed ground connection.



Operation at AC input levels outside the specified operating voltage range may damage the IC20.



The power supply cord is used as the main disconnect device. Make sure the socket-outlet is located near the IC20 and is easily accessible.

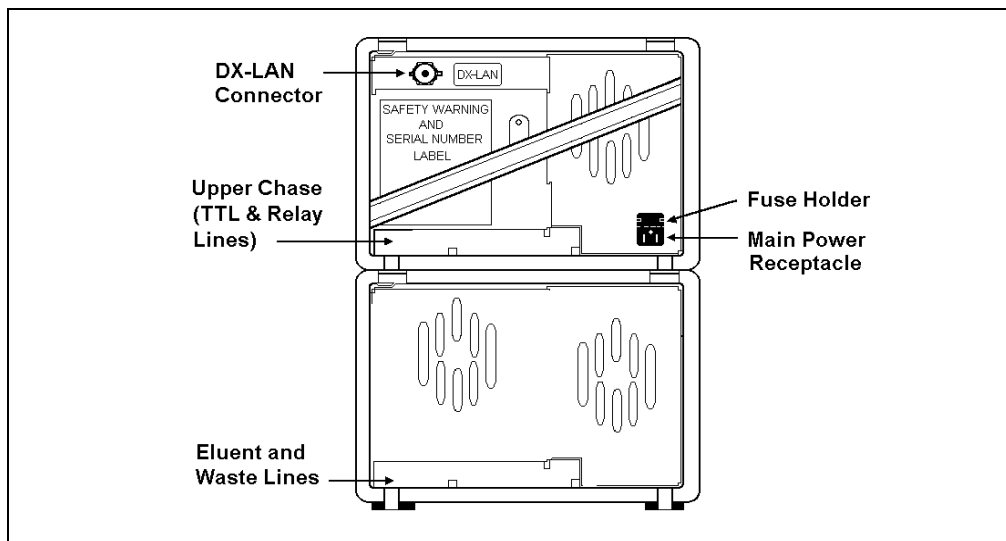

Figure B-1. IC20 Rear Panel

B.2.2 Waste Lines

There are two IC20 waste lines: one from the pressure transducer assembly and one from the leak drain. The waste lines are installed at the factory and then routed to the rear panel.

Place the free ends of the waste lines into a single waste container positioned below the level of the IC20. This will maintain a positive siphon (see Figure B-2).

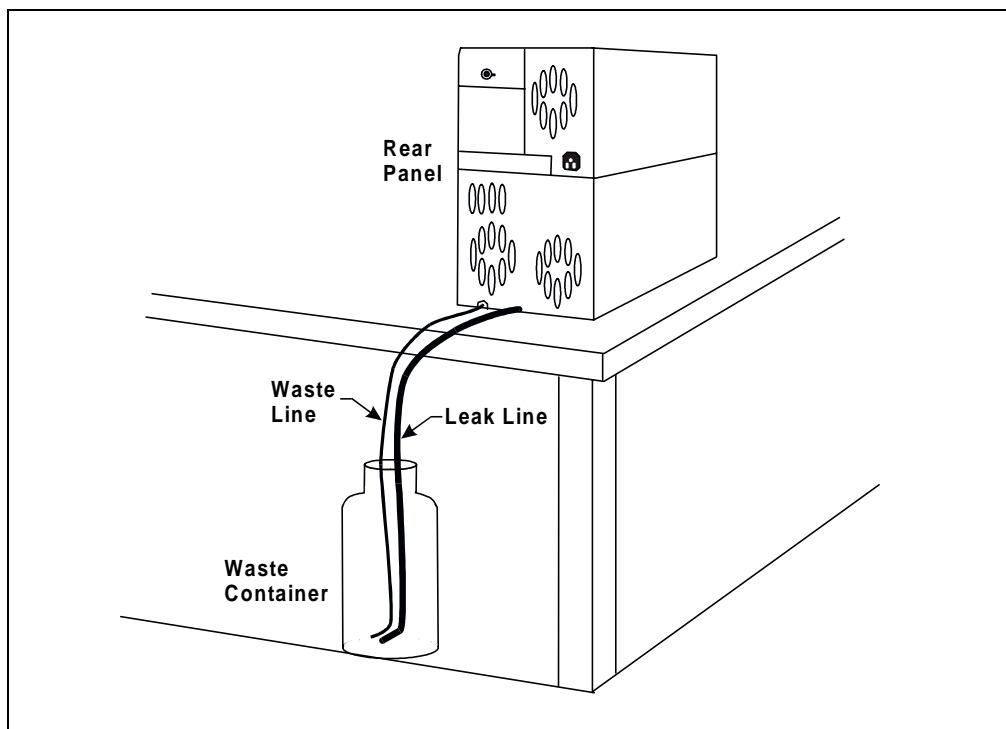

Figure B-2. Eluent Waste Lines

B.2.3 DX-LAN Network Connection (Optional)

For the IC20 to communicate with PeakNet software, a DX-LAN interface card (P/N 045587) must be installed in the IC20 and a DX-LAN cable (P/N 960405) must be connected to a DX-LAN BNC tee connector (P/N 921914) on the rear panel.

If you order a IC20 with the DX-LAN option, the card is installed at the factory. The tee connector and cable are shipped with the IC20.

Instructions for installing the tee connector and cable are in the next section.

If you order the DX-LAN later, the card, tee connector, and cable are included in a DX-LAN interface card kit (P/N 044196). Follow the steps below to install or replace a card.

Installing or Replacing a DX-LAN Interface Card

IMPORTANT

STATIC—The IC20 electronics are not user-serviceable and the DX-LAN interface card should be installed by qualified personnel only. Observe standard anti-static procedures when installing the interface card or handling the CPU card.



To prevent damage to the IC20, turn off the main power before installing the DX-LAN card. After confirming that the LED on the CPU card is off (not green or red), unplug the power. Do not rely on the front panel power switch.

1. If you are replacing a DX-LAN interface card, remove the hex nut securing the DX-LAN BNC connector to the IC20 rear panel (see Figure B-1).
2. Remove any TTL/Relay plugs from the connectors at slot 4 in the IC20 electronics chassis (see Figure B-3).
3. Disconnect the 60-pin ribbon cable from the inside of the front panel by first closing the tilt panel to expose the connector and its ejector latches. Remove the cable by opening the ejector latches.
4. Using a screwdriver as a lever, open the white ejector latch at the bottom of the CPU card. Remove the CPU card, cable, and Relay card as a single unit.

5. If you are replacing a card, remove the existing card from slot 4.
6. Insert the DX-LAN card (P/N 045587) into slot 4. Slide the card to the rear. Verify that the BNC connector on the card is aligned with the opening at the rear and that the card is aligned with the card connector. Press firmly on the card until it mates fully with the rear panel connector. Pull on the card to verify that it cannot move.
7. Reinstall the CPU/Relay card. Press firmly until the CPU card is inserted into the connector on the rear panel.
8. Reconnect the ribbon cable to the 60-pin connector on the inside of the front panel. The header and connector are key-polarized near the center. The ejector latches should be partially open to accept the cable connector.
9. Install the BNC tee connector and DX-LAN cable (see the next section).

Installing the BNC Tee Connector and DX-LAN Cable

1. Install the BNC tee connector (P/N 921914):
 - a. Note the two small locking pins on either side of the DX-LAN BNC connector on the rear panel (see Figure B-1).
 - b. Push the tee connector onto the BNC connector on the rear panel and twist until the locking pins are fully engaged in the slots on the tee connector.
 - c. Pull firmly on the tee connector to verify that it cannot move.
2. Install the DX-LAN cable (P/N 960405):
 - a. Push the metal sleeve on the end of the DX-LAN cable onto one port of the BNC tee connector.
 - b. Twist the metal sleeve until the locking pins on the tee are fully engaged in the slots on the cable's metal sleeve.
 - c. Pull the end of the cable to verify that it cannot move.

IMPORTANT

The DX-LAN cable is a 50 ohm coaxial impedance cable. (Fifty ohm cables are imprinted with “RG-58U” or “RG-58AU.”) Do not substitute an inferior cable, such as a 75 ohm television coaxial cable. Failure to install the correct cable or to lock it into place on the BNC tee connector will cause the module to lose communication with PeakNet.

3. If the IC20 is the last module in the network to be connected, install a terminator resistor plug (P/N 921034), shipped with PeakNet software, on the remaining port of the BNC tee connector. If this is not the last module, connect the cable from the next module to the BNC tee.

IMPORTANT

Terminator resistor plugs must be installed at each end of the DX-LAN network. Verify that both ends of the DX-LAN have terminator resistor plugs installed. The tee connector and cable are shipped with the IC20.

B.3 Electronics Chassis Connections

1. Route the cable from the injection valve through the IC20 upper chase and connect the cable to the **LC VALVE** connector in slot 1.
2. Route the cable from the SRS through the IC20 upper chase and connect the cable to the **SRS** connector in slot 2.

NOTE Refer to Appendix D for TTL and relay installation instructions.

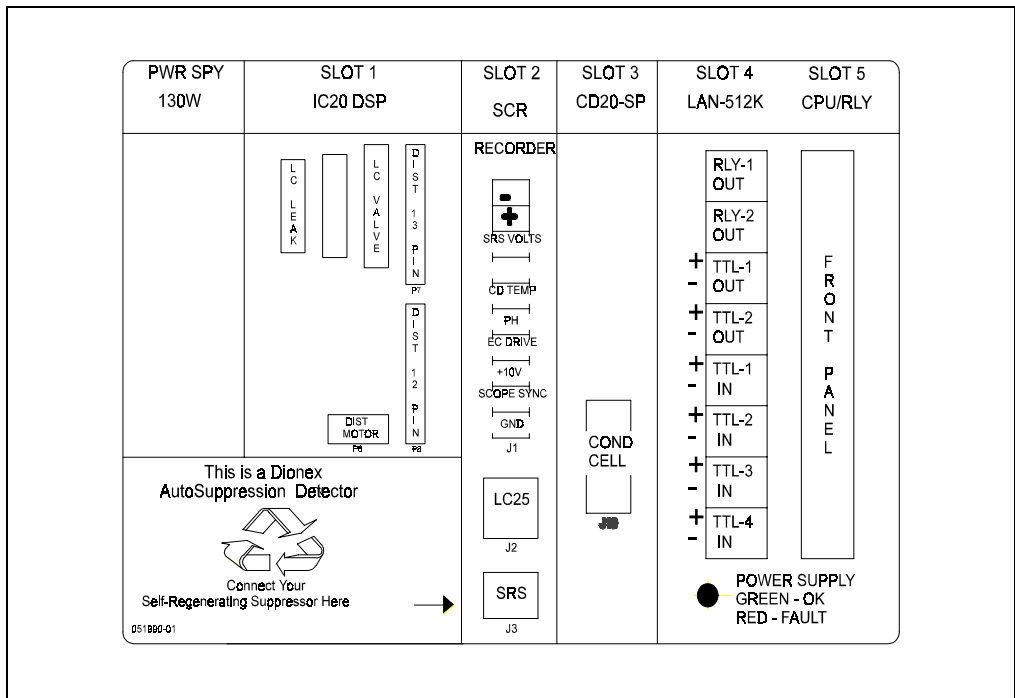

Figure B-3. IC20 Electronics Chassis
(Located behind upper door)

B.4 Eluent Reservoir Connections

B.4.1 Eluent Inlet Line Connection

Before shipment from the factory, the eluent inlet lines are connected to the eluent selection valve.

B.4.2 Eluent Outlet Line Connection

1. Route the eluent outlet line exiting the pump pressure transducer through the slot on the left side of the IC20 and connect it to the injection valve.

It is important to minimize the volume between the pump and the injection valve. If possible, after determining the relative positions of all system components, shorten the eluent line.

2. Untape the inlet lines from the rear panel and connect them to the eluent reservoirs. The standard IC20 includes one eluent inlet line; the IC20 with vacuum degas option has two lines, labeled “A” and “B.” If desired, label each eluent reservoir with the letter of the fitting it is connected to.

NOTE If an eluent channel will not be used, install a 1/4-28 plug (P/N 037628) in its fitting. This will improve the degas performance of the channel in use.

If spare parts are needed, order the following: eluent line “A” (P/N 047694) and/or eluent line “B” (P/N 047695).

3. If the eluent reservoirs are going to be pressurized, verify that a regulator (P/N 051997) is installed on the gas supply line to the reservoir. Turn on the gas supply and adjust the pressure to 55 KPa (8 psi).

If the eluent reservoirs are not pressurized, vent the bottles by loosening the reservoir cap or by removing the plug from the cap.



Never pressurize the reservoirs above 69 KPa (10 psi)

B.5 Priming the Pump

Two priming procedures are described below:

- Priming using the priming block
- Priming using the **PRIME** button on the IC20 front panel

B.5.1 Priming Using the Priming Block

1. Press **Menu** and **Enter** to go to the **MAIN** screen. If **REMOTE** mode is currently selected, move the cursor to that field and press a **Select** button to toggle to **LOCAL** mode. Press **Enter** or a cursor arrow button. If **METHOD** control is currently selected, move the cursor to that field, toggle to **DIRECT CNTRL**, and press **Enter** or an arrow.
2. Move the cursor to the desired eluent. Enter 100 to select 100% of that eluent and press **Enter** or a cursor arrow button. This automatically sets the other eluent to 0%.
3. Connect a 10 mL syringe (P/N 054578) to the luer port in the priming block. Turn the priming block valve counterclockwise one turn (see Figure B-4).

NOTE If the eluent is pressurized, liquid will flow into the syringe as soon as you open the valve.

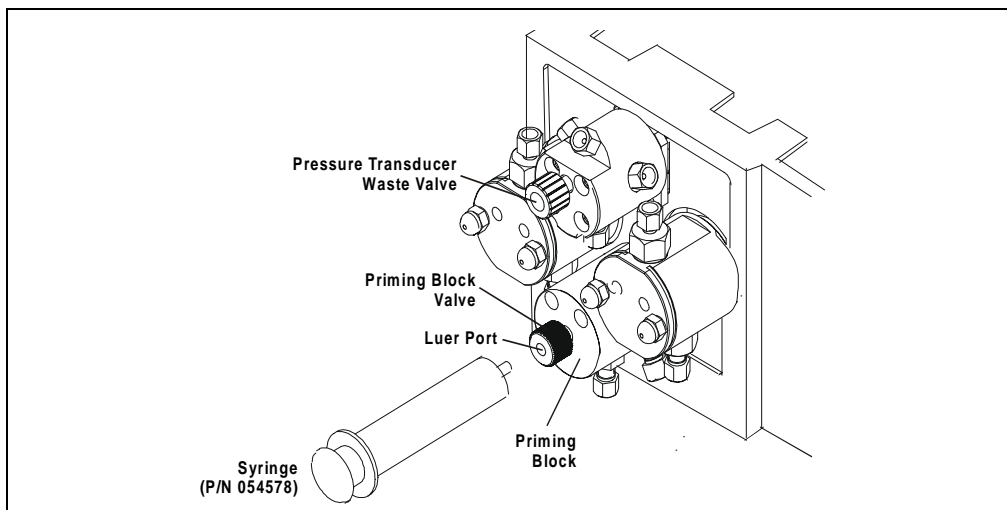

Figure B-4. Priming the Pump

4. Turn on the pump.
5. If the eluent is not pressurized, be sure that there is a vent from the eluent bottle or loosen the bottle caps. Draw the syringe back to pull eluent through the flow path. It may take several syringe draws to remove all air or previous eluents from the tubing. If the IC20 includes a vacuum degas pump, draw an additional 17 mL of eluent through the priming block.
6. Return to Step 2. Select the other eluent and repeat the priming procedure. Press **Prime** again to return the flow to the set flow rate.
7. When the pump has been primed thoroughly, turn the priming block valve counterclockwise until closed (see Figure B-4). Do not overtighten.

B.5.2 Priming Using the Prime Button

1. Open the **MAIN** screen and select **DIRECT CNTRL** and **LOCAL**.
2. Set the eluent to 100% of the line to be primed. Press **Enter** or a cursor arrow button.
3. Open the pressure transducer waste valve one to two turns counterclockwise. This will direct the eluent flow path to waste and eliminate backpressure.
4. Press **Prime** on the IC20 front panel. The pump will pump at 9.9 mL/min for a standard bore pump and 2.5 mL/min for a microbore pump.

NOTE A vacuum degas module contains 17 mL of eluent. If this option is installed in the IC20, several extra minutes of prime time must be added to sufficiently purge air and previous eluent from the degas unit.

5. Allow the pump to prime until all air and previous eluents are purged and no air bubbles can be seen exiting the waste line. If the eluent manifold has not been primed, allow several extra minutes for the eluent to pass through the pump.
6. Press **Prime** again to return the flow to the set flow rate.
7. Close the pressure transducer waste valve. The pump is now ready for operation.

B.5.3 Priming the Pump Heads with Isopropyl Alcohol

NOTE Prime the pump heads with alcohol only if the regular procedure, described before, is ineffective.

1. Connect a 10 mL syringe (P/N 054578) to the luer port on the priming block (see Figure B-4).
2. Open the pressure transducer waste valve (see Figure B-4) by turning the knob counterclockwise about two turns.
3. Turn the priming block valve counterclockwise about two turns.
4. Turn on the pump.
5. Use the syringe to slowly push alcohol through the pump. Avoid pushing any air trapped in the syringe through the pump, as this will result in loss of prime. Verify that alcohol with no trapped bubbles is traveling down the waste line from the transducer.
6. Continue pushing on the syringe until you have closed the priming block valve. Do not overtighten. Disconnect the syringe from the priming block. The pressure transducer waste valve should remain open.
7. Press **Prime** to purge the alcohol from the pump heads and flush the heads with the desired eluent.



Alcohol may damage some columns. Be sure to rinse the alcohol from the pump, using the process described above.

8. Close the pressure transducer waste valve. The pump is now ready for operation.

B.6 Automatic SRS Power Control (Optional)

TTL connections can be used to automatically switch off the power to the Self-Regenerating Suppressor (SRS). When the IC20 is set up for this option, a TTL signal is sent to the IC20 when the pump flow stops and then, 5 minutes later, the IC20 will turn off the SRS power. The 5-minute delay allows momentary flow interruptions without disturbing the SRS.

1. Open the **PUMP OPTIONS** screen and set **TTL2 OUTPUT USAGE** to **0 FLOW**.
2. Open the **TIME FUNCTION IN** screen and assign TTL3 to **PUMP/SRS ON/OFF**. Select the **NORMAL EDGE** mode.
3. Locate a pair of twisted black and red wires (P/N 043598) and two green TTL connector plugs (P/N 921019) in the IC20 Ship Kit.
4. Insert the wires into the plugs, with the signal wire (red) on top and the ground wire (black) on the bottom.
5. Plug one end of the cable into **TTL2 OUT** on the IC20 (see Figure B-5). Plug the other end of the cable into **TTL3 IN**.

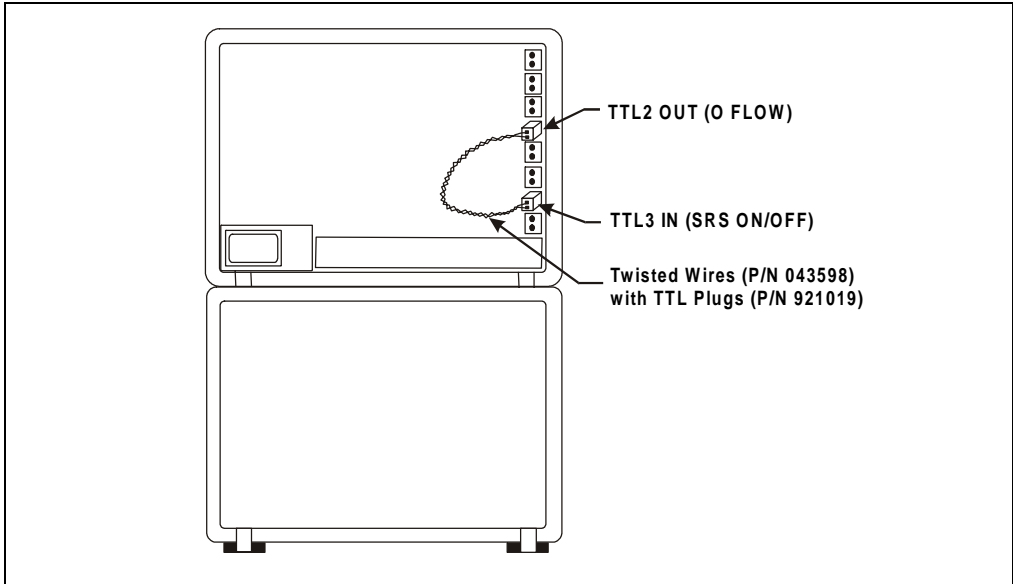

Figure B-5. TTL Connections for SRS Power Control
(IC20 Front View without Upper Door)

C • User Interface

This appendix illustrates and describes all of the screens that can be displayed from the front panel of the IC20 Ion Chromatograph. There are four types of screens (see Figure C-1):

- **Operational** screens are used to create, edit, and run the methods that control IC20 operation.
- **Setup** screens are used to select default system parameters.
- **Diagnostic** screens provide access to IC20 diagnostic information and tests.
- **Calibration** screens provide a way to calibrate various IC20 functions; for example, the flow rate and pressure offset.

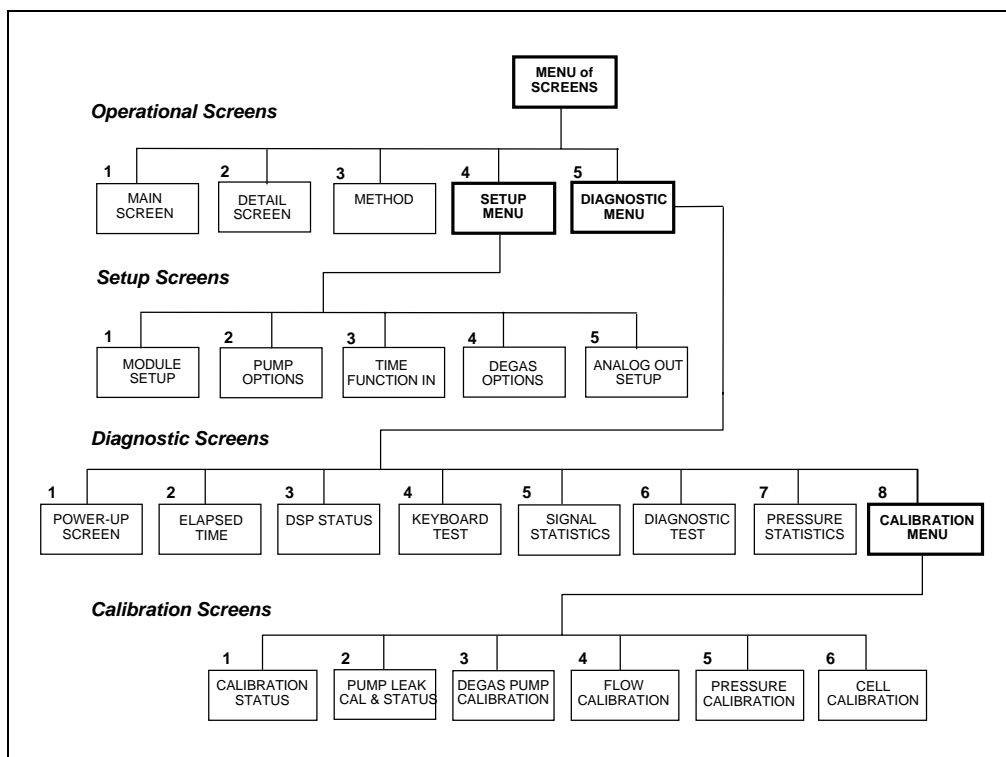

Figure C-1. IC20 Menu Structure

Menu of Screens

This screen provides top-level access to the IC20 operational screens and the **DIAGNOSTIC MENU**. It is displayed when **MAIN** is pressed.

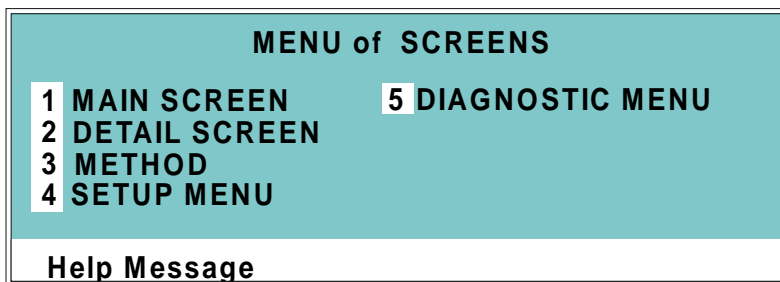

Figure C-2. Menu of Screens

There are two ways to select a screen from a menu:

- Press the number button on the keypad that corresponds to the menu option. For example, on the **MENU of SCREENS**, press **4** from anywhere on the screen to display the **SETUP MENU**.
- Move the cursor to the field containing the screen number and press **Enter**.

To display a brief description of each screen, press **Help**.

C.1 Operational Screens

C.1.1 Main Screen

The mode of operation, the method number to run (when using Method control), and basic operating parameters (when using Direct control) are selected from the **MAIN** screen.

Active data is displayed on the screen in large characters.

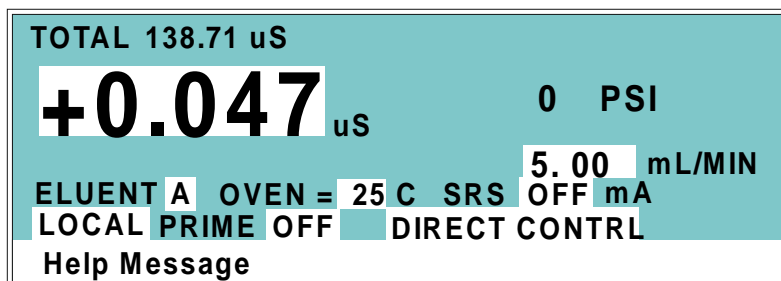

Figure C-3. Main Screen

| Field | Description |
|-----------------------|---------------------------------------------------------------------------------------------------------------------------------------------------------------------------------------------------------|
| TOTAL | Displays total conductivity (without an offset). |
| PSI (MPa, BAR) | Displays the system backpressure in psi, MPa, or bar. Set the unit of measure from the PUMP OPTIONS screen. |
| mL/MIN | Displays the eluent flow rate in milliliters per minute. In Direct control, set the flow rate in this field, also. The flow rate is programmed in the Method when using Method control. |
| ELUENT | Selects eluent A or B. |
| OVEN | Sets the temperature of the LC25 Chromatography Oven. |
| SRS | Selects the amount of current sent to the Self-Regenerating Suppressor. The discrete settings are Off, 50, 100, 300, and 500 mA. Current selection depends on the eluent concentration, flow rate, etc. |

| Field | Description |
|---------------------------------------|----------------------------------------------------------------------------------------------------------------------------------------------------------------------------------------------------------------------------------------------------------------------------------------------------------------------------------------------------------------------------------------------------------------------------------------------------------------------------------------------------------------------|
| LOCAL/ REMOTE | Press either Select button to toggle between the Local and Remote modes. Local mode is used for full front panel control when a PeakNet workstation is not configured. The IC20 will automatically switch to remote mode when a command is given from PeakNet. A command from PeakNet can set the IC20 to the Locked Remote mode, which prevents operation from the keypad. The Locked Remote mode can be canceled only by a new command from PeakNet or by turning off the IC20 and then turning it back on. |
| PRIME | Turns the pump priming ON or OFF . |
| DIRECT CONTROL/ METHOD | Press either Select button to toggle between the Direct Control and Method operating modes. |

C.1.2 Detail Screen

The **DETAIL** screen indicates the current settings for various IC20 operating parameters. Refer to the **MAIN** screen for a description of fields that are common to both screens.

| | | | | |
|--------------------|---------------|-----------|-------|---|
| 0 PSI | OUTPUT | 0.05 uS | TTL1 | 0 |
| 5.00 mL/MIN | OFFSET | 189.13 uS | TTL2 | 0 |
| LOAD | TOTAL | 189.18 uS | RLY1 | 0 |
| SRS OFF mA | RANGE | 100 uS | RLY2 | 0 |
| TEMP COMP 1.7 | OVEN TEMP | 25 C | READY | |
| LIMIT 0 - 5000 PSI | P-POINT | L= 0 R= 0 | | |
| LOCAL | DIRECT CONTRL | | | |
| Help Message | | | | |

Figure C-4. Detail Screen

| Field | Description |
|----------------------------|---------------------------------------------------------------------------------------------------------------------------------------------------------------------|
| Valve position | Sets the position of the injection valve to INJECT or LOAD . |
| TEMP COMP | Sets the temperature compensation factor. The range is 0 to 3%. 1.7% is appropriate for most eluents. |
| LIMIT | The pressure limit range value in psi, MPa, or bar. |
| P-POINT | Reports the current pressurization point for the left and right pump pistons. |
| TTL1 TTL2 | Provides TTL control of accessories. In a method, these values occur according to the method timing. In Direct control, select off (0) or on (1). |
| RLY1 RLY2 | Provides relay contact closure control of accessories. In a method, these values occur according to the method timing. In Direct control, select off (0) or on (1). |

C.1.3 Method Screen

Select, edit, and save methods from the **METHOD** screen.

NOTE The **TEMP COMP**, **OVEN TEMP**, and **SRS** fields are not time-programmable.

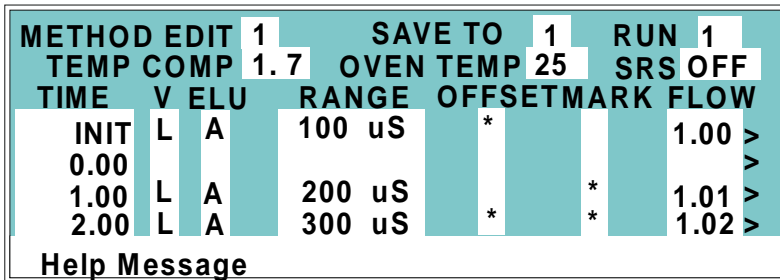

Figure C-5. Method Screen

| Field | Description |
|--------------------|---------------------------------------------------------------------------------------------------------------------------------------------------------------------------------------------------------|
| METHOD EDIT | The method number (0 through 99) to edit. |
| SAVE TO | The method number (0 through 99) the current method will be saved to. This may be either the edit number or a different number. |
| RUN | The method number (0 through 99) to run. Entering a method number here does not affect the status of the method clock. The Run Method button on the front panel keypad controls the clock. |
| TEMP COMP | Sets the temperature compensation factor. The range is 0 to 3%; 1.7 is appropriate for most eluents. |
| OVEN TEMP | Selects the temperature of the LC25 Chromatography Oven. |
| SRS | Selects the amount of current sent to the Self-Regenerating Suppressor. The discrete settings are Off, 50, 100, 300, and 500 mA. Current selection depends on the eluent concentration, flow rate, etc. |

| Field | Description |
|---------------|-----------------------------------------------------------------------------------------------------------------------------------------------------------------------------------------------------------------------------------------------------------------------------------------|
| TIME | The elapsed time for each method step. Every method must begin with the INIT (initial) step, followed by the TIME0.00 step. Each additional entry under TIME indicates the elapsed time at which the specified conditions (valve position, flow rate, etc.) occur. |
| V | Sets the position of the injection valve to INJECT or LOAD . |
| ELU | Selects the eluent (A or B). |
| RANGE | Sets the analog output range. Select a range between 0.01 and 3000 μ S. |
| OFFSET | Stores the offset value. The baseline is set by subtracting the offset measured when this step is executed from all subsequent measurements. An asterisk (*) indicates that offset will occur at this time. |
| FLOW | The flow rate through the pump, in milliliters per minute. |
| MARK | Sends a positive pulse to the analog output (recorder) as an event marker. An asterisk (*) indicates that a mark will occur at this time. |
| v | A small “v” adjacent to the bottommost time entry indicates there are additional lines below the last line in the screen. Use the arrow buttons to scroll down to the additional lines. |
| ^ | A caret (^) adjacent to the topmost time entry indicates there are additional lines above the top line. The caret displays only when the screen is scrolled down additional lines. Use the arrow buttons to scroll up to the additional lines. |

C.1.4 Module Setup

Select miscellaneous settings from this screen. These remain the default settings for the IC20 until new selections are made.

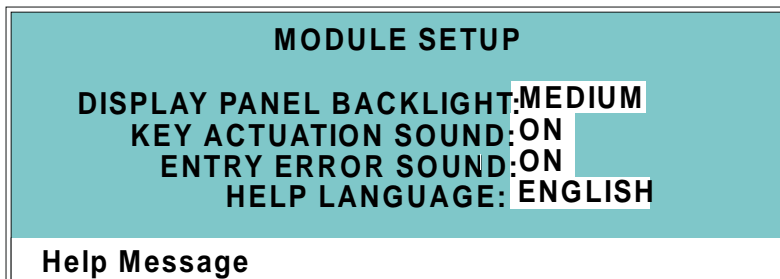

Figure C-6. Module Setup Screen

| Field | Description |
|-------------------------|------------------------------------------------------------------|
| DISPLAY PANEL BACKLIGHT | Sets the backlight to LOW, MEDIUM, HIGH , or OFF . |
| KEY ACTUATION SOUND | Toggles the key actuation sound ON or OFF . |
| ENTRY ERROR SOUND | Toggles the error entry sound ON or OFF . |
| HELP LANGUAGE | Selects the language for on-screen help messages. |

NOTE If no keypad buttons are pressed within a two-hour period, the backlight automatically turns off. To turn the backlight on again, press any keypad button. Press the button a second time to activate its function.

C.1.5 Pump Options

| PUMP OPTIONS | |
|---------------------|-------------|
| PUMP HEAD MATERIAL: | INERT |
| PUMP HEAD VOLUME: | 100 μ L |
| CONTROL MODE: | PRESSURE |
| TTL2 OUTPUT USAGE: | 0 FLOW |
| PRESSURE UNITS: | PSI |
| Help Message | |

Figure C-7. Pump Options Screen

| Field | Description |
|---------------------------|------------------------------------------------------------------------------------------------------------------------------------------------------------------------------------------------------------------------------------------------------------------------------------------------------------------------------------------------------------------------------------------------------------|
| PUMP HEAD MATERIAL | Reports the head material, INERT (for PEEK heads). This parameter cannot be changed. |
| PUMP HEAD VOLUME | Reports the head volume, 100 μL. This parameter cannot be changed. |
| CONTROL MODE | Sets the pump flow control mode to PRESSURE or FLOW . Pressure mode uses pressure as the primary source of feedback to maintain flow rate stability. Flow mode uses motor speed as the primary source of feedback to maintain stability. |
| TTL2 OUTPUT USAGE | Selects the active state of the TTL2 output signal. Select 0 FLOW or NORMAL . To automatically switch off the power to a Self-Regenerating Suppressor when the pump flow stops, select the 0 FLOW option and connect TTL2 out on the pump to TTL3 in on the detector (see Section B.6 for detailed connection instructions). Select NORMAL to activate TTL2 as a standard TTL. |
| PRESSURE UNITS | Selects the unit of measure for pressure (PSI , MPa , or BAR). |

C.1.6 Time Function In

This screen displays functions that can be controlled by a TTL input from another device. Four input TTL controls may be assigned to the time input functions. Control is enabled when Local mode is selected.

Use the **Select** buttons to assign TTL1 through TTL4 to any four of seven IC20 functions. The default assignments are shown in Figure C-8.

| | | | |
|----------------------------|--------------|-------------------|--------------------|
| TIME FUNCTION IN | MODE: | NORMAL | EDGE |
| PUMP/SRS ON/OFF: | | TTL1 | |
| RUN METHOD: | | TTL2 | |
| OFFSET: | | TTL3 | |
| METHOD NUMBER INCR: | | TTL4 | DECR: TTL _ |
| MARK: | | TTL_ (OUT) | |
| RANGE X10: | | TTL _ | |
| Help Message | | | |

Figure C-8. Time Function In Screen

| Field | Description |
|-------------|---------------------------------------------------------------------------------------------------------------------------------------------------------------------------------------------------------------------------------------------------------------------------------------------------------------------------------------------------------------------------------------------------------|
| MODE | <p>The MODE field determines the type of input signal the IC20 responds to. Select NORMAL EDGE, INVERTED EDGE, NORMAL PULSE, or INVERTED PULSE. Normal edge, the default, is compatible with the TTL output signals provided by Dionex modules.</p> <p>The signal type can be changed to match the signal of the controlling device; see Appendix D for details.</p> |

C.1.7 Degas Options

Set the cycle duration and frequency for the optional degas pump from the **DEGAS OPTIONS** screen.

| DEGAS OPTIONS | | DEFAULT |
|----------------------|------------|---------|
| DEGAS PUMP: | BY SETTING | |
| START-UP DURATION: | 2 MIN | 2 MIN |
| CYCLE DURATION: | 30 SEC | 30 SEC |
| TIME BETWEEN CYCLES: | 10 MIN | 10 MIN |
| Help Message | | |

Figure C-9. Degas Options Screen

| Field | Description |
|----------------------------|-------------------------------------------------------------------------------------------------------------------------------------------------------------------------------------------------------------------------------------------------------------------------------------------------------------------------------------------------------------------------------------------------------------------------------------------------------------------------------------------------------------------------------------------------------------------------------------------------------------------------------------------------|
| DEGAS PUMP | <p>Selects one of the following operating options.</p> <ul style="list-style-type: none"> • BY SETTING: The degas pump runs according to the selected degas options. • MONITOR: The IC20 checks the degas vacuum reading once a minute. If the reading falls 500 counts below the calibration threshold value (shown on the DEGAS PUMP CALIBRATION screen), the degas pump turns on for the cycle duration time. • ALWAYS OFF: The degas pump is always off. • ALWAYS ON: The degas pump is always on. This setting is used for testing the pump during servicing. |
| START-UP DURATION | For how long the degas pump runs at power-up (2-5min). |
| CYCLE DURATION | For how long the degas pump runs during each cycle (0-120 sec). |
| TIME BETWEEN CYCLES | The elapsed time between cycles (1-99 min). |

The IC20 monitors the degas vacuum reading once a minute. If the degas vacuum reading is 2000 or more lower than the degas calibration value, the following error message displays:

```
LOW VACUUM ALARM!!  
Check DEGAS OPTIONS settings or refer to  
service manual
```

If this occurs, try increasing the **CYCLE DURATION** time and/or decreasing the **TIME BETWEEN CYCLES**. If adjusting these settings does not solve the problem, contact Dionex.

C.1.8 Analog Out Setup

Use the **ANALOG OUT SETUP** screen to set parameters for the analog output, such as for a recorder or oscilloscope.

| ANALOG OUT SETUP | |
|-------------------|-----------------|
| OUTPUT: | OFFSET |
| ZERO POSITION: | 10 % FULL SCALE |
| VOLTS FULL SCALE: | 1.0 V |
| RISE TIME: | 1.00 sec |
| POLARITY: | + |
| Help Message | |

Figure C-10. Analog Out Setup Screen

| Field | Description |
|-------------------------|-------------------------------------------------------------------------------------------------------------------------------------------------------------------------------------------------------------------------------------------------------------------------------------------------------------------------------------------------------------------------------------------|
| OUTPUT | Sets the analog output to one of the following: <ul style="list-style-type: none"> • OFFSET uses the offset level value. • TOTAL uses the total cell conductivity, charge, or current, disabling the offset function. • ZERO sets the output to zero volts. • FULL SCALE sets the output to the full-scale setting. |
| ZERO POSITION | Sets the analog (recorder) offset level (0-100%). |
| VOLTS FULL SCALE | Sets the full-scale voltage for a signal equal to the range setting. The discrete settings are 1.0, 0.1, and 0.01 volt. |
| RISE TIME | Sets the output filter rise time to 0.05, 0.1, 0.2, 0.5, 1.0, 2.0, 5.0, or 10.0 seconds. Rise time is a measure of how quickly the detector goes from 10% to 90% of step input changes. A digital filter is used with zero undershoot or overshoot for minimal peak distortion. |
| POLARITY | Determines the output voltage polarity. The output is usually set to positive polarity. Select negative polarity to reverse peaks from indirect detection. |

C.2 Diagnostic Screens

To access the IC20 diagnostics, select the **DIAGNOSTIC MENU** from the **MENU of SCREENS**.

When a diagnostic screen is displayed, pressing **Menu** opens the **DIAGNOSTIC MENU**. When the **DIAGNOSTIC MENU** is displayed, pressing **Menu** opens the **MENU of SCREENS**.

C.2.1 Diagnostic Menu

The **DIAGNOSTIC MENU** lists the available diagnostic screens. To display the menu, press **Menu, 5**.

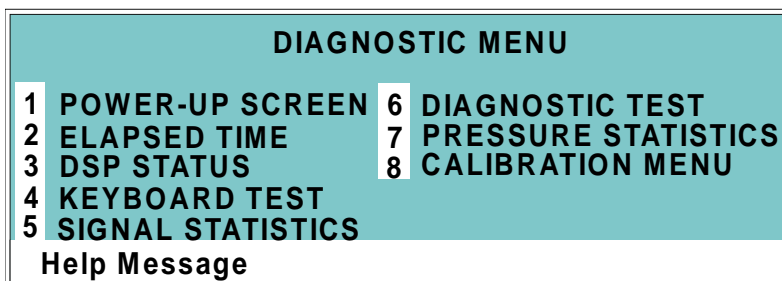

Figure C-11. Diagnostic Menu

C.2.2 Power-Up Screen

This screen is also displayed when the IC20 is powered up. When the IC20 is connected to the DX-LAN interface, the DX-LAN ID number will be displayed here.

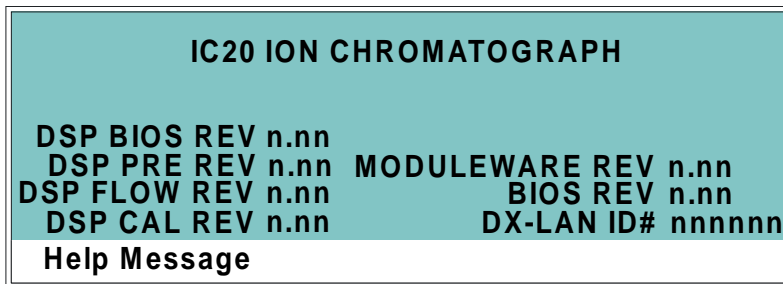

Figure C-12. Power-Up Screen

C.2.3 Elapsed Time

This screen reports for how long various components have been in use. The status is updated in real time.

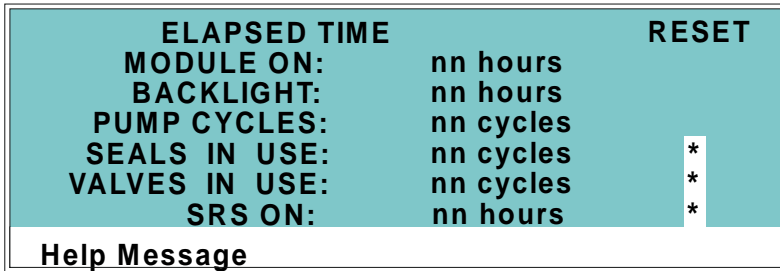

Figure C-13. Elapsed Time Screen

| Field | Description |
|----------------------|---------------------------------------------------------------------------------------------------------------------------------------------------------|
| MODULE ON | Reports the total time the IC20 has been powered up in its lifetime. |
| BACKLIGHT | Reports the total time the display backlight has been on in its lifetime. |
| PUMP CYCLES | Reports the total cumulative number of pump cycles during the life of the motor. This field automatically resets to 0 after the pump motor is replaced. |
| SEALS IN USE | Reports the total number of pump cycles since the last time the seals were replaced. Reset this field to 0 when the seals are replaced. |
| VALVES IN USE | Reports the total number of pump cycles since the last time the check valves were serviced. Reset this field to 0 when the valves are serviced. |
| SRS ON | Reports the total time the Self-Regenerating Suppressor has run. Reset this field to zero after replacing the SRS. |

C.2.4 DSP Status

This screen reports the status of the DSP (Digital Signal Processor) dynamic parameters. The status is updated in real time.

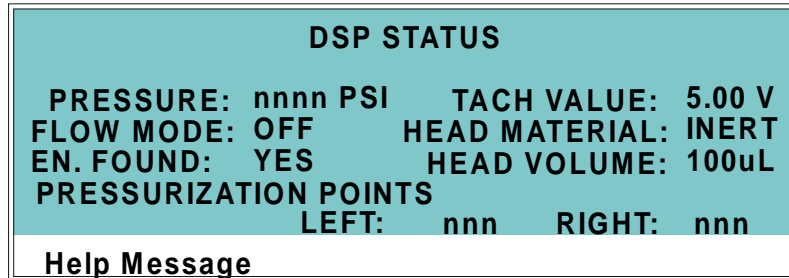

Figure C-14. DSP Status Screen

| Field | Description |
|------------------------------|----------------------------------------------------------------------------------------------------------------------------------------------------------------------------------------------------------------------------------------------------------------------------------------------------|
| PRESSURE | Reports the current head pressure in psi, MPa, or bar. |
| TACH VALUE | Reports the current motor tachometer reading in volts. |
| FLOW MODE | Reports the flow mode as ON (when the pump is in constant flow mode) or OFF (when the pump is in pressure feedback mode). |
| HEAD MATERIAL | Reports the head material, INERT (for PEEK heads). This parameter cannot be changed. |
| EN. FOUND | Reports whether the encoder is found. |
| HEAD VOLUME | Reports the head volume, 100 μ L. This parameter cannot be changed. |
| PRESSURIZATION POINTS | Reports the current pressurization point for the left and right pistons. The pressurization points are the points at which the pump speed is adjusted at each stroke to maintain a constant flow rate. When the pump has stabilized, the left and right values are approximately equal (within 5). |

C.2.5 Keyboard Test

Use this screen to conduct an interactive test of the front panel keypad buttons.

| | | | | | | |
|---------------------|--------|----------|--------|---|---|---|
| INJECT | OFFSET | UP | 7 | 8 | 9 | |
| RUN/HOLD | RESET | LEFT | RIGHT | 4 | 5 | 6 |
| REMOTE | INSERT | SEL DOWN | SEL UP | 1 | 2 | 3 |
| OFF/ON | DELETE | HELP | MENU | 0 | . | E |
| Help Message | | | | | | |

Figure C-15. Keyboard Test Screen

To test the buttons:

1. Press a button on the IC20 keypad. Its display changes to reverse video, confirming proper operation of the button.
2. Continue pressing each button in turn. Only the most recently pressed button shows in reverse video.
3. To end the test and return to the **DIAGNOSTIC MENU**, press **Menu** twice.

C.2.6 Signal Statistics

This screen lets you monitor the selected input to the A/D circuitry. When the screen is initially displayed, the **MAX** and **MIN** status values are equal to the **INPUT** value and **DURATION** reads 0. Status values are reported in A/D volts and are updated dynamically.

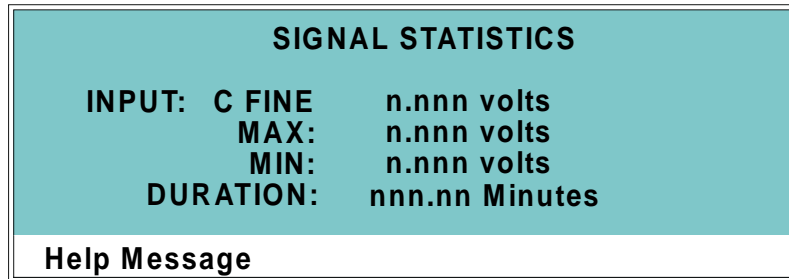

Figure C-16. Signal Statistics Screen

| Field | Description |
|-----------------|--------------------------------------------------------------------------------------------------------------------------------------------------------------------------------------------------------------------------------------|
| INPUT | The measured data from the A/D circuit: C FINE—Conductivity cell fine input C COARSE—Conductivity cell coarse input C THER—Conductivity cell thermistor input LEAK—Leak detector input DRIVE—Cell drive circuit input |
| MAX | The maximum input data value during the duration of the test. |
| MIN | The minimum input data value during the duration of the test. |
| DURATION | The test duration (in minutes). The test starts when this screen is opened and terminates when the screen is closed. |

C.2.7 Diagnostic Test

Use this screen to test the IC20 electronics components. Some of these tests run automatically at power-up; if one of the tests fails, this screen appears, displaying the status of each test.

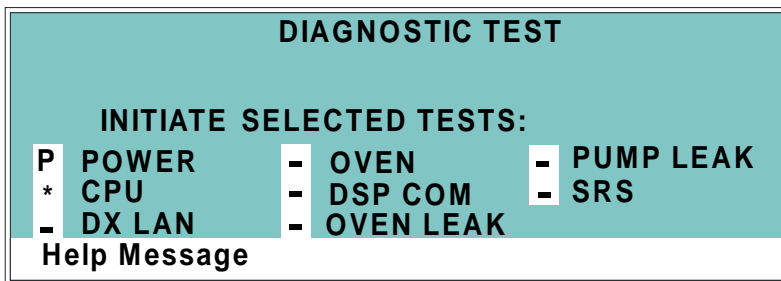

Figure C-17. Diagnostic Test Screen

To run a test, position the cursor in the edit field beside the test name, press a **Select** button to display an asterisk (*), and press **Enter**. When the test is complete, the edit field displays either pass (**P**) or fail (**F**).

| Field | Description |
|-----------|-----------------------------------------------------------------------------------------------------------------------------------------------------|
| POWER | Checks the +5, ±15, and +24 volt monitor on the Relay card. |
| CPU | Checks the CPU internal configuration and the Moduleware checksum. |
| DX-LAN | Checks the DX-LAN hardware configuration and loop back. |
| OVEN | Varies the temperature set point of the LC25 Chromatography Oven and checks the flags. |
| DSP COM | Checks communication between the CPU and the DSP (Digital Signal Processor) hardware by sending a command and waiting for the appropriate response. |
| OVEN LEAK | Checks the leak sensor in the LC25 Chromatography Oven for a correct, open circuit, or short circuit condition. |
| PUMP LEAK | Checks the pump's leak sensor for a correct, open circuit, or short circuit condition. |
| SRS | Varies the SRS power supply and checks the flags. |

NOTE Exiting the **DIAGNOSTIC TEST** screen clears the pass/fail indicators from the edit fields.

C.2.8 Pressure Statistics

This screen monitors the pressure transducer and reports pressure status values. Status values are updated while the screen is displayed.

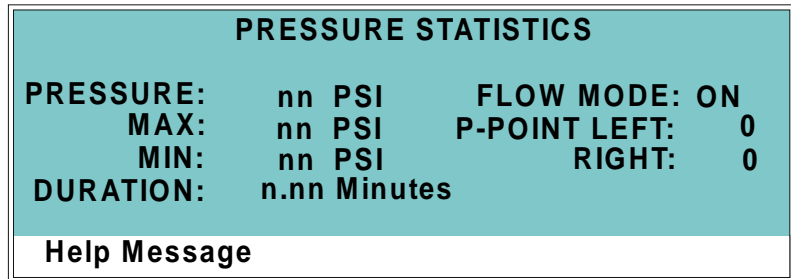

Figure C-18. Pressure Statistics Screen

If a method is running when the **PRESSURE STATISTICS** screen is opened, the following message displays:

```
Active Method Lowers MIN/MAX Resolution
```

For more accurate readings, abort the method, change to Direct control mode, and then reopen the screen.

| Field | Description |
|-------------------------------|---------------------------------------------------------------------------------------------------------------------------------------------------------------------------------------------------------------------------------------------------------------|
| PRESSURE | The measured pressure from the pressure transducer. |
| MAX | The maximum pressure value during the duration of the test. |
| MIN | The minimum pressure value during the duration of the test. |
| DURATION | The duration of the test. The test starts upon entering this screen and terminates upon exiting by pressing the Menu button. To restart the test, press Reset ; the duration is set to 0 and all status values are set to the current pressure. |
| FLOW MODE | Reports the flow mode as ON or OFF . ON = System is in constant flow mode. OFF = System is in pressure feedback mode. |
| P-POINT LEFT RIGHT | Reports the current pressurization point for the left and right pistons. The readout is updated once per piston stroke. |

C.3 Calibration Screens

To go to the **CALIBRATION MENU**, press **Menu, 5, 8**.

C.3.1 Calibration Menu

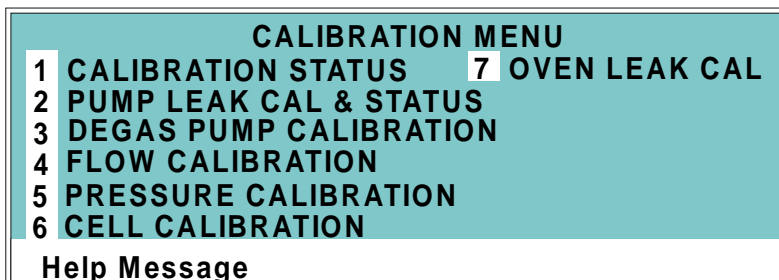

Figure C-19. Calibration Menu Screen

C.3.2 Calibration Status

This screen reports the status of calibration parameters in real time.

| CALIBRATION STATUS | |
|-----------------------------------|-----------------|
| FLOW RATE CAL: | n.nn g |
| PRESSURE OFFSET: | nnnn PSI |
| CAM ENCODER CAL VALUE: | nnn |
| CELL CALIBRATION CONSTANT: | nnn |
| Help Message | |

Figure C-20. Calibration Status Screen

| Field | Description |
|----------------------------------|-------------------------------------------------------------------------------------------------------------------------------------------------------------------------------------------------------------------------------------------|
| FLOW RATE CAL | The current flow rate calibration value. |
| PRESSURE OFFSET | The pressure offset calibration value reported by the DSP. |
| CAM ENCODER CAL VALUE | The current binary value for cam-encoder calibration reported by the DSP. |
| CELL CALIBRATION CONSTANT | The calibration constant of the conductivity cell. This is usually the value determined when the cell is calibrated before shipment to the user. Unless the cell is damaged, the calibration constant should not need to be recalibrated. |

C.3.3 Leak Sensor Calibration and Status

This screen reports the status of leak sensor parameters. The **PUMP** column displays the status of the pump's internal leak sensor. The **EXTERNAL** column displays the status of the leak sensor in the LC25 Chromatography Oven. If no LC25 is connected to the IC20, the **EXTERNAL** fields display **NONE**.

| PUMP LEAK SENSOR CALIBRATION AND STATUS | | |
|-----------------------------------------|------|----------|
| | PUMP | EXTERNAL |
| MEASURED VALUE: | 0.00 | 2.75 |
| CURRENT CONDITION: | DRY | WET |
| CALIBRATION VALUE: | 2.50 | 2.60 |
| LOW LEAK THRESHOLD: | 2.70 | 2.50 |
| Help Message | | |

Figure C-21. Leak Sensor Calibration and Status

| Field | Description |
|---------------------------|-----------------------------------------------------------------------------------------------------------------------------------------------------------------------------------------------------------------------------------------------------------------------|
| MEASURED VALUE | The current measured voltage from the sensor, in volts. |
| CURRENT CONDITION | The current WET , DRY , or ERR (error) condition of the sensor. ERR indicates an open or short circuit. To calibrate a leak sensor, select CAL and press Enter. After calibration, the field reverts to DRY or ERR . |
| CALIBRATION VALUE | The value saved when the sensor was last calibrated. |
| LOW LEAK THRESHOLD | The threshold value below which a leak is indicated. The threshold is based on the calibration value. |

C.3.4 Degas Pump Calibration

This screen reports the status of the vacuum degas pump calibration parameters in real time, and allows testing of the pump.

DEGAS PUMP CALIBRATION

CALIBRATE DEGAS THRESHOLD: RDY

DEGAS PRESSURE READING: nnnn

DEGAS CALIBRATION VALUE: nnnn

Help Message

Figure C-22. Degas Pump Calibration Screen

| | |
|------------------------------------------|------------------------------------------------------------------------------------------------------------------------------------------------|
| CALIBRATE DEGAS THRESHOLD | To calibrate the degas pump, select CAL and press Enter . When calibration is complete, the entry will revert to RDY . |
| DEGAS PRESSURE READING | The reading from the degas pump pressure transducer. |
| DEGAS CALIBRATION VALUE | Reports the calibration value recorded during the last calibration. |

C.3.5 Flow Calibration

This screen reports the pump flow rate calibration and provides calibration instructions.

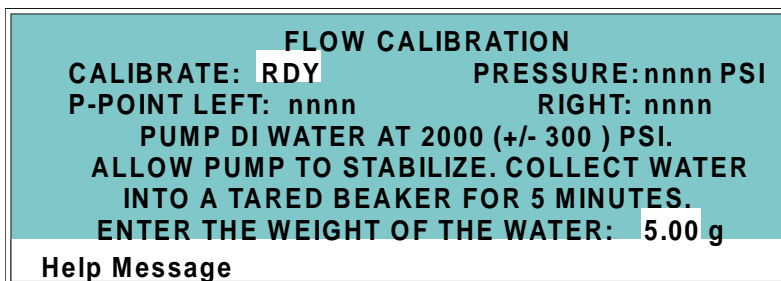

Figure C-23. Flow Calibration Screen

| Field | Description |
|--------------------------------|------------------------------------------------------------------------------------------------------------------------------------------------------------------------------------------------------------------------------------------------------------------------------------------------------------------------------------------------|
| CALIBRATE | To calibrate the flow rate, select CAL to use standard calibration parameters for pump control, or RDY to use stored parameters from the last calibration. After selecting CAL , follow the on-screen calibration instructions. It takes 5 minutes to calibrate standard heads and 20 minutes for microbore heads. |
| PRESSURE | Displays the measured value from the pressure transducer. |
| P-POINT LEFT RIGHT | Displays the pressurization points for the left and right pump pistons. When the pump has stabilized, the left and right values should be within 5. |
| WEIGHT OF THE WATER | After calibration, enter the measured weight of the water pumped into the beaker. |

C.3.6 Pressure Calibration

This screen explains how to calibrate the pump pressure and slope.

| PRESSURE CALIBRATION | | | |
|-----------------------------------------------------------------------------|----------|-----------|------------|
| OPEN PRESSURE TRANSDUCER WASTE VALVE, THEN SELECT 'OFFSET CAL' AND ENTER | | | |
| CAL MODE: | READY | SLOPE | PSI OFFSET |
| CAL VALUE: | 2500 PSI | 0.900 | + 450 |
| PRESSURE : | PSI | FLOW 1.00 | mL/MIN |
| Help Message | | | |

Figure C-24. Pressure Calibration Screen: Initial view

| Field | Description |
|-----------------------------|-----------------------------------------------------------------------------------------------------------------------------------------------------------------------------------------------------------------------------------------------------------------------------------------------|
| CAL MODE | Selects the calibration mode. READY The pump is ready for calibration. OFFSET CAL Calibrate the offset. SLOPE CAL Calibrate the slope. SLOPE DFLT Use the default slope value. EDIT Enter known correct SLOPE and OFFSET values. |
| CAL VALUE | Pressure value entered during the slope calibration procedure. Accepted values: 1 to 5000 psi, 1 to 340 bar, 0.1 to 34.0 MPa. |
| PRESSURE | Current pressure reading from the transducer. |
| SLOPE | Calibrated slope value. Accepted values: 0.7 to 1.3 (default=0.9). |
| PSI [MPa] OFFSET | Calibrated offset value. Accepted values: 200 to 1000 psi (default=450) 14 to 68 bar (default=31) 1.4 to 6.8 MPa (default=3.1) |
| FLOW | Current flow rate. |

To calibrate:

1. Stop the pump flow.
2. Go to the **PRESSURE CALIBRATION** screen.
3. Open the pressure transducer waste valve by turning it counterclockwise two turns (see Figure 2-7).
4. When the pressure reaches zero, select **OFFSET CAL** and press **Enter**. The offset calibration begins. When calibration is complete, the screen displays the following:

| PRESSURE CALIBRATION | | | |
|--------------------------------------------------------------------------|------------|-----------|------------|
| 'ENTER' TO USE SLOPE DEFAULT VALUE, OR SELECT 'SLOPE CAL' TO CONTINUE | | | |
| CAL MODE: | SLOPE DFLT | SLOPE | PSI OFFSET |
| CAL VALUE: | 2500 PSI | 0.900 | + 450 |
| PRESSURE: | 0 PSI | FLOW 1.00 | mL/MIN |
| Help Message | | | |

Figure C-25. Pressure Calibration Screen: Second View

The **PSI OFFSET** field displays the calibrated value. The **SLOPE** field does not change, but the **PRESSURE** field displays the new pressure based on the calibrated offset.

5. There are three choices for continuing the calibration:

Option 1: Save the psi offset and maintain the current slope value.

To finish the offset calibration and keep the current slope value, press **Menu** to exit the **PRESSURE CALIBRATION** screen. The new offset value will be put into effect. No slope calibration is performed.

Option 2: Save the psi offset calibration and save the default slope value.

To continue the calibration with a default slope value, press **Enter**. The **SLOPE** field displays the default slope value. The **PRESSURE** field displays the new pressure based on the calibrated offset and the default slope. The screen then returns to the initial view and calibration is complete.

Option 3: Save the psi offset calibration and calibrate the slope.

To continue to the slope calibration procedure, select **SLOPE CAL** in the **CAL MODE** field and press **Enter**. The screen displays the following:

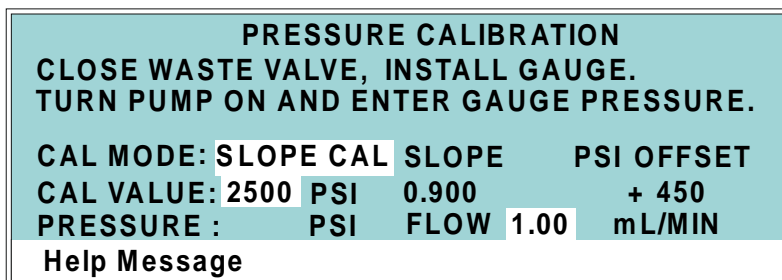

Figure C-26. Pressure Calibration Screen: Third View

6. Close the waste valve.
7. Install a pressure test gauge between the pressure transducer outlet and either a length of backpressure tubing, or a column (see Figure C-27). A pressure gauge assembly (P/N 046175), including a gauge with an accuracy rating of $\pm 0.25\%$, required fittings, and backpressure tubing, is available for this purpose. Contact Dionex for details.

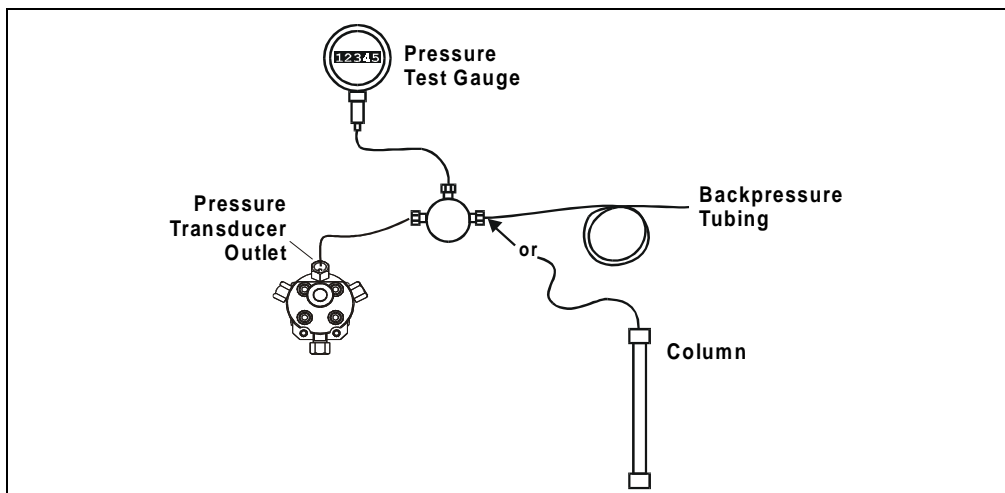

Figure C-27. Pressure Gauge Installation

8. In the **FLOW** field, enter the flow rate normally used for the application.
9. Turn on the pump. The pressure will begin increasing. Allow the pressure gauge reading to stabilize.
10. This step depends on whether backpressure tubing or a column was installed in Step 7.

Backpressure Tubing

If backpressure tubing is installed, the recommended pressure for calibration is 17.25 ± 0.17 MPa (2500 ± 25 psi). If necessary, add backpressure tubing or adjust the flow rate to bring the pressure to the recommended value. Increasing the flow rate increases the pressure; decreasing it decreases the pressure. When the gauge reading has stabilized at the recommended value, enter the reading in the **CAL VALUE** field.

Column

If a column is installed, the application flow rate and the column type determine the pressure for calibration. After allowing the gauge pressure to stabilize, enter the reading in the **CAL VALUE** field.

NOTE The pressure gauge readings may fluctuate slightly as the left and right pump heads alternate piston strokes. You can ignore variations of about ± 0.03 MPa (± 5 psi) or less. Larger fluctuations generally indicate that the pump is out of prime. If this occurs, prime the pump heads (see Section B.5) and then repeat Step 10.

11. Press **Enter**. The slope calibration begins. When calibration is complete, the screen fields display the following:
 - The **SLOPE** field displays the new slope value.
 - The **PRESSURE** field displays the same value as the **CAL VALUE**.

C.3.7 Calibrate Conductivity Cell

Follow these on-screen instructions to calibrate the conductivity cell with 1 mM KCl.

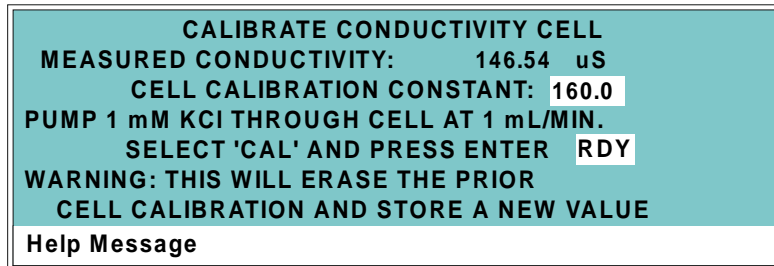

Figure C-28. Calibrate Conductivity Cell Screen

| Field | Description |
|----------------------------------|-----------------------------------------------------------------------------------------------------------------------------------------------------------------------------------------------------------------------------------------------------------------------------------------------|
| MEASURED CONDUCTIVITY | Reports the measured conductivity from the conductivity cell. |
| CELL CALIBRATION CONSTANT | Reports the current calibration constant for the cell. |
| CALIBRATE | Select CAL and press Enter to calibrate the conductivity cell to the value displayed in the conductivity field. The calibration assumes that uncontaminated 1 mM KCl is flowing through the cell at normal backpressure. The new value replaces the previous calibration value. |

D • TTL and Relay Control

The strip of eight 2-pin connectors in the IC20 electronics chassis provides two relay outputs, two TTL outputs, and four TTL inputs (see Figure D-1).

- Connect the outputs to the TTL or relay inputs of a Dionex (or non-Dionex) device to control functions of the connected device. Be sure the devices are compatible with the IC20 TTL and relay signals.
- Connect the inputs to a Dionex (or non-Dionex) device to control any four of these IC20 functions: pump/SRS on/off, method clock on/off, offset, method number increment, method number decrement, mark, and range x10. All other functions must be controlled from the IC20 front panel.

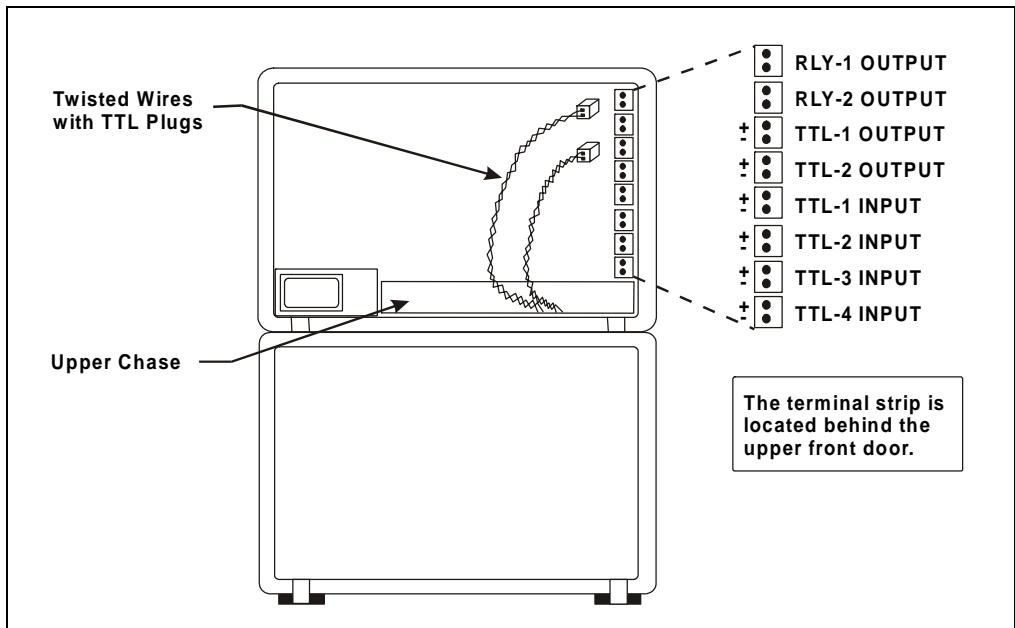

Figure D-1. TTL Connector Strip
(IC20 Front View without Upper Door)

D.1 TTL and Relay Output Operation

The IC20 provides two TTL outputs and two relay contacts to control functions in external devices such as an integrator or autosampler.

After connecting the TTL and Relay outputs (see Section D.3), toggle the output states on and off from the **DETAIL** screen (see Figure D-2) or from the **METHOD** screen (see Figure C-5 in Appendix C). Use the **DETAIL** screen to directly control the outputs and use the **METHOD** screen for timed operation of the outputs.

- To turn on a TTL or relay output, set the corresponding output field on the **MAIN** screen or **METHOD** screen to **1** (closed).
- To turn off a TTL or relay output, set the corresponding output field to **0** (open).

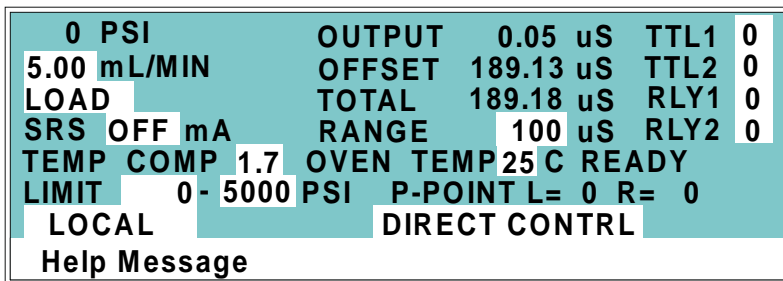

Figure D-2. Detail Screen

D.2 TTL Input Operation

The four TTL inputs can be connected to devices capable of providing TTL input signals. The signals from the connected devices can control any four of the seven functions listed below:

- **PUMP/SRS ON/OFF**
Turns the pump motor and the SRS off and on.
- **RUN METHOD**
Turns the method clock on and off. Turning off the method clock resets it to zero and executes **INIT** conditions. The method will not run unless the pump motor is already on.
- **OFFSET**
Stores the offset value. The baseline is set by subtracting this measured offset value from all subsequent measurements.
- **METHOD NUMBER INCRement**
Increases the method number by one. Each additional signal increases the method number by one more. When the method clock is zero (or **INIT**), increasing the method number executes the **INIT** conditions of the new method. When the method clock is greater than zero, increasing the method number begins running the new method at the current elapsed method clock time. This has the same result as selecting a new method number when the IC20 is in Local mode.
- **METHOD NUMBER DECRement**
Decreases the method number by one. The operation is as described under method number increment above, except that method numbers decrease instead of increase.
- **MARK**
Sends a positive pulse to the analog output (recorder) as an event marker.
- **RANGE x10**
Increases the analog output range 10 times.

D.2.1 Input Function Assignments

The functions are assigned to the TTL inputs from the **TIME FUNCTION IN** screen (see Figure D-3). The default assignments are shown. Use the **Select** buttons to change assignments if required.

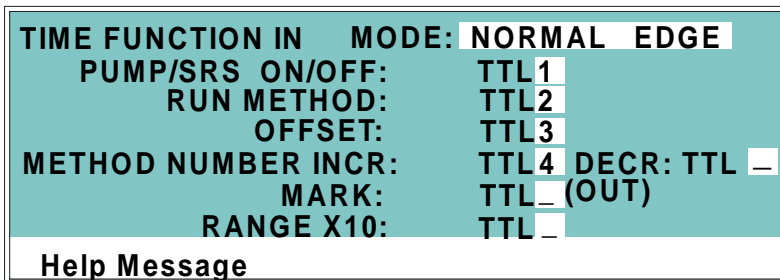

Figure D-3. Time Function In Screen

D.2.2 TTL Input Signal Modes

The TTL inputs respond to four types of signals to accommodate different types of device output signals. The default signal mode, *normal edge*, is compatible with the output signals provided by Dionex modules. If the device connected to the IC20 outputs a different signal type, select the appropriate signal mode from the **TIME FUNCTION IN** screen (see Figure D-3).

The four input signal modes are:

- *Normal Edge*: In normal edge operation, the negative (falling) edge of a signal turns on the function and the positive (rising) edge turns off the function (see Figure D-4). For example, a negative edge sent to TTL1 turns on the pump motor and a positive edge turns off the motor.
- *Inverted Edge*: The inverted edge mode works identically to the normal edge mode except that the positive and negative edges are reversed in function.
- *Normal Pulse*: In normal pulse operation, the negative (falling) edge of the TTL signal is the active edge and the positive (rising) edge is ignored. For example, applying a negative pulse to TTL1 when the pump motor is off turns the motor on. This has the same result as pressing the **Off/On** button on the front panel keypad.

The minimum pulse width guaranteed to be detected is 50 ms. The maximum pulse width guaranteed to be ignored as noise or invalid is 4 ms. The action of the IC20 is undefined for pulses less than 50 ms or greater than 4 ms.

- *Inverted Pulse*: The inverted pulse mode operates identically to the normal pulse mode, except that the positive and negative edges are reversed in function.

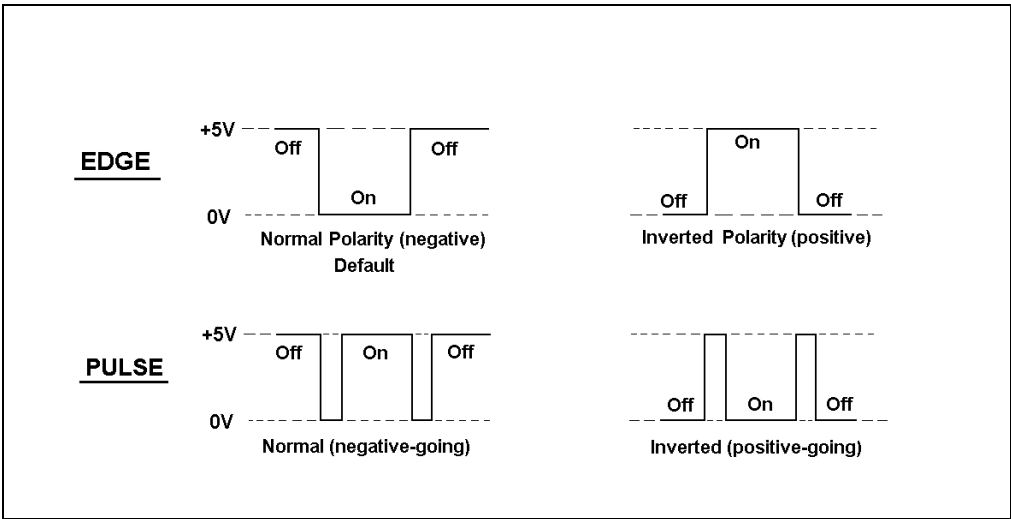

Figure D-4. TTL and Relay Input Signal Modes

D.3 TTL and Relay Connections

The TTL/relay connector strip is located on the electronics chassis behind the upper door of the IC20 (see Figure D-1). Each 2-pin connector includes a signal pin and a ground pin.

1. Twisted pairs of wires (P/N 043598) and 2-pin connector plugs (P/N 921019) are provided in the IC20 Ship Kit. Attach a 2-pin plug to each end of the twisted pair of wires to be connected. The signal wire (red) goes on top and the ground wire (black) goes on the bottom of each plug.
2. Connect these plugs to the TTL or relay connectors on the IC20 and the other module(s) as needed for the application. Check the polarity of each connection. Connect signal wires to signal (+) pins and ground wires to ground (-) pins. If necessary, remove wires from the two-pin plugs and reinsert them in the correct positions. Section D.3.1 shows example connections.
3. Route the wires from the IC20 electronics chassis through the upper chase to the rear panel.

D.3.1 Example Connections

Figure D-5 shows an example of TTL/relay connections for an IC20 connected to an AS40 Automated Sampler. Refer to the AS40 operator's manual for more information.

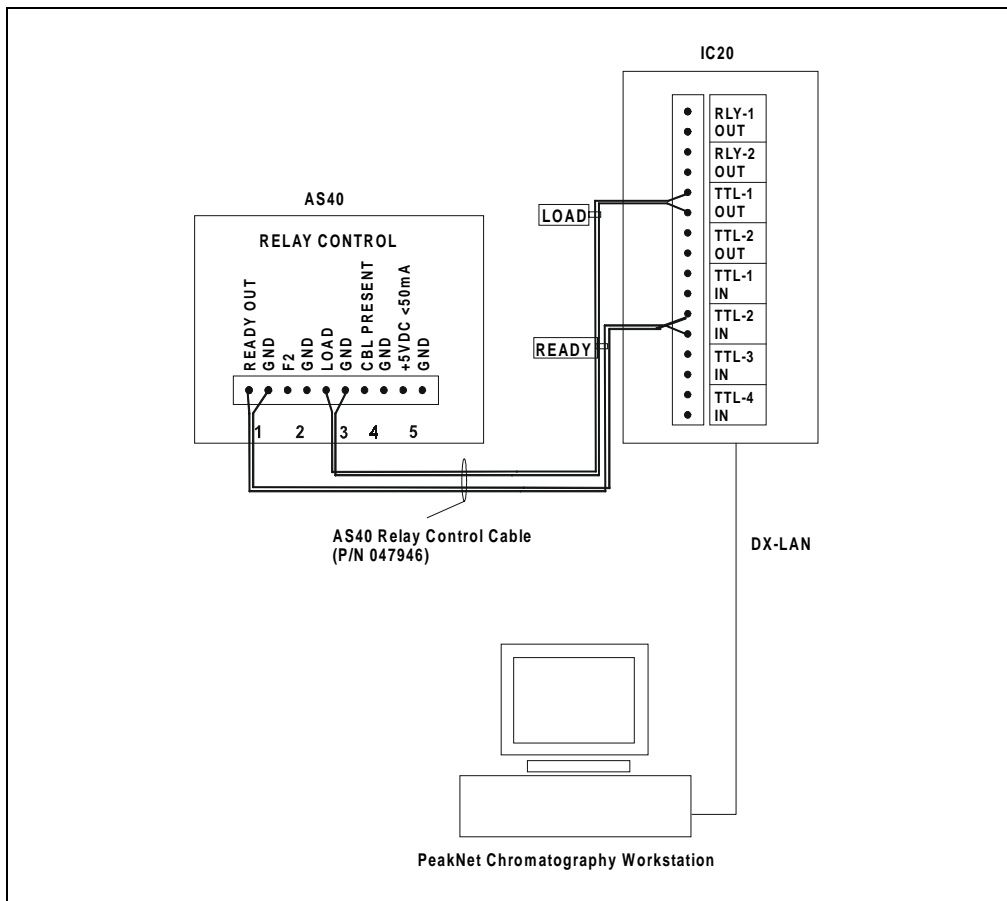

Figure D-5. Example TTL and Relay Connections: AS40

IC20 Ion Chromatograph

Figure D-6 and Figure D-7 show two different TTL/relay connections for an IC20 connected to an AS3500 Autosampler:

- Setup 1 starts running the IC20 timed events method when the autosampler makes an injection.
- Setup 2 starts running the Dionex module method before the autosampler makes an injection. The method then controls when the autosampler injection occurs.

Refer to the *PeakNet AS3500 Autosampler User's Guide* for details.

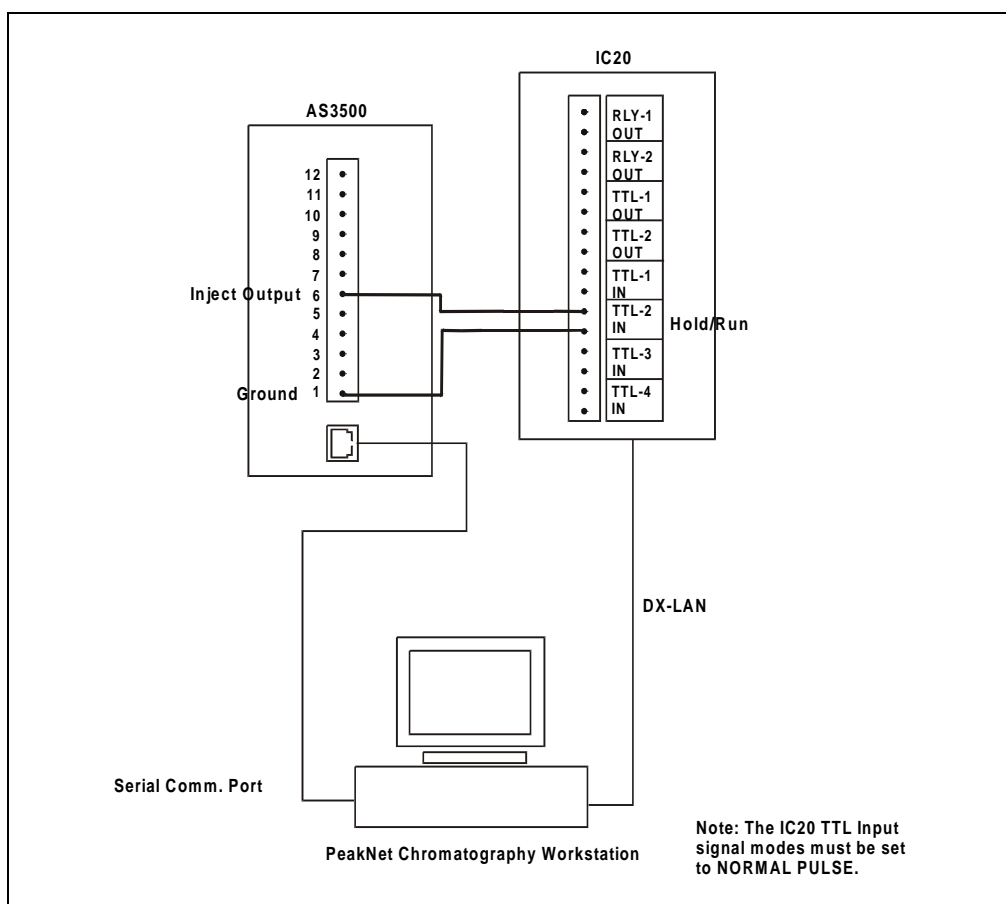

Figure D-6. Example TTL and Relay Connections: AS3500 Setup 1

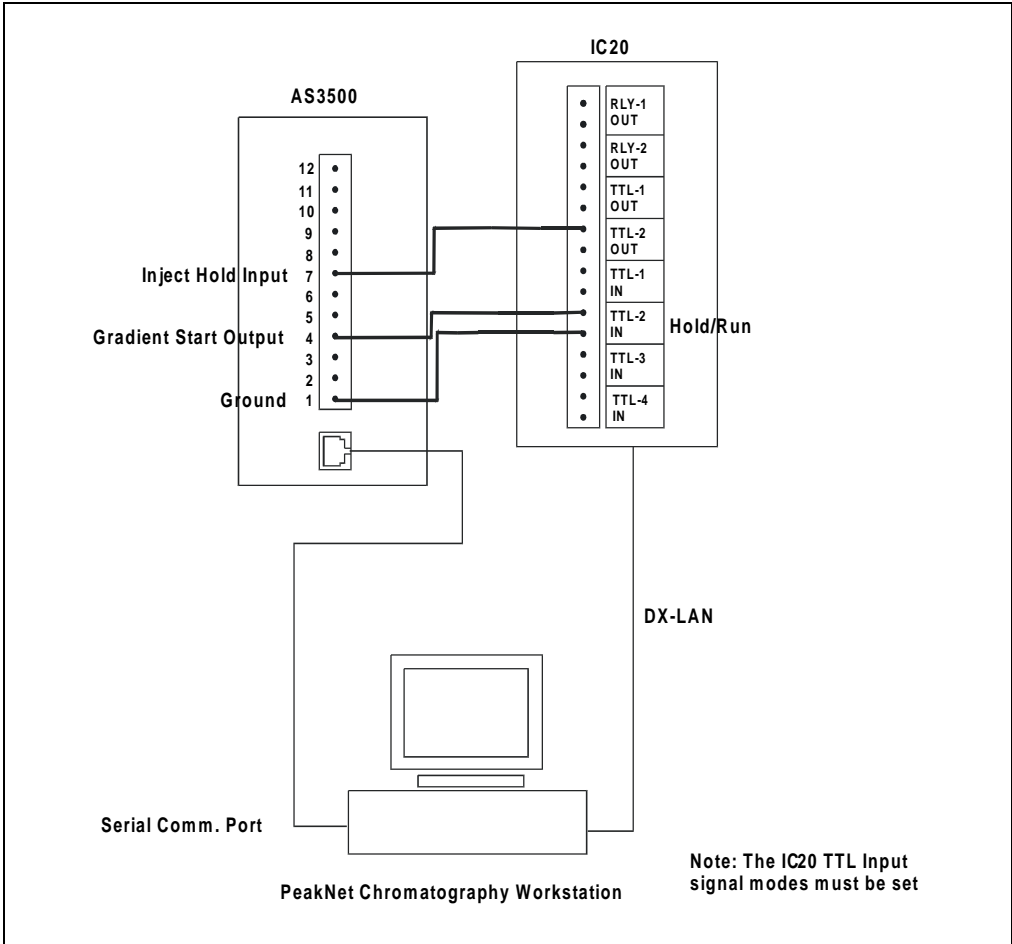

Figure D-7. Example TTL and Relay Connections:
AS3500 Setup 2

Numerics

60-pin ribbon cable, 2-10

A

Aborting a running method, 3-11
Activating button press sounds, C-8
Activating error sounds, C-8
Actuator for main power switch, 2-2
Air pressure requirements, 3-2
Analog output
 Offset level, C-13
AS40 Automated Sampler, D-7

B

Backlight, C-8
Backpressure limits, 5-11
Baseline
 Oscillations, 2-14
Blank screen, C-1
BNC Tee Connector
 Installation, B-5
Button press sound, C-8

C

Cable
 60-pin ribbon, 2-10
Cable, DX-LAN, 4-14
 Installation, B-5
 Terminator plugs, 4-14
Calibration, 2-14
Calibration Menu, C-22
 See Also Diagnostic screens
 Calibration Status, C-23

Degas Pump Calibration, C-31
Degas Status, C-25
Flow Calibration, C-26
Leak Sensor Calibration and Status, C-24
Pressure Calibration, C-27
Calibration screens, C-22
Calibration Status screen, C-23
Cell
 See Conductivity cell
Check valve
 Cleaning, 5-2
Circuit boards, 2-7
 CPU, 2-10
 DX-LAN, 2-10
 Relay I/O, 2-10
Circuitry, A/D, C-19
Clock
 See Method clock
Column switching valve
 Selecting, C-4
Conductivity cell, 2-14
 Air bubble removal, 5-11
 Backpressure limits, 5-11
 Benefits, 2-14
 Calibration, 2-14, C-31
 Calibration constant, 5-12
 Calibration procedure, 5-12
 Specifications, A-2
Conductivity detection
 Temperature variations, 2-14
Connectors
 Electronics chassis, 2-7
 LC Air valves, 2-8
 LC Leak, 2-8
 TTL/Relay control, 2-8
Contrast, 2-2
Control modes, 2-18
 Direct, 2-18

- Method, 2-18, 2-20
 - Selecting, 2-18
- Control panel, 2-2
 - Keypad, 2-3
- Conventions, 1-3
- CPU circuit board, 2-10
- Creating a method, 3-7

D

- Daily maintenance, 3-12
- Degas Options screen, C-11
- Degas Pump Calibration screen, C-31
- Degas Status screen, C-25
- Degas vacuum pump, 2-15
- Deleting a method, 3-11
- Description
 - Calibration screens, C-22
 - Diagnostic screens, C-14
 - Functional, 2-17
 - Modes of operation, 2-19
 - Operational screens, C-3
 - Physical, 2-1
 - TTL input control, D-3
- Detector specifications, A-2
- Diagnostic menu, C-14
- Diagnostic screens, C-14
 - See Also* Calibration Menu
 - Degas Status, C-25
 - Diagnostic menu, C-14
 - Diagnostic Test, C-20
 - DSP Code Version, C-22
 - Elapsed Time, C-16
 - Keyboard Test, C-18
 - Leak Status, C-24
 - Power-Up screen, C-15
 - Pressure Calibration, C-27
- Diagnostic Test screen, C-20
- Digital Signal Processor (DSP), 1-1
- Direct control mode, 2-18, 3-4
 - Relay assignments, C-5
 - TTL assignments, C-5
- Display and keypad specifications, A-1

- Display screens, 2-6
 - Backlight, C-8
 - Calibration Status, C-23
 - Degas Options, C-11
 - Degas Pump Calibration, C-31
 - Degas Status, C-25
 - Diagnostic menu, C-14
 - Diagnostic screens, C-14, C-22
 - Diagnostic Test, C-20
 - DSP Code Version, C-22
 - Elapsed Time, C-16
 - Leak Status, C-24
 - Main status, C-3
 - Menu of Screens, C-2
 - Method edit, C-6
 - Module Setup screen, C-8
 - Power-Up, 2-6, 3-3, C-15
 - Pressure Calibration, C-27
 - Time Function In, C-10
- DSP card
 - Troubleshooting, 4-7
- DX-LAN
 - Card, 2-10, B-4
 - Remote control, 2-19
- DX-LAN cable
 - Installation, B-5
- DX-LAN connector, 4-14
- DX-LAN interface card
 - Installation, B-4
- DX-LAN network
 - Installation, B-4
 - Problems, 4-14

E

- E01 Eluent Organizers, 2-16
- Edge input signal mode, D-4
- Editing a method, 3-10
- Elapsed Time screen, C-16
- Electrical specifications, A-1
- Electronics
 - Testing, C-19
- Electronics chassis, 2-7

- Connections, B-7
 - CPU, 2-10
 - TTL/Relay connections, D-6
 - TTL/Relay connectors, 2-8
- Eluent
- Conductivity suppression, 2-14
 - Connecting lines to pump, B-8
 - Outlet line connections, B-8
 - Priming the lines, B-9
- Eluent Flow Schematic, 2-12
- Eluent selection valve, 1-1, 2-20
- End-line filter, 3-2
- Entry error sounds, C-8
- Environmental specifications, A-1
- Error messages
- Degas vacuum pump not present, 4-9
 - DSP ..., 4-5
 - Encoder index not found, 4-6
 - High pressure limit violation, 4-5
 - Low pressure limit violation, 4-4, C-12
 - Low Vacuum Alarm, 4-10
 - Motor drive fails, 4-6
 - TTL2 is set to indicate Flow/No Flow, 4-10
 - Vacuum degas fails, 4-9
- F**
- Facilities required, B-1
- Ferrule fittings, 4-12, 5-11
- Filter, end-line, 3-2
- Flow Calibration screen, C-26
- Flow column, on Method screen, 3-6
- Flow rate
- Ranges, 2-11
 - Stabilizing, 3-6
- Front panel, 2-2
- Display screens, 2-6
 - Keypad, 2-3
 - Tilting, 2-2
- Functional description, 2-17
- Method control, 2-20
 - Modes of operation, 2-19
 - TTL input, D-3
- Fuses, A-1
- Replacing, 5-10
- G**
- Generating a method, 3-7
- H**
- Host computer, 2-19
- Humidity, operating, A-1
- Hydraulic specifications, A-2
- I**
- IC20
- Versions, 1-1
- Initial conditions, 2-4
- Injection valve, 2-8
- Controlling position of, C-3
- Installation, B-1
- BNC tee connector, B-5
 - CPU, 2-10
 - DX-LAN network, B-4–B-5
 - Eluent line connections to pump, B-8
 - Eluent outlet line, B-8
 - Eluent reservoirs, 2-16
 - Facilities required, B-1
 - LC25 communication, B-7
 - Power connection, B-2
 - Priming the eluent inlet lines, B-9
 - Rear panel, 2-16
 - Setting pressure limits, 3-4
 - TTL/Relay connections, D-6
 - Waste line, B-3
- Interior components, 2-11
- Inverted edge, D-4
- Inverted pulse, D-5

K

- Keyboard Test screen, C-18
- Keypad buttons, 2-3
 - Button press sound, C-8

L

- LC25 Chromatography Oven, 2-8, 2-14
 - Set point, 2-9
 - Temperature range, 1-1
 - Temperature selection, C-3
 - Temperature selection guidelines, 3-3
- Leak alarm, 4-6
- Leak sensor calibration, C-24
- Leak status screen, C-24
- Leaks, liquid, 5-11
- Left/right pressurization points, C-21
- Limit field
 - Method screen, C-7
 - Selecting pressure limits, 3-4
- Liquid crystal display (LCD)
 - Adjusting the screen contrast, 2-2
- Liquid leaks, 4-6
- Liquid lines, 5-2
- Local mode, 2-17, 2-19, C-4
- Locked Remote mode, 2-19, C-4

M

- Main status screen, C-3
- Maintenance
 - Daily, 3-12
 - Periodic, 3-14
 - Replacing piston seals, 3-14
 - Routine maintenance, 3-12
- Mechanical chassis, 2-11
- Menu of Screens, C-2
- Menu structure chart, C-1
- Method clock, 2-20
 - Controlling, 3-9
 - Holding (pausing), 2-4
 - Resetting, 2-4

- Starting a method, 3-9
- Method control, 2-18, 3-6
- Method edit screen, C-6
- Method steps
 - Definition, 2-20
 - Deleting, 3-10
 - Entering, 3-6, C-6
 - Inserting, 3-8
 - Maximum number allowed, 2-20
- Methods
 - Aborting a running method, 3-11
 - Control, 3-6
 - Creating, 3-7
 - Deleting a method, 3-11
 - Deleting a step, 3-10
 - Editing, 3-10
 - Number allowed, 2-20
 - Running a method, 3-9
- Modes of operation
 - See* Operating modes
- Module Setup screen, C-8
- Moduleware, 2-10

N

- Normal edge, D-4
- Normal pulse, D-4

O

- Offset calibration, C-27
- Operating configuration
 - TTL input, D-3
- Operating modes
 - Direct control, 2-18, 3-4
 - Local mode, 2-17, 2-19
 - Locked Remote mode, 2-19, C-4
 - Method control, 2-20
 - Remote mode, 2-17, 2-19
 - Selecting, 2-17
 - TTL input, 2-17
- Operation, 3-1

- Aborting a running method, 3-11
- Creating a method, 3-7
- Deleting a method, 3-11
- Editing a method, 3-10
- INIT conditions, 3-7
- Method control, 3-6
- Preparing to run, 3-1
- Running a method, 3-9
- Selecting pressure limits, 3-4
- Shutdown, 3-12
- Operational screens, C-3

P

- Pausing the method clock, 2-4
- PEEK liquid lines, 5-2
- Periodic maintenance, 3-14
- Physical description
 - Control panel, 2-3
 - Display screens, 2-6
 - Layout, 2-2
 - Pressure transducer, 2-13
 - Pump priming block, 2-13
 - Rear panel, 2-16
 - Vacuum degas assembly, 2-15
- Physical description, 2-1
- Physical specifications, A-1
- Piston replacement, 5-8
- Piston seal replacement, 5-4
- Piston volume, 2-11
- Power
 - Requirements, A-1
- Power supply, 2-10
- Power switches, 2-2
- Power-Up screen, 2-6, 3-3, C-15
- Pressure Calibration screen, C-27
- Pressure limits, 3-4, C-7
- Pressure transducer, 2-13
 - Assembly drawing, 5-8
 - Waste valve, B-11
- Pressure, operating, 2-11
- Pressurization points, C-21
- Priming

- Eluent lines, B-9
- Pump out of prime, 4-1
- Priming block, 2-13
- Pulse input signal mode, D-4
- Pump heads
 - Assembly drawing, 5-4
- Pump priming block, 2-13

R

- Rear panel, 2-16
- Recorders
 - Analog output setting, C-13
- Regulator, gas supply, 3-2
- Relay connectors, 2-8
 - See Also* TTL/Relay control, 2-8
- Relay control
 - Turning on/off, C-5
- Relief valve, B-11
- Remote mode, 2-19, C-4
- Rinsing the pump heads, 3-12
- Rise time, C-13
- Routine maintenance, 3-12
- Running a method, 3-9

S

- Safety messages, 1-3
- Safety standards, 1-3
- Save To field
 - Method screen, C-6
- Screen brightness, C-8
- Screen contrast, 2-2
- Screens
 - See* Display screens
- Seal replacement, 5-4
- Self-Regenerating Suppressor (SRS), B-13
 - Automatic shut off, B-13
 - Power supply specifications, A-3
- Service
 - Check valves, 5-2
 - Fuses, 5-10

- Piston seal, 5-4
- Pump piston, 5-8
- Waste valve O-ring, 5-9
- Service procedures
 - Conductivity cell calibration, 5-12
 - Removing air from the conductivity cell, 5-11
- Setting pressure limits, 3-4
- Shutdown, 3-12
- Signal modes for TTL input, D-4
- Specifications
 - Display and keypad, A-1
 - Electrical, A-1
 - Environmental, A-1
 - Hydraulic, A-2
 - Physical, A-1
 - Vacuum degas assembly, A-3
- SRS, B-13
 - See* Self-Regenerating Suppressor (SRS)
- Stabilization time for flow rates, 3-6
- System outlet line, B-8

T

- Tee connector, 4-14
- Temperature
 - Minimizing the effect of variations, 2-14
- Temperature compensation, 2-14
 - Optimizing, 3-11
- Temperature compensation factor
 - Selection, C-5
- Temperature, operating, A-1
- Tests
 - Diagnostic, C-20
 - Keyboard, C-18
 - Pressure transducer, C-21
 - Vacuum degas pump, C-25
- Tilting the front panel, 2-2
- Time
 - Pump, seals, backlight in use, C-16
 - Setting the clock, 3-9
- Time Function In screen, C-10, D-4
- Time-based steps, entering, 3-6

- Transducer, 2-13
- Troubleshooting, 4-1
 - Cell constant reading inaccurate, 4-13
 - Chromatographic reproducibility, 4-11
 - Degas vacuum pump calibration, 4-9
 - DX-LAN communication, 4-14
 - High detector output, 4-12
 - Leak alarm, 4-6
 - Liquid leaks, 4-6
 - Low detector output, 4-12
 - No detector response, 4-11
 - Noisy baseline, 4-12
 - Noisy pump motor, 4-7
 - Pump head pressure fluctuations, 4-1
 - Pump out of prime, 4-1
 - Pump stops, 4-3
 - Pump will not start, 4-3
 - Relay control functions, 4-10
- TTL/Relay control, 2-17, D-1
 - Connectors, D-1
 - Example connections, D-7
 - Input operation, D-3
 - Input signal modes, D-4
 - Installation, D-6
 - Output operation, D-1
 - Turning on/off, C-5
- TTL/Relay control connections, 2-8
- TTL2 output usage, B-13
- Type of control, 2-20
 - Method control, 2-20

U

- User interface screens
 - See* Display screens

V

- V (valve) column on Method screen, 3-6, C-7
- Vacuum degas assembly, 1-1, 2-15
 - Specifications, A-3
- Valves

Check valves, 5-2
Column switching, C-4
Injection, C-3
Voltage, full-scale, C-13

W

Waste line installation, B-3
Waste valve, B-11

