



012

Scheren
Scissors
Tijeras
Forbici





012

Chirurgische Scheren
Surgical Scissors
Tijeras para cirugía
Forbici per chirurgia

gerade • straight • rectas • retto



STANDARD

012-100-105	10,5 cm / 4 1/4"
012-100-115	11,5 cm / 4 1/2"
012-100-130	13,0 cm / 5 1/8"
012-100-145	14,5 cm / 5 3/4"
012-100-155	15,5 cm / 6"
012-100-165	16,5 cm / 6 1/2"
012-100-175	17,5 cm / 7"
012-100-185	18,5 cm / 7 1/4"
012-100-200	20,0 cm / 8"



STANDARD

012-102-105	10,5 cm / 4 1/4"
012-102-115	11,5 cm / 4 1/2"
012-102-130	13,0 cm / 5 1/8"
012-102-145	14,5 cm / 5 3/4"
012-102-155	15,5 cm / 6"
012-102-165	16,5 cm / 6 1/2"
012-102-175	17,5 cm / 7"
012-102-185	18,5 cm / 7 1/4"
012-102-200	20,0 cm / 8"



STANDARD

012-104-105	10,5 cm / 4 1/4"
012-104-115	11,5 cm / 4 1/2"
012-104-130	13,0 cm / 5 1/8"
012-104-145	14,5 cm / 5 3/4"
012-104-155	15,5 cm / 6"
012-104-165	16,5 cm / 6 1/2"
012-104-175	17,5 cm / 7"
012-104-185	18,5 cm / 7 1/4"
012-104-200	20,0 cm / 8"

gebogen • curved • curvas • curve



STANDARD

012-101-115	11,5 cm / 4 1/2"
012-101-130	13,0 cm / 5 1/8"
012-101-145	14,5 cm / 5 3/4"
012-101-155	15,5 cm / 6"
012-101-165	16,5 cm / 6 1/2"
012-101-175	17,5 cm / 7"
012-101-185	18,5 cm / 7 1/4"
012-101-200	20,0 cm / 8"



STANDARD

012-103-115	11,5 cm / 4 1/2"
012-103-130	13,0 cm / 5 1/8"
012-103-145	14,5 cm / 5 3/4"
012-103-155	15,5 cm / 6"
012-103-165	16,5 cm / 6 1/2"
012-103-175	17,5 cm / 7"
012-103-185	18,5 cm / 7 1/4"
012-103-200	20,0 cm / 8"



STANDARD

012-105-115	11,5 cm / 4 1/2"
012-105-130	13,0 cm / 5 1/8"
012-105-145	14,5 cm / 5 3/4"
012-105-155	15,5 cm / 6"
012-105-165	16,5 cm / 6 1/2"
012-105-175	17,5 cm / 7"
012-105-185	18,5 cm / 7 1/4"
012-105-200	20,0 cm / 8"



012

Chirurgische Scheren
Surgical Scissors
Tijeras para cirugía
Forbici per chirurgia



GRAZIL

012-110-130 13,0 cm / 5¹/₈"
012-110-145 14,5 cm / 5³/₄"



GRAZIL

012-111-130 13,0 cm / 5¹/₈"
012-111-145 14,5 cm / 5³/₄"



GRAZIL

012-112-130 13,0 cm / 5¹/₈"
012-112-145 14,5 cm / 5³/₄"



GRAZIL

012-113-130 13,0 cm / 5¹/₈"
012-113-145 14,5 cm / 5³/₄"



GRAZIL

012-114-130 13,0 cm / 5¹/₈"
012-114-145 14,5 cm / 5³/₄"



GRAZIL

012-115-130 13,0 cm / 5¹/₈"
012-115-145 14,5 cm / 5³/₄"



INCISION

- 012-120-130** 13,0 cm / 5 1/8"
- 012-120-145** 14,5 cm / 5 3/4"



DEAVER

- 012-130-140** 14,0 cm / 5 1/2"

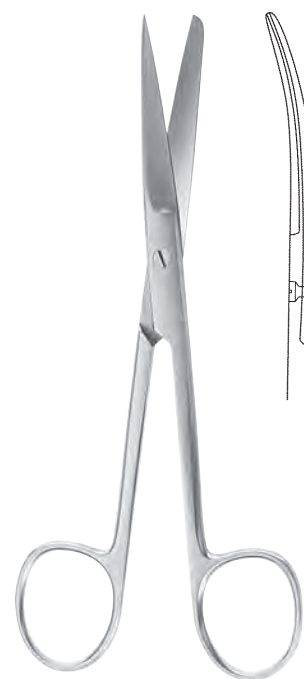

DEAVER

- 012-131-140** 14,0 cm / 5 1/2"

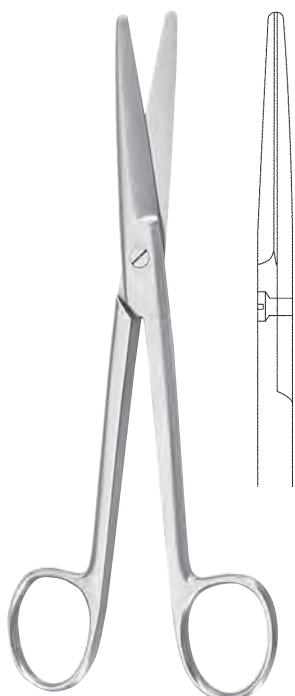

MAYO

- 012-140-145** 14,5 cm / 5 3/4"
- 012-140-155** 15,5 cm / 6"
- 012-140-170** 17,0 cm / 6 3/4"
- 012-140-230** 23,0 cm / 9"

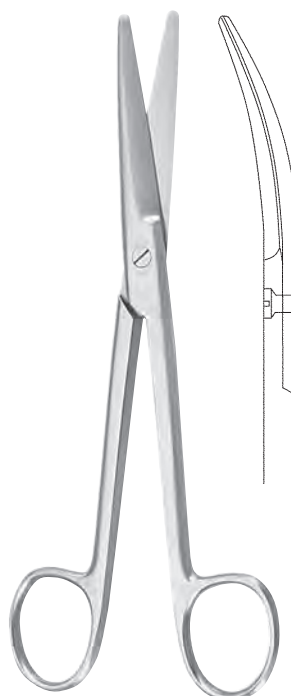

MAYO

- 012-141-145** 14,5 cm / 5 3/4"
- 012-141-155** 15,5 cm / 6"
- 012-141-170** 17,0 cm / 6 3/4"
- 012-141-230** 23,0 cm / 9"



012

Chirurgische Scheren
Surgical Scissors
Tijeras para cirugía
Forbici per chirurgia

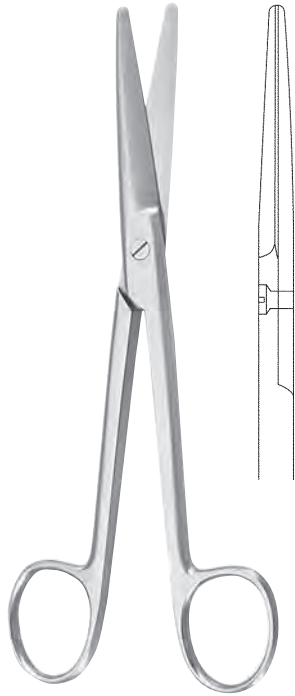

MAYO-HARRINGTON

012-142-225 22,5 cm / 9"

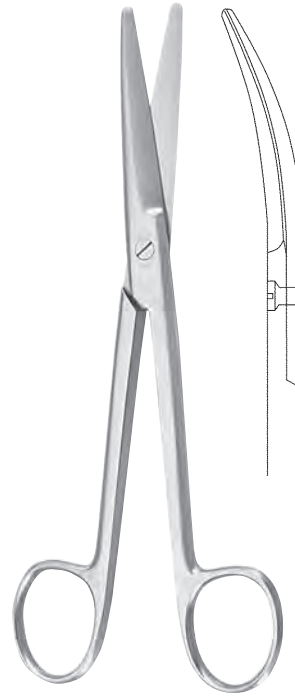

MAYO-HARRINGTON

012-143-225 22,5 cm / 9"
012-143-280 28,0 cm / 11"

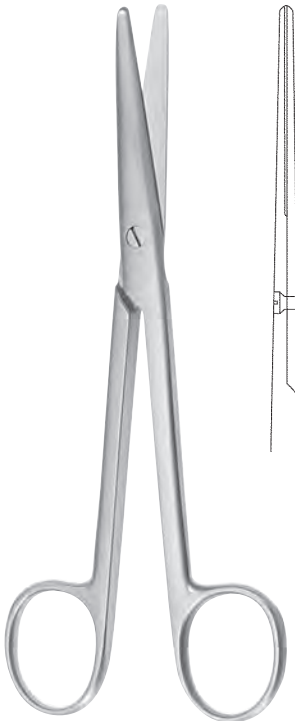

MAYO-STILLE

012-150-150 15,0 cm / 6"
012-150-170 17,0 cm / 6³/₄"
012-150-190 19,0 cm / 7¹/₂"



MAYO-STILLE

012-151-150 15,0 cm / 6"
012-151-170 17,0 cm / 6³/₄"
012-151-190 19,0 cm / 7¹/₂"



MAYO-NOBLE

012-154-170 17,0 cm / 6³/₄"

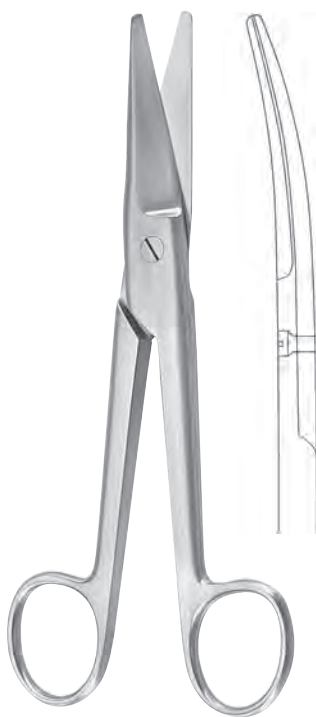

MAYO-NOBLE

012-155-170 17,0 cm / 6³/₄"

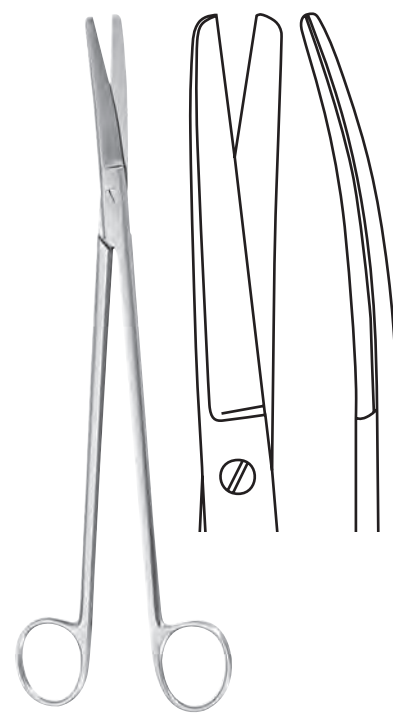

WERTHEIM

012-159-145 14,5 cm / 5¹/₂"
012-159-195 19,5 cm / 7³/₄"
012-159-225 22,5 cm / 9"

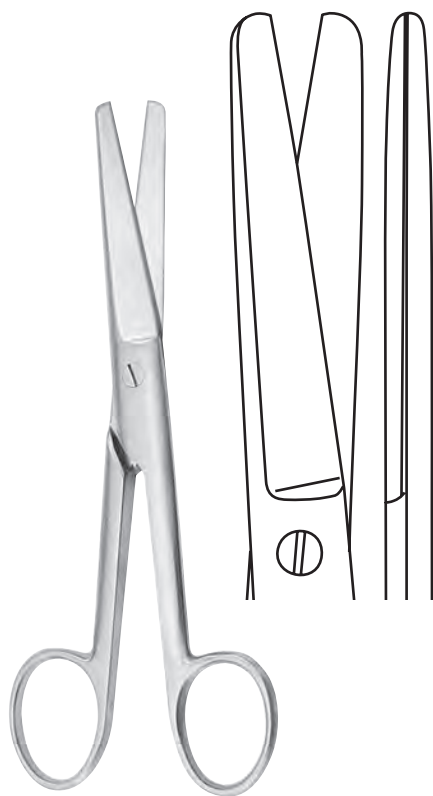

DOYEN

012-160-175 17,5 cm / 7"

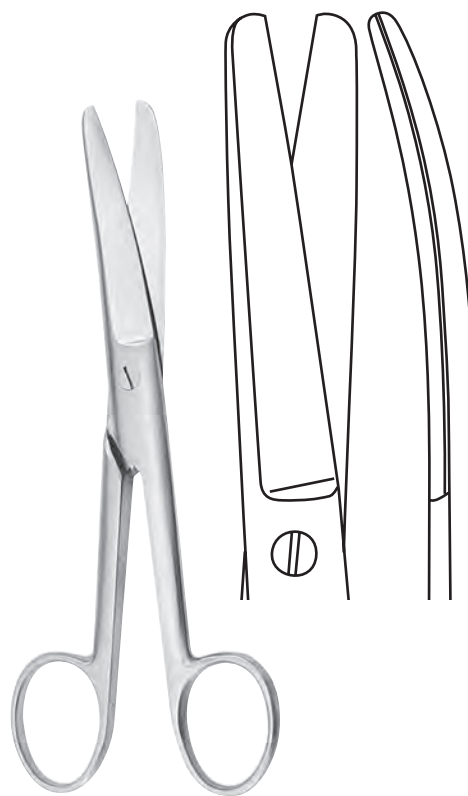

DOYEN

012-161-175 17,5 cm / 7"



012

Gynäkologische Scheren
Gynecological Scissors
Tijeras para ginecología
Forbici per ginecologia

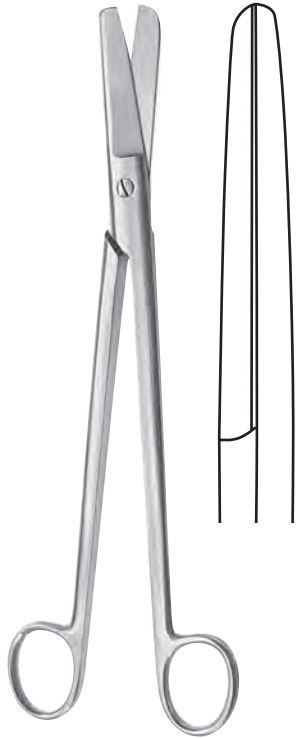

DUBOIS

012-160-270 27,0 cm / 10⁵/₈"

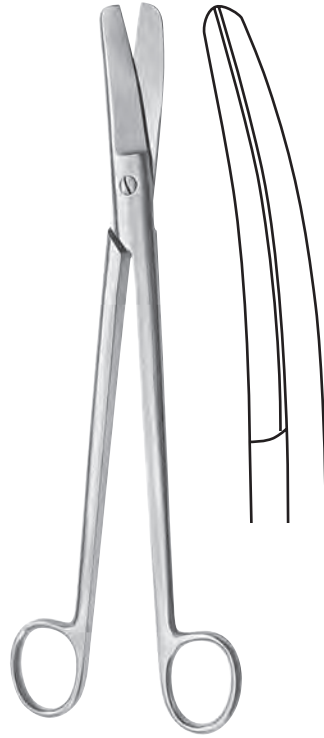

DUBOIS

012-161-270 27,0 cm / 10⁵/₈"



BOZEMANN

012-163-220 22,0 cm / 8³/₄"



SIEBOLD

012-165-240 24,0 cm / 9¹/₂"

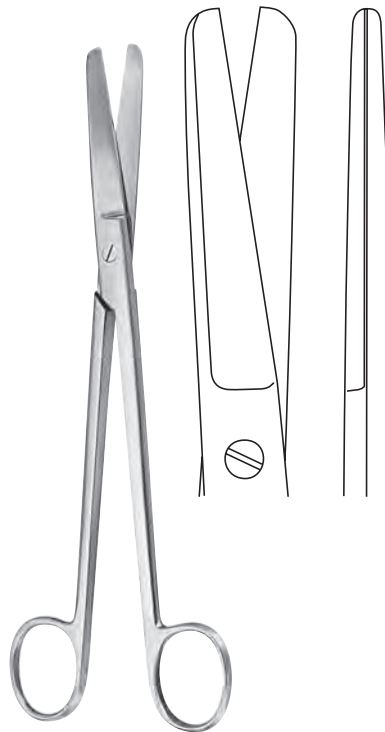

SIMS

012-166-200 20,0 cm / 8"
012-166-230 23,0 cm / 9"

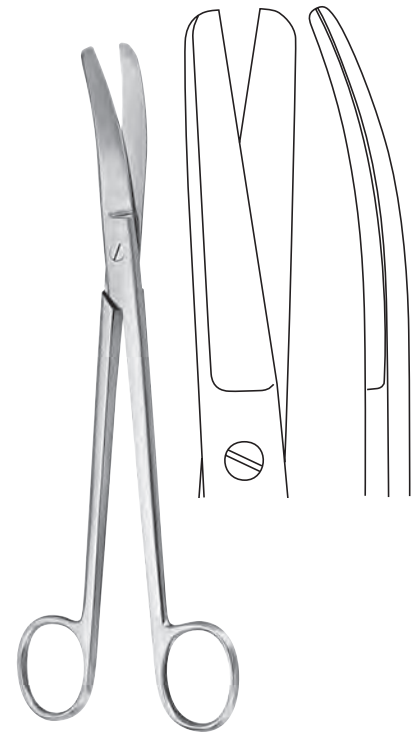

SIMS

012-167-200 20,0 cm / 8"
012-167-230 23,0 cm / 9"



BRAUN-STADLER

012-169-140 14,0 cm / 5 1/2"
012-169-220 22,0 cm / 8 3/4"



BUSCH

012-171-130 13,0 cm / 5 1/8"
012-171-160 16,0 cm / 6 1/4"



MOD. USA

012-173-105 10,5 cm / 4 1/8"



SCHUMACHER

012-175-160 16,0 cm / 6 1/4"



WALDMANN

012-177-180 18,0 cm / 7"



012-179-200 20,0 cm / 8"

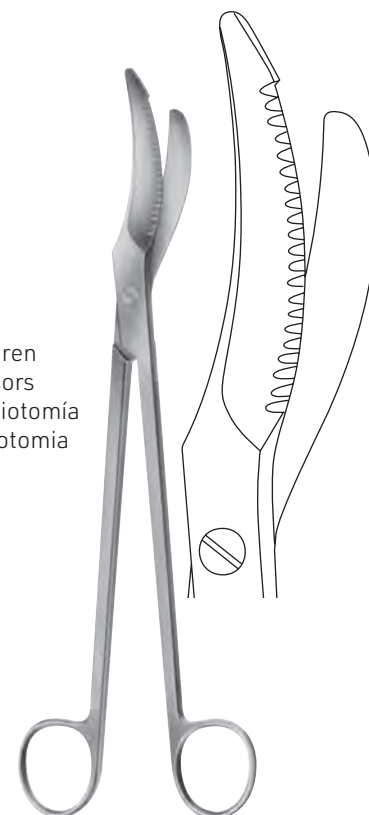

012-181-240 24,0 cm / 9 1/2"

Episiotomiescheren
 Episiotomy scissors
 Tijeras para episiotomía
 Forbici per episiotomia

Episiotomiescheren
 Episiotomy scissors
 Tijeras para episiotomía
 Forbici per episiotomia

gezahnt
 toothed
 dentada
 dentate



012

Präparierscheren
Dissecting Scissors
Tijeras de disección
Forbici per dissezione



METZENBAUM-BABY

012-200-115 11,5 cm / 4 1/2"



METZENBAUM-BABY

012-201-115 11,5 cm / 4 1/2"



METZENBAUM

012-202-145 - 012-203-145 14,5 cm / 5 1/2"

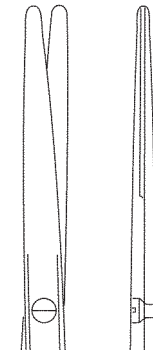

012-202-145

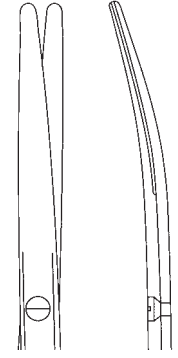

012-203-145



METZENBAUM

012-204-145 - 012-205-145 14,5 cm / 5 1/2"



012-204-145

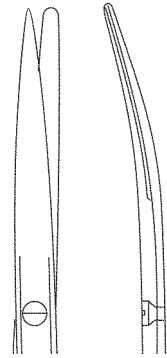

012-205-145



METZENBAUM

012-206-145 - 012-207-145 14,5 cm / 5 1/2"

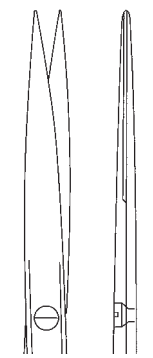

012-206-145



012-207-145



METZENBAUM-NELSON

012-210-180	18,0 cm / 7"
012-210-200	20,0 cm / 8"
012-210-230	23,0 cm / 9"
012-210-250	25,0 cm / 10"
012-210-280	28,0 cm / 11"
012-210-300	30,0 cm / 12"



METZENBAUM-NELSON

012-211-180	18,0 cm / 7"
012-211-200	20,0 cm / 8"
012-211-230	23,0 cm / 9"
012-211-250	25,0 cm / 10"
012-211-280	28,0 cm / 11"
012-211-300	30,0 cm / 12"



012

Präparierscheren
Dissecting Scissors
Tijeras de disección
Forbici per dissezione

Nerv-Präparierscheren • Nerve-Dissecting Scissors
Tijeras para disección de nervios • Forbici per nervi



012-214-150 15,0 cm / 6"



012-215-150 15,0 cm / 6"

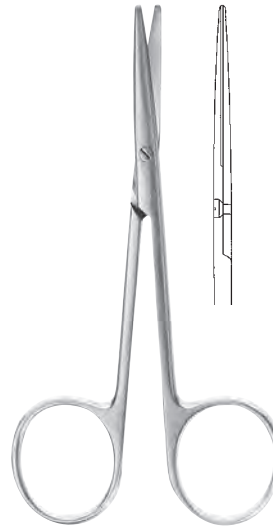

LEXER-BABY
012-220-100 10,0 cm / 4"

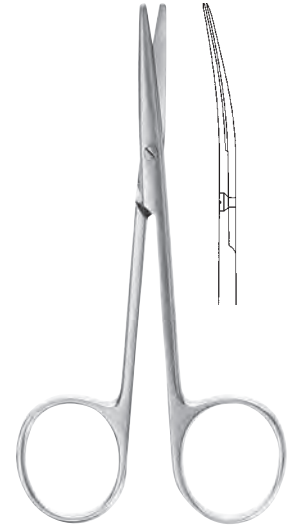

LEXER-BABY
012-221-100 10,0 cm / 4"



LEXER
012-220-160 16,0 cm / 6 1/4"
012-220-210 21,0 cm / 8 1/4"



LEXER
012-221-160 16,0 cm / 6 1/4"
012-221-210 21,0 cm / 8 1/4"

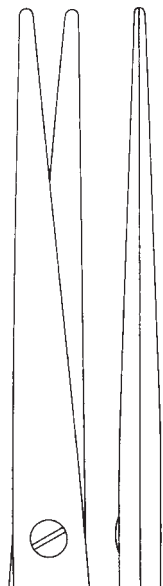

012-230-160



012-231-160

LEXER-FINO

012-230-160 – 012-231-160 16,0 cm / 6¹/₄"

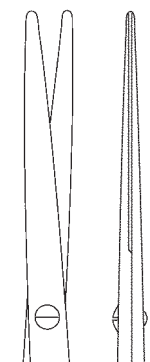

012-240-145

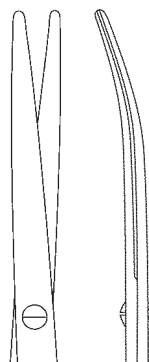

012-241-145

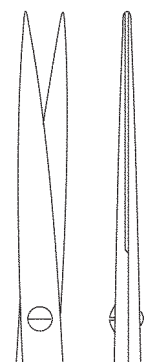

012-242-145

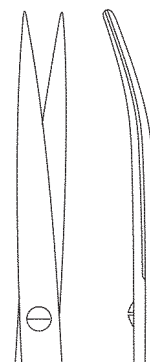

012-243-145

METZENBAUM-FINO

012-240-145 – 012-241-145 14,5 cm / 5³/₄"

METZENBAUM-FINO

012-242-145 – 012-243-145 14,5 cm / 5³/₄"



012

Präparierscheren
Dissecting Scissors
Tijeras para disección
Forbici per dissezione

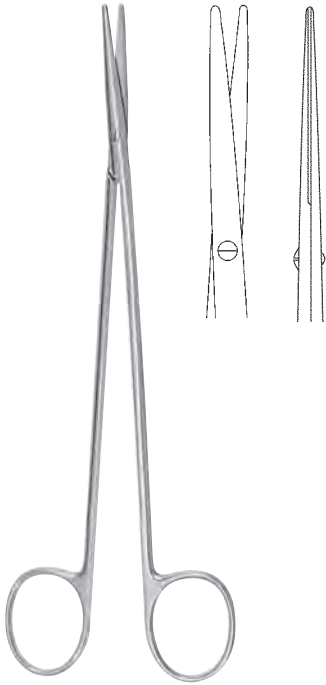

METZENBAUM-FINO

- 012-244-180** 18,0 cm / 7"
- 012-244-200** 20,0 cm / 8"
- 012-244-230** 23,0 cm / 9"

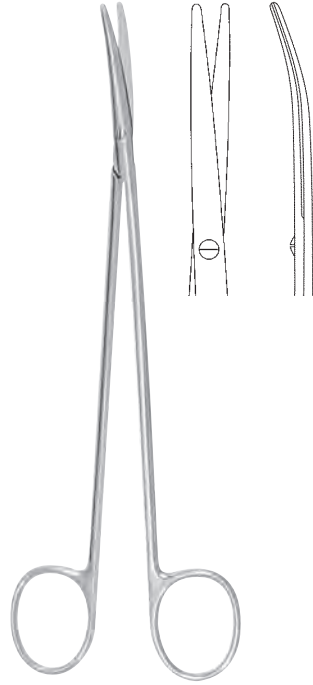

METZENBAUM-FINO

- 012-245-180** 18,0 cm / 7"
- 012-245-200** 20,0 cm / 8"
- 012-245-230** 23,0 cm / 9"

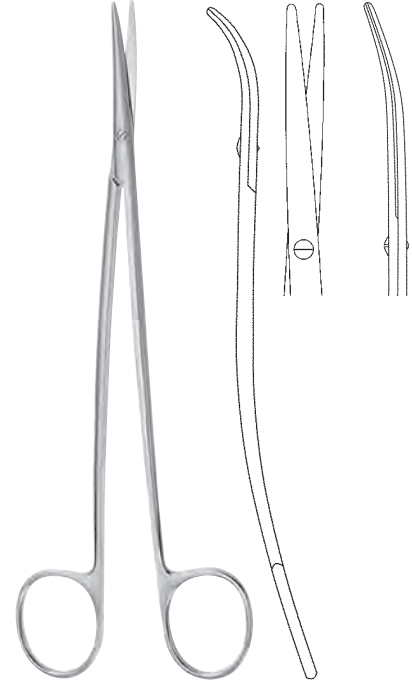

METZENBAUM-FINO S

- 012-247-180** 18,0 cm / 7"
- 012-247-200** 20,0 cm / 8"
- 012-247-230** 23,0 cm / 9"



THOREK

- 012-251-190** 19,0 cm / 7 1/2"

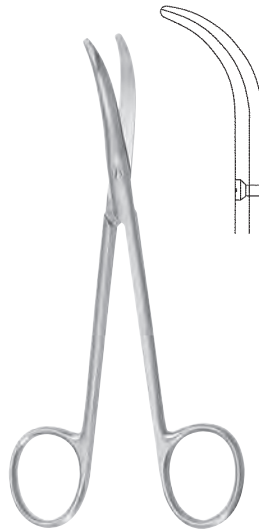

FOMON

- 012-253-135** 13,5 cm / 5 1/8"



ENUCLEATION

- 012-255-110** 11,0 cm / 4 3/8"



LANDOLT

012-257-125 12,5 cm / 5"



LANDOLT

012-259-125 12,5 cm / 5"



KILNER

012-261-120 12,0 cm / 4³/₄"
012-261-150 15,0 cm / 6"



JOSEPH

012-262-140 14,0 cm / 5¹/₂"

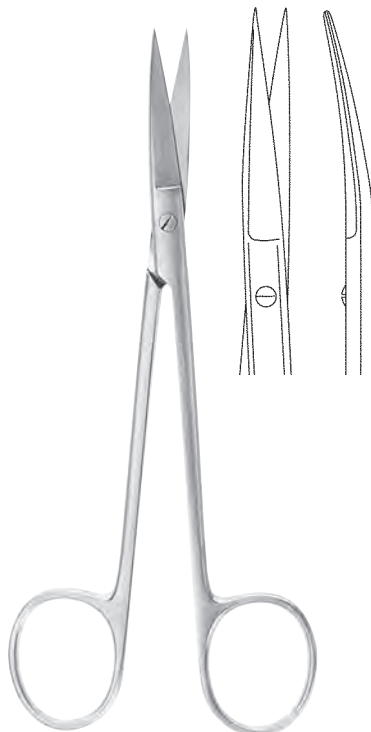

JOSEPH

012-263-140 14,0 cm / 5¹/₂"



012

Feine chirurgische Scheren
Delicate Surgical Scissors
Tijeras finas para cirugía
Forbici fine per chirurgia



BROPHY-SULLIVAN

012-264-140 14,0 cm / 5 1/2"



BROPHY-SULLIVAN

012-265-140 14,0 cm / 5 1/2"

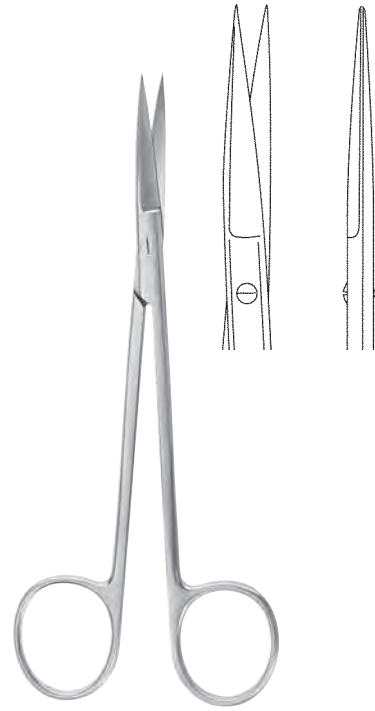

SANVENERO

012-266-140 14,0 cm / 5 1/2"

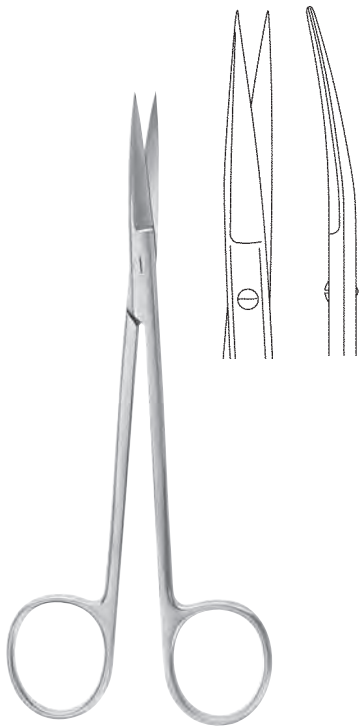

SANVENERO

012-267-140 14,0 cm / 5 1/2"

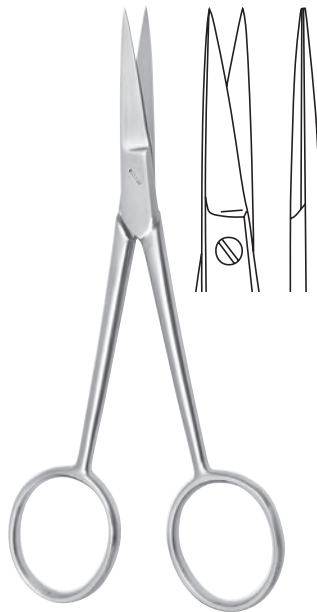

012-268-110 11,0 cm / 4 3/8"

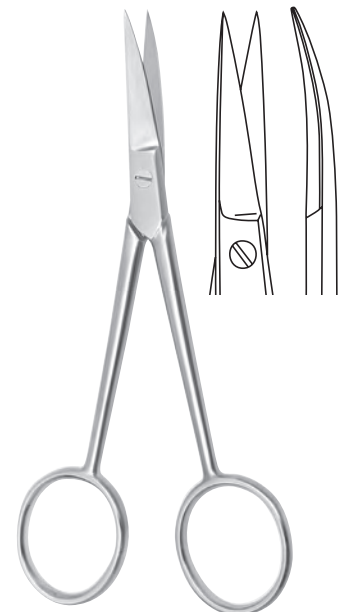

012-269-110 11,0 cm / 4 3/8"

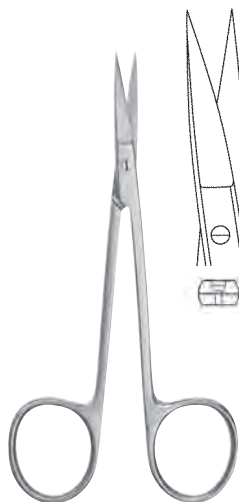

IRIS

012-270-090 9,0 cm / 3 1/2"
012-270-105 10,5 cm / 4 1/8"
012-270-115 11,5 cm / 4 1/2"

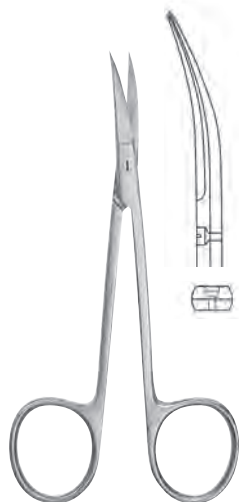

IRIS

012-271-090 9,0 cm / 3 1/2"
012-271-105 10,5 cm / 4 1/8"
012-271-115 11,5 cm / 4 1/2"



012-273-115 11,5 cm / 4 1/2"



012-275-115 11,5 cm / 4 1/2"

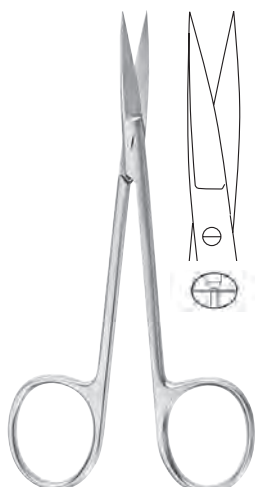

IRIS

012-276-090 9,0 cm / 3 1/2"
012-276-105 10,5 cm / 4 1/8"
012-276-115 11,5 cm / 4 1/2"



IRIS

012-277-090 9,0 cm / 3 1/2"
012-277-105 10,5 cm / 4 1/8"
012-277-115 11,5 cm / 4 1/2"



012

Feine chirurgische Scheren
Delicate Surgical Scissors
Tijeras finas para cirugía
Forbici fine per chirurgia



STEVENS
012-280-115 11,5 cm / 4 1/2"



STEVENS
012-281-115 11,5 cm / 4 1/2"



STEVENS
012-282-115 11,5 cm / 4 1/2"



STEVENS
012-283-115 11,5 cm / 4 1/2"



MOD. BONN
012-284-080 8,0 cm / 3 1/4"



MOD. BONN
012-285-080 8,0 cm, 3 1/4"

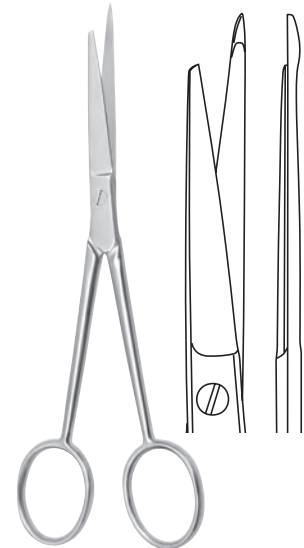

012-286-145 14,5 cm / 5 3/4"

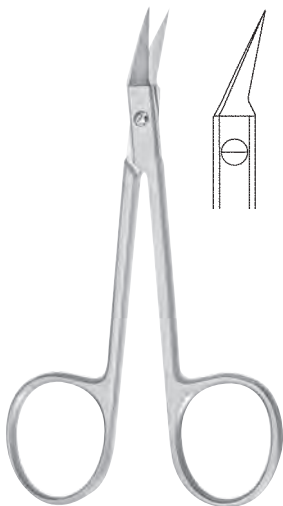

O'BRIAN
012-287-285 2,5 cm / 1 3/8"



STRABISMUS
012-288-115 11,5 cm / 4 1/2"



STRABISMUS
012-289-115 11,5 cm / 4 1/2"



WAGNER

012-290-120 12,0 cm / 4 3/4"



WAGNER

012-291-120 12,0 cm / 4 3/4"

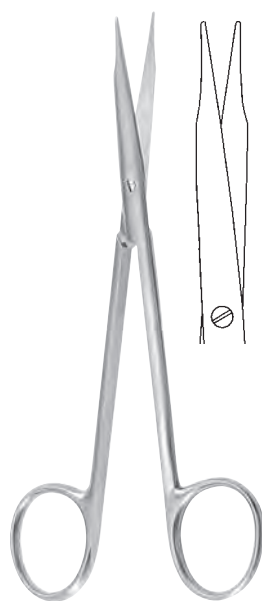

REYNOLDS

012-292-150 15,0 cm / 6"

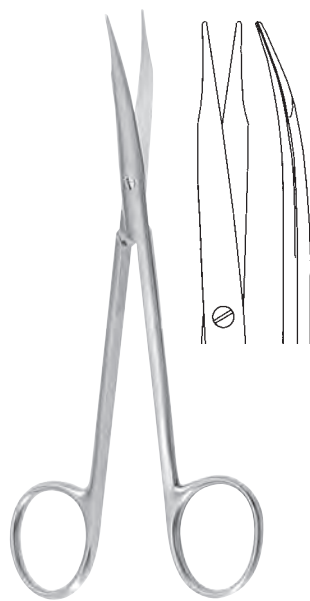

REYNOLDS

012-293-150 15,0 cm / 6"
012-293-175 17,5 cm / 6"

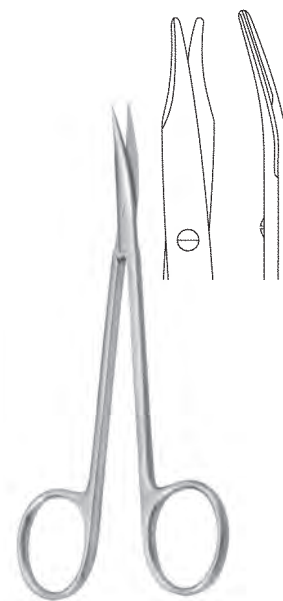

JAMESON

012-295-150 15,0 cm / 6"



012

Feine chirurgische Scheren, Gefäßscheren
Delicate Surgical Scissors, Vascular Scissors
Tijeras finas para cirugía, Tijeras vasculares
Forbici fine per chirurgia, Forbici vascolari

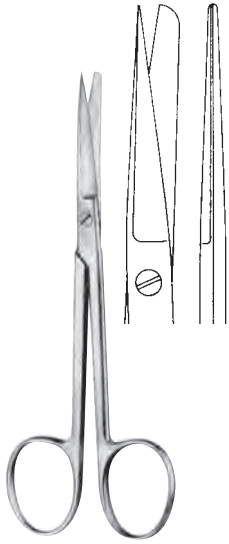

012-296-120 12,0 cm / 4³/₄"

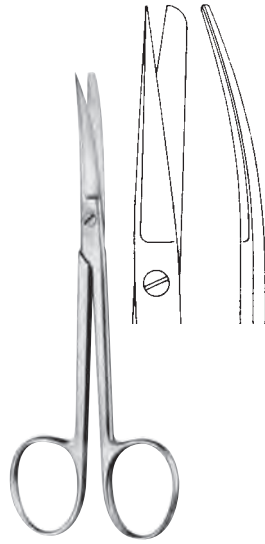

012-297-120 12,0 cm / 4³/₄"

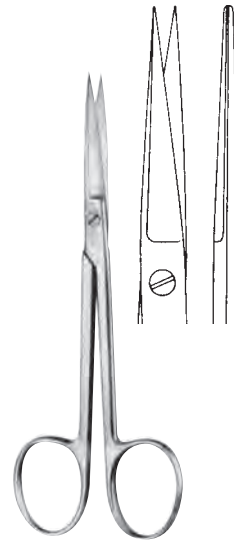

012-298-120 12,0 cm / 4³/₄"

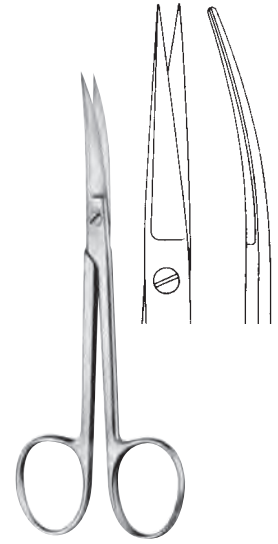

012-299-120 12,0 cm / 4³/₄"

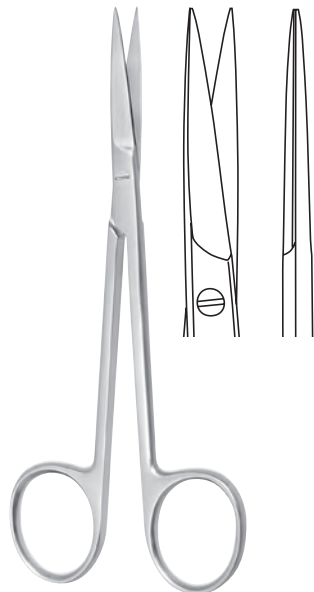

012-298-130 13,0 cm / 5¹/₈"

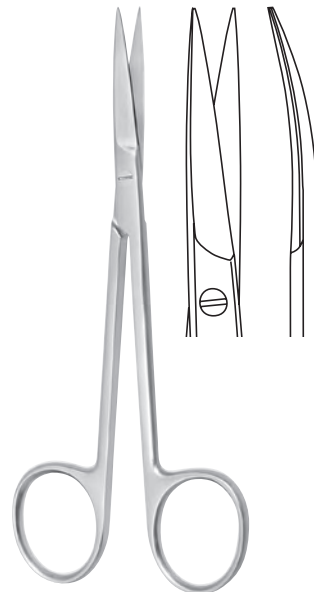

012-299-130 13,0 cm / 5¹/₈"

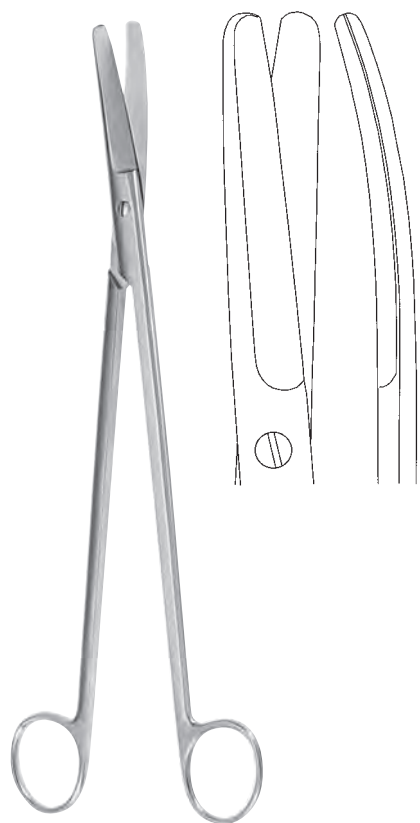

CRAFOORD

012-301-300 30,0 cm / 12"



SATINSKY

012-303-245 24,5 cm / 9³/₄"



KLINGENBERG-LOTH

012-305-230 23,0 cm / 9"

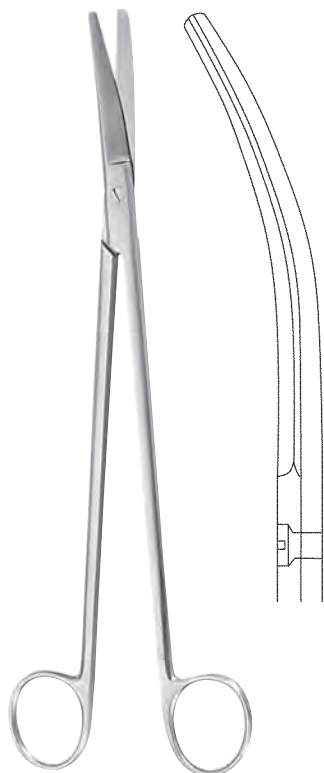

LLOYD-DAVIS

012-311-270 27,0 cm / 10⁵/₈"

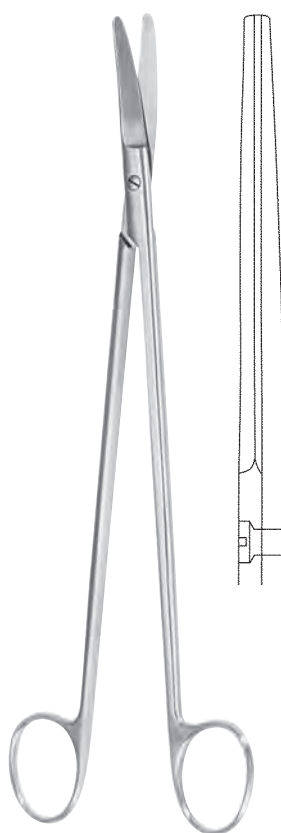

STELZNER

012-312-310 31,0 cm / 12¹/₄"

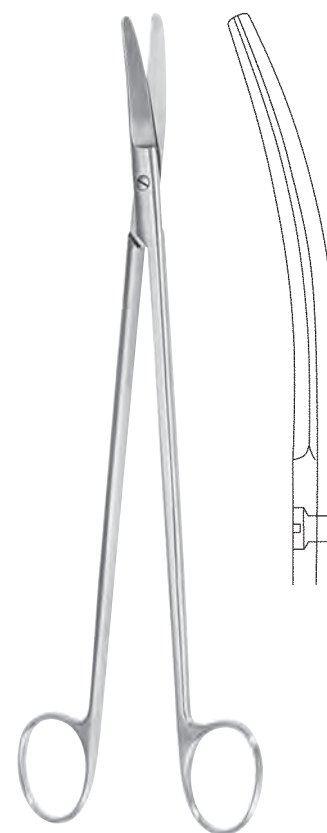

STELZNER

012-313-310 31,0 cm / 12¹/₄"



012

Lungenlappen- und Rektumscheren
Lobectomy and Rectal Scissors
Tijeras para lobectomía y recto
Forbici per lobo polmonare e per il retto

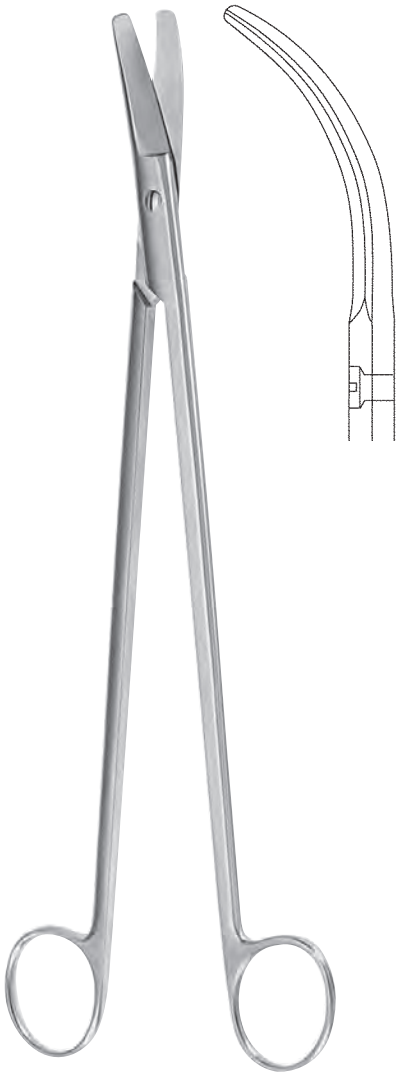

RECTAL

012-315-325 32,5 cm / 12³/₄"



FINOCHIETTO

012-317-270 27,0 cm / 10⁵/₈"

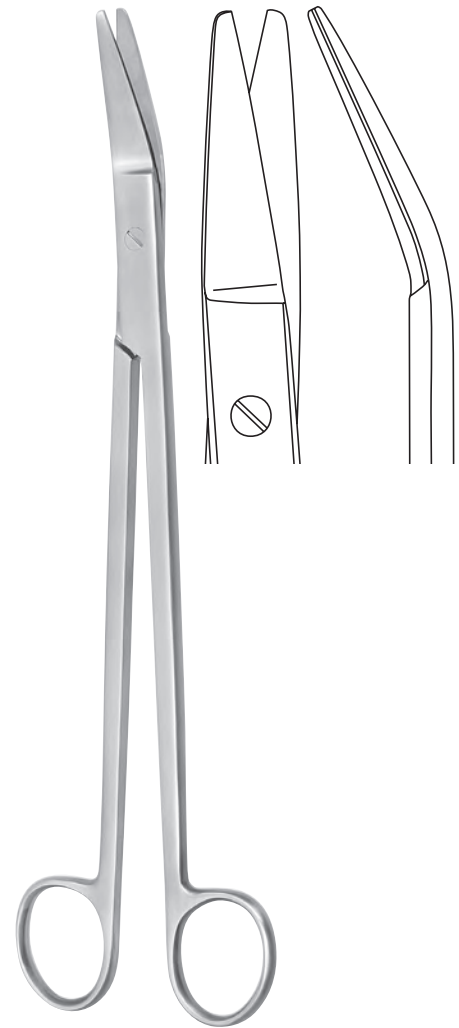

RESANO

012-319-250 25,0 cm / 9³/₄"

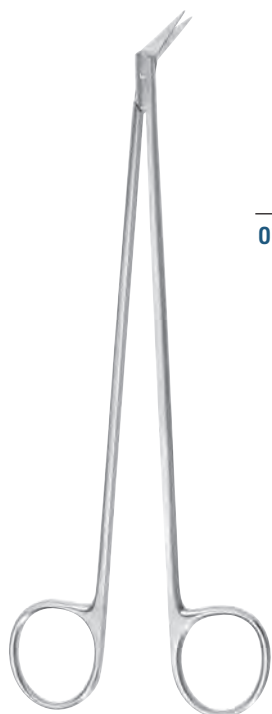

012-331-025



012-331-045



012-331-060

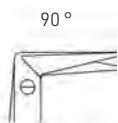

012-331-090



012-331-125

DIETRICH

012-331-025 - 012-331-125 19,0 cm / 7 1/2"



DIETRICH-HEGEMANN

012-333-125 19,0 cm / 7 1/2"

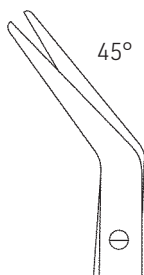
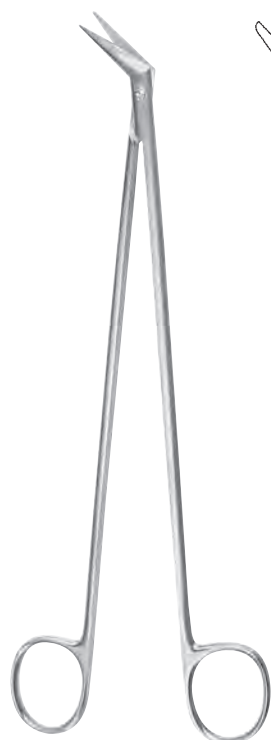

012-335-045

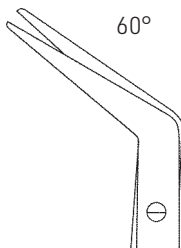

012-335-060

DE BAKEY

012-335-045 16,5 cm / 6 1/2"

012-335-060 16,0 cm / 6 1/4"



012

Gefäßscheren
Vascular Scissors
Tijeras vasculares
Forbici vascolari



012-337-025

012-337-045

012-337-060

POTTS-SMITH

012-337-025 - 012-337-060 19,0 cm / 7 1/2"

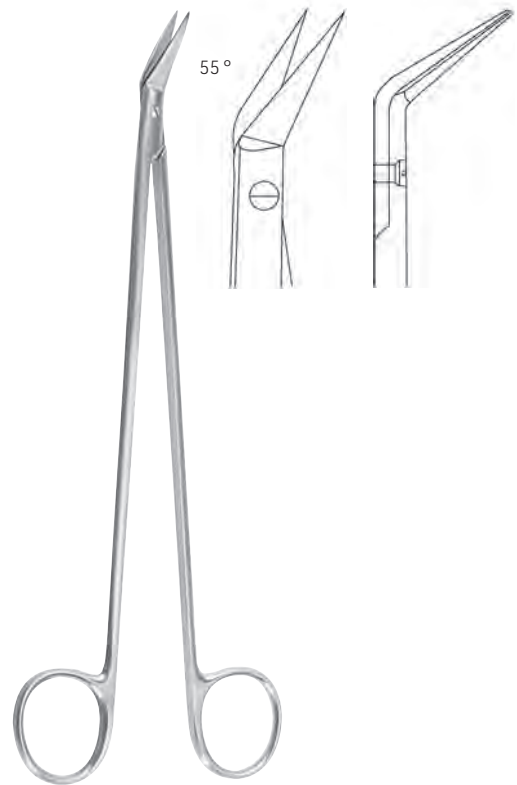

POTTS-SMITH

012-339-055 18,0 cm / 7"

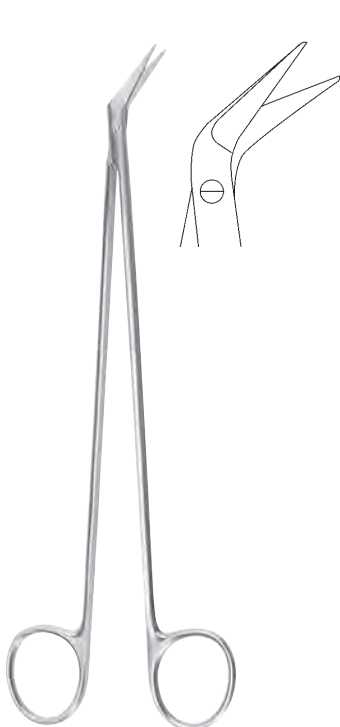

POTTS DE MARTEL

012-441-210 21,0 cm / 8 1/4"

012-441-240 24,0 cm / 9 1/2"



DE BAKEY

012-443-155 15,5 cm / 6"

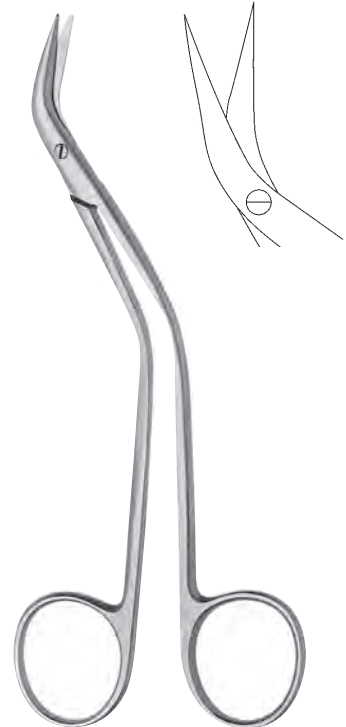

DE BAKEY

012-445-155 15,5 cm / 6"

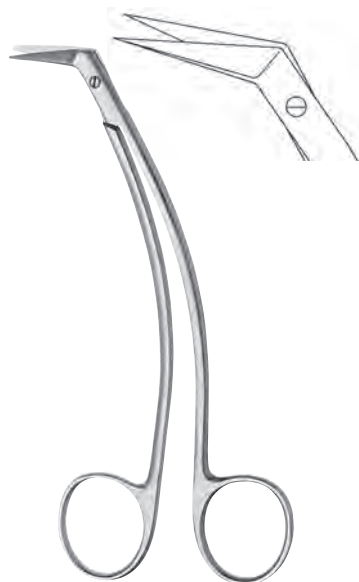

FAVALORO

012-447-155 15,5 cm / 6"

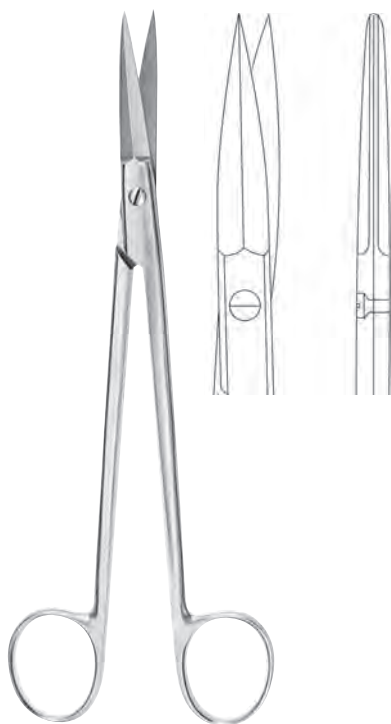

MC INDOE

012-448-190 19,0 cm / 7 1/2"



geklopftes Blatt
 probe-pointed blade
 punta botonada
 lame bottonuta

012-450-115 11,5 cm / 4 1/2"

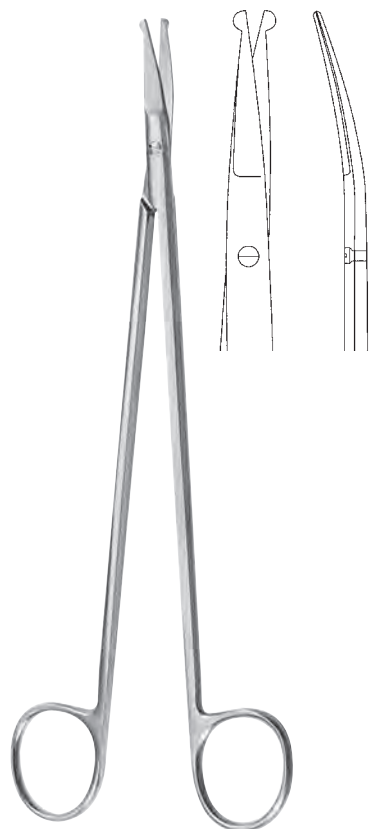

STRULLY

012-461-220 22,0 cm / 8 5/8"

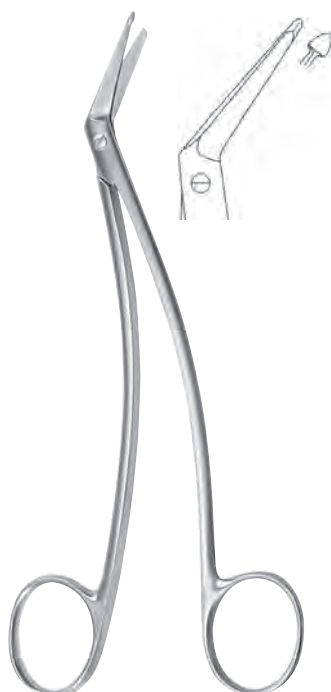

SCHMIEDEN-TAYLOR

012-463-170 17,0 cm / 6 3/4"

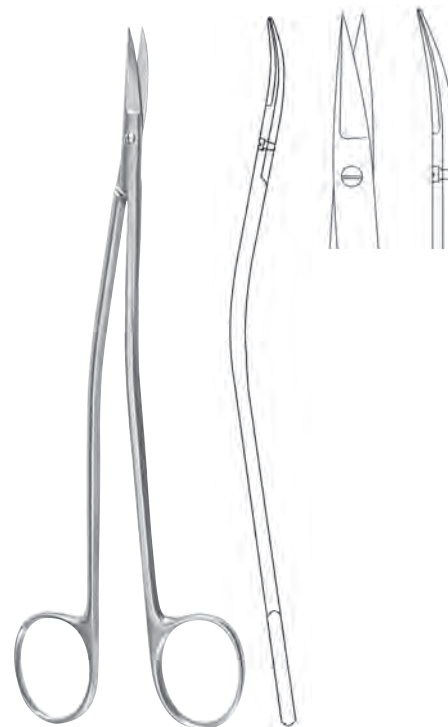

DANDY

012-465-170 17,0 cm / 6 3/4"



012

Gefäßscheren
Vascular Scissors
Tijeras vasculares
Forbici vascolari



012-466-180

012-467-180

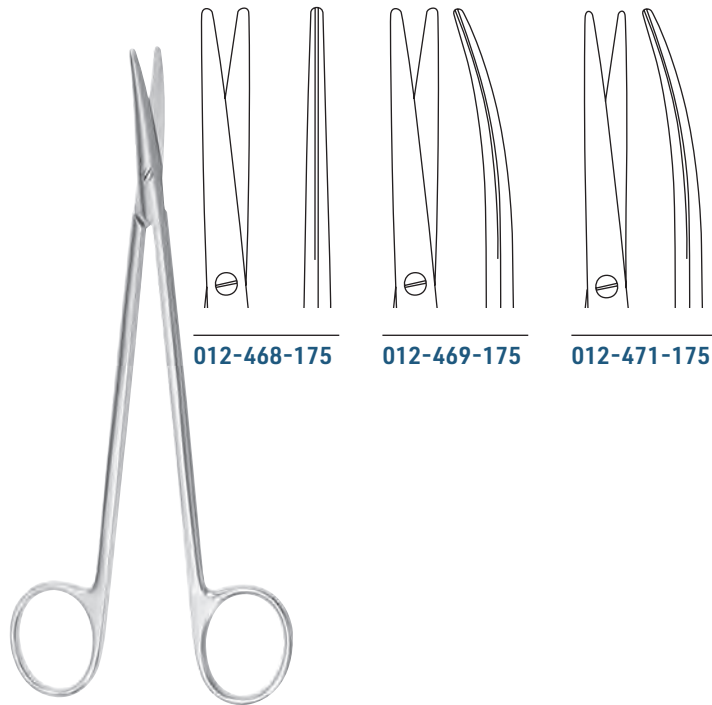

012-468-175

012-469-175

012-471-175

TOENNIS

012-466-180 - 012-467-180 18,0 cm / 7"

TOENNIS-ADSON

012-468-175 - 012-471-175 17,5 cm / 7"



OLIVECRONA

012-473-230 23,0 cm / 9"

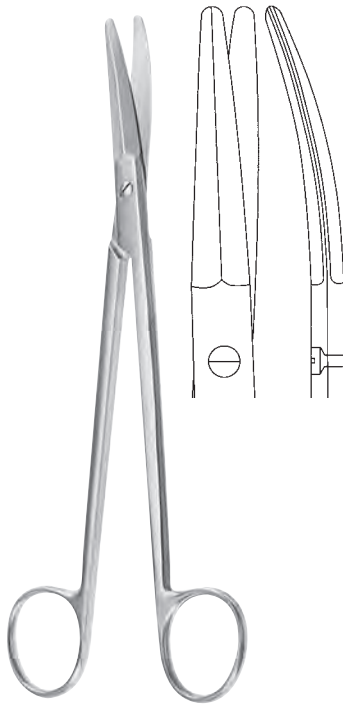

BOETTCHER

012-501-180 18,0 cm / 7"

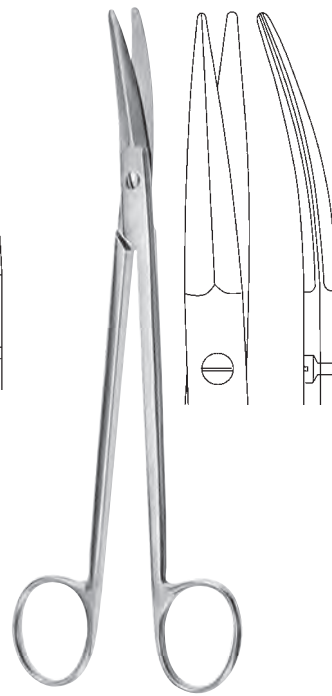

PRINCE

012-503-175 17,5 cm / 7"

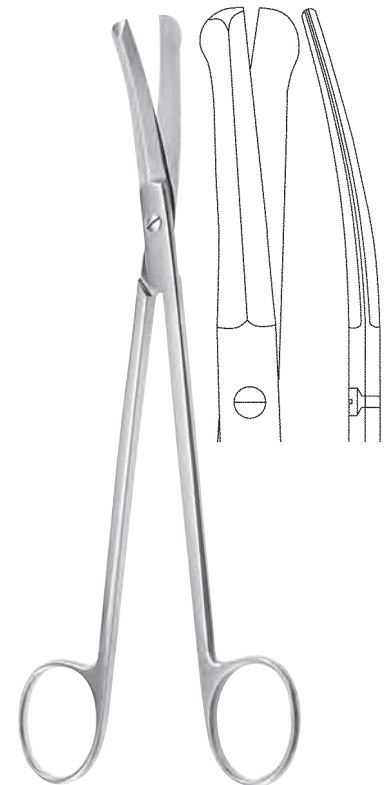

GOOD

012-505-190 19,0 cm / 7 1/2"



HEYMANN

012-507-180 18,0 cm / 7"

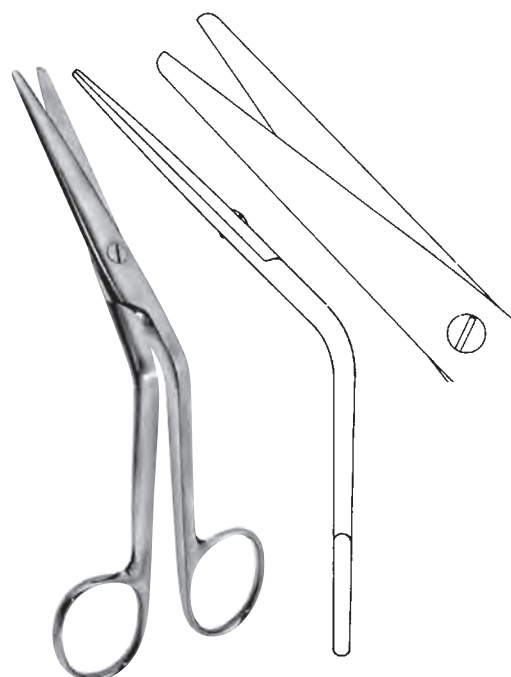

COTTLE

012-509-160 16,0 cm / 6 1/4"



FOMON

012-511-150 15,0 cm / 6"



KIRSTEIN

012-513-180 18,0 cm / 7"



012

Zahnfleischscheren
Gum Scissors
Tijeras para encías
Forbici per gengiva



012-550-160

012-551-160

KELLY

012-550-160 - 012-551-160 16,0 cm / 6¹/₄"

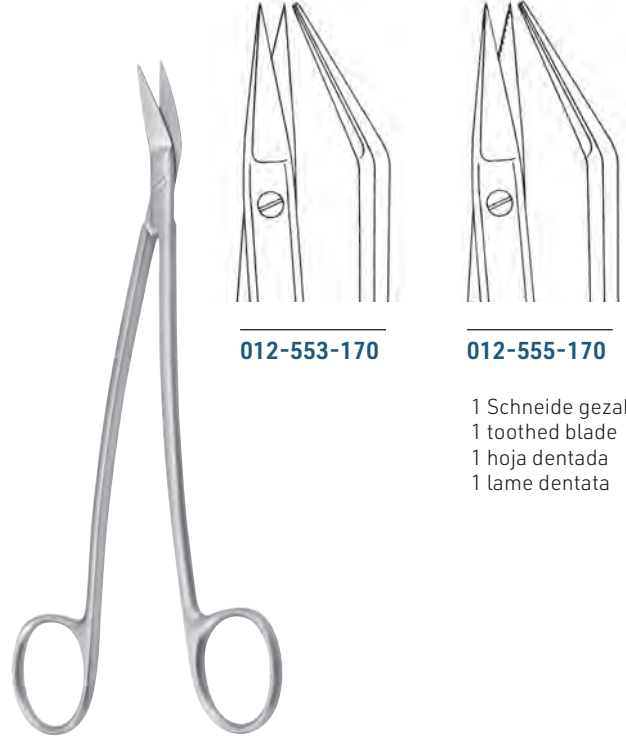

012-553-170

012-555-170

DEAN

012-553-170 - 012-555-170 17,0 cm / 6³/₄"

1 Schneide gezahnt
1 toothed blade
1 hoja dentada
1 lame dentata

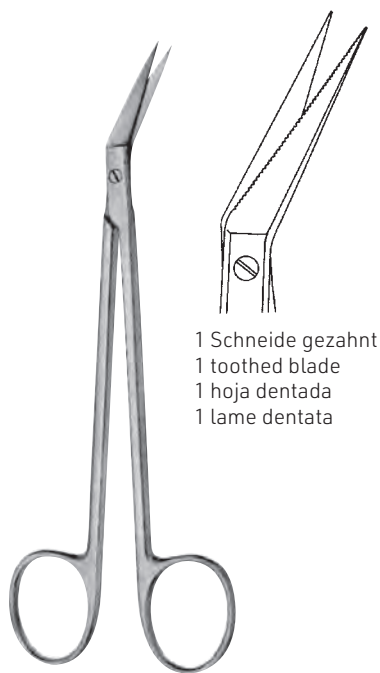

1 Schneide gezahnt
1 toothed blade
1 hoja dentada
1 lame dentata

LOCKLIN

012-557-160 16,0 cm / 6¹/₄"

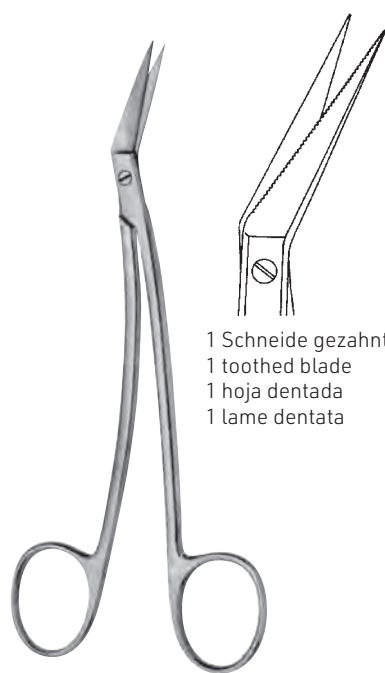

1 Schneide gezahnt
1 toothed blade
1 hoja dentada
1 lame dentata

LOCKLIN

012-559-160 16,0 cm / 6¹/₄"



QUINBY

012-561-125 12,5 cm / 5"

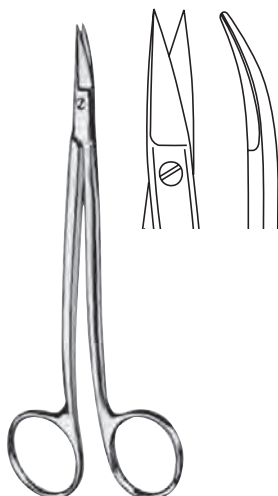

NEUMANN

012-563-125 12,5 cm / 5"

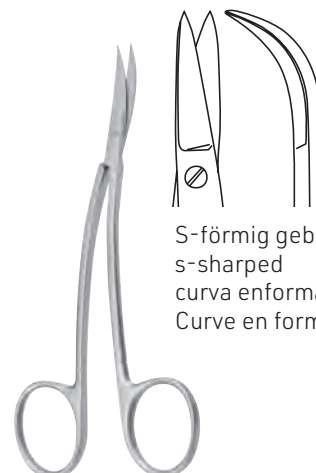

S-förmig gebogen
 s-sharped
 curva en forma S
 Curve en forma S

LA GRANGE

012-565-115 11,5 cm / 4 1/2"



012-566-130



012-567-130

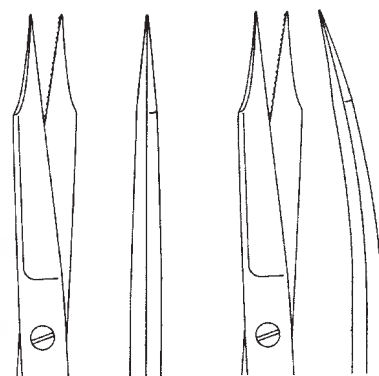

012-568-130

012-569-130

1 Schneide gezahnt
 1 toothed blade
 1 hoja dentada
 1 lame dentata



GOLDMANN-FOX

012-568-130 - 012-569-130 13,0 cm / 5 1/8"

GOLDMANN-FOX

012-566-130 - 012-567-130 13,0 cm / 5 1/8"



012

Drahtscheren
Wire Cutting Scissors
Cizallas corta-alambres
Forbici taglia cavo



012-570-105

012-571-105

BEEBEE

012-570-105 - 012-571-105

10,5 cm / 4¹/₄"



012-572-105

012-573-105

BEEBEE

012-572-105 - 012-573-105

10,5 cm / 4¹/₄"

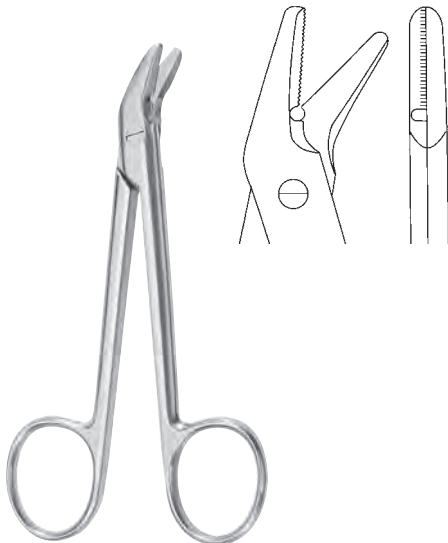

UNIVERSAL

012-575-120 12,0 cm / 4³/₄"



012-580-210 21,0 cm / 8¹/₄"



012-582-210 21,0 cm / 8¹/₄"



012-584-210 21,0 cm / 8¹/₄"



012

Ligaturscheren
Ligature Scissors
Tijeras para ligaduras
Forbici per legature



SPENCER

- 012-590-090** 9,0 cm / 3 1/2"
- 012-590-105** 11,0 cm / 4 1/4"
- 012-590-130** 13,0 cm / 5 1/8"



NORTHBENT

- 012-591-090** 9,0 cm / 3 1/2"
- 012-591-125** 12,5 cm / 5"



LITTAUER

- 012-592-140** 14,0 cm / 5 1/2"



BUCK

- 012-594-145** 14,5 cm / 5 3/4"
- 012-594-180** 18,0 cm / 7"

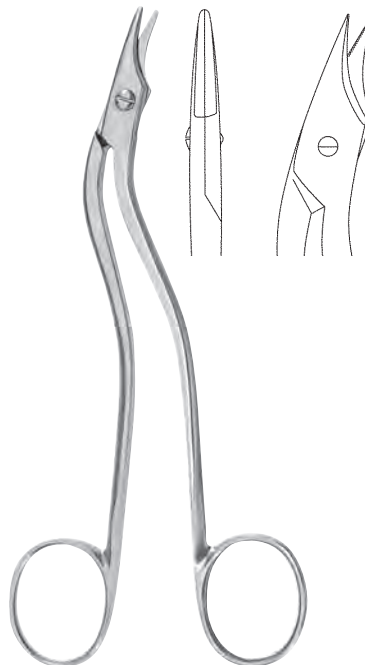

HEATH

- 012-595-160** 16,0 cm / 6 1/4"



EISELSBERG

- 012-596-120** 12,0 cm / 4 3/4"

- lange Lebensdauer
- hohe Wirtschaftlichkeit
- hervorragende Schnitthaltigkeit
- glatter weicher Schnitt
- durchgehend gehärtet
- vergoldete Ringe zur schnellen Identifikation

-
- long lasting performance
 - economical
 - excellent cutting action
 - smooth cutting
 - fully tempered
 - goldplated rings for easy identification

-
- larga duración
 - gran economía
 - corte de máxima agudeza
 - suave filo
 - completamente templado
 - anillos dorados para su identificación

-
- prestazioni die lunga durata
 - risparmi sul costo
 - eccellente accuratezza del taglio
 - taglio liscio
 - completamente temperato
 - anelli bagnati in oro permettono una piú semplice identificazione





012

Chirurgische Scheren mit Hartmetallschneiden
Surgical Scissors with tungsten carbide edges
Tijeras para cirugía con filos de carburo tungsteno
Forbici per chirurgia con lame in carburo di tungsteno



STANDARD
012-700-145 14,5 cm / 5³/₄"



STANDARD
012-701-145 14,5 cm / 5³/₄"



STANDARD
012-702-145 14,5 cm / 5³/₄"



STANDARD
012-703-145 14,5 cm / 5³/₄"

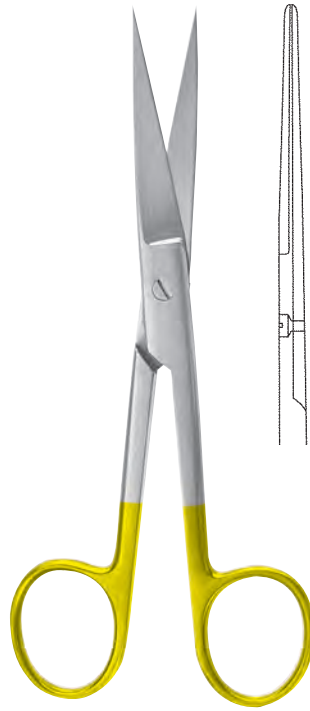

STANDARD
012-704-145 14,5 cm / 5³/₄"



STANDARD
012-705-145 14,5 cm / 5³/₄"

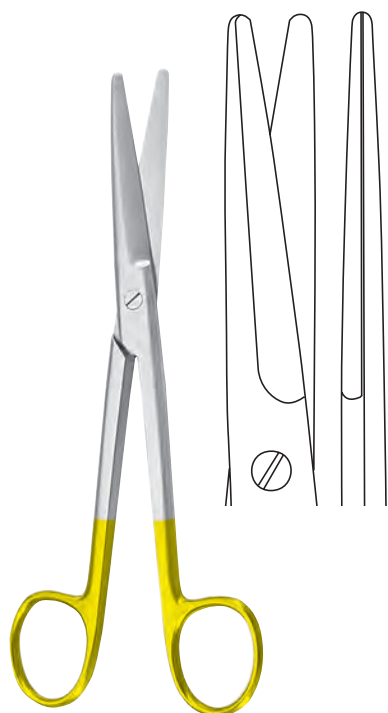

MAYO

- 012-710-145** 14,5 cm / 5³/₄"
- 012-710-170** 17,0 cm / 6³/₄"
- 012-710-230** 23,0 cm / 9"

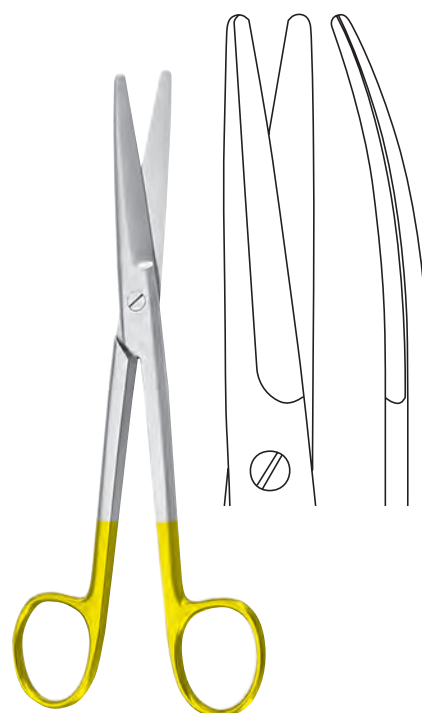

MAYO

- 012-711-145** 14,5 cm / 5³/₄"
- 012-711-170** 17,0 cm / 6³/₄"
- 012-711-230** 23,0 cm / 9"



MAYO-STILLE

- 012-714-150** 15,0 cm / 6"
- 012-714-170** 17,0 cm / 6³/₄"

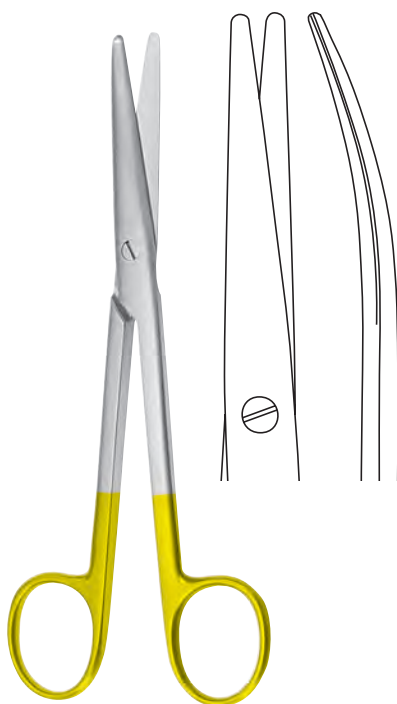

MAYO-STILLE

- 012-715-150** 15,0 cm / 6"
- 012-715-170** 17,0 cm / 6³/₄"



MAYO-LEXER

- 012-720-160 - 012-721-160** 16,0 cm / 6¹/₄"

012-720-160

012-721-160



012

Chirurgische Scheren mit Hartmetallschneiden
 Surgical Scissors with tungsten carbide edges
 Tijeras para cirugía con filos de carburo tungsteno
 Forbici per chirurgia con lame in carburo di tungsteno



LEXER

012-722-160 16,0 cm / 6 1/4"
012-722-210 21,0 cm / 8 1/4"



LEXER

012-723-160 16,0 cm / 6 1/4"
012-723-210 21,0 cm / 8 1/4"



012-730-115

012-731-115

METZENBAUM

012-730-115 - 012-731-115 11,5 cm / 4 1/2"



012-730-145

012-731-145

METZENBAUM

012-730-145 - 012-731-145 14,5 cm / 5 1/2"

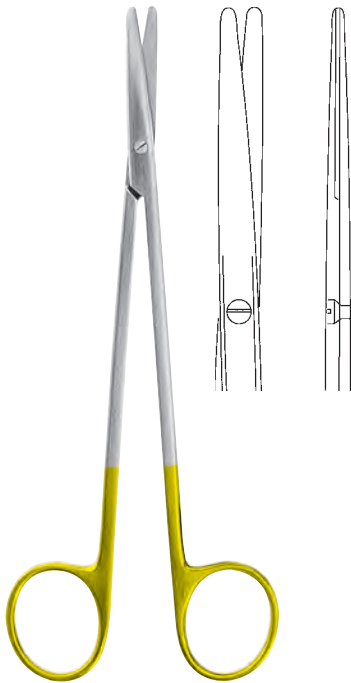

METZENBAUM

012-730-180	18,0 cm / 7"
012-730-200	20,0 cm / 8"
012-730-230	23,0 cm / 9"
012-730-250	25,0 cm / 10"
012-730-280	28,0 cm / 11"
012-730-300	30,0 cm / 12"

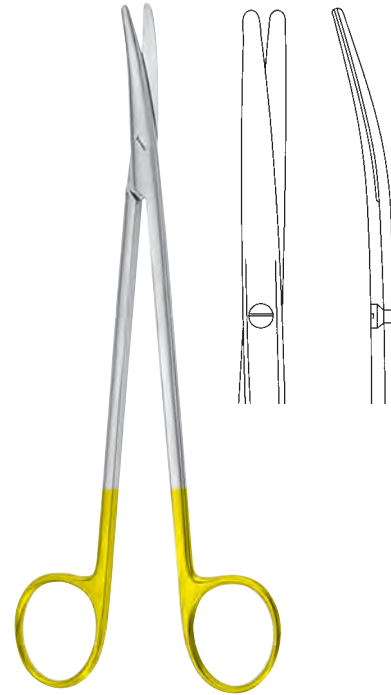

METZENBAUM

012-731-180	18,0 cm / 7"
012-731-200	20,0 cm / 8"
012-731-230	23,0 cm / 9"
012-731-250	25,0 cm / 10"
012-731-280	28,0 cm / 11"
012-731-300	30,0 cm / 12"



012-740-145

012-741-145

METZENBAUM-FINO

012-740-145 - 012-741-145	14,5 cm / 5 1/2"
----------------------------------	------------------



012-742-145

012-743-145

METZENBAUM-FINO

012-742-145 - 012-743-145	14,5 cm / 5 1/2"
----------------------------------	------------------



012

Präparierscheren mit Hartmetallschneiden
Dissecting Scissors with tungsten carbide edges
Tijeras para disección con filos de carburo tungsteno
Forbici per dissezione con lame in carburo di tungsteno

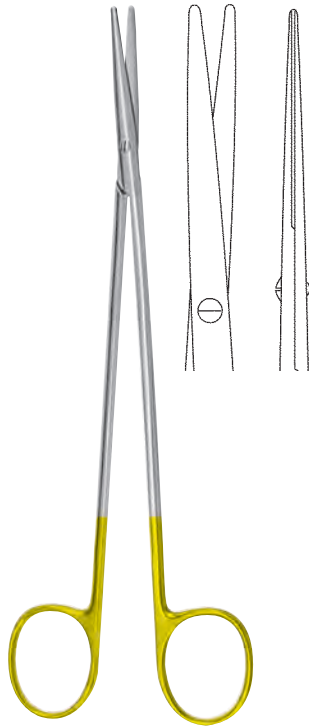

METZENBAUM-FINO

012-740-180	18,0 cm / 7"
012-740-200	20,0 cm / 8"
012-740-230	23,0 cm / 9"
012-740-250	25,0 cm / 10"
012-740-280	28,0 cm / 11"

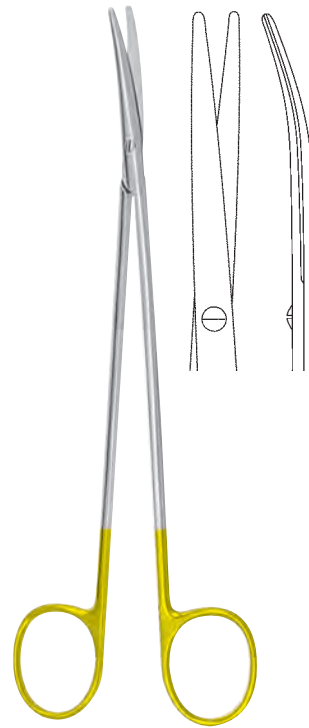

METZENBAUM-FINO

012-741-180	18,0 cm / 7"
012-741-200	20,0 cm / 8"
012-741-230	23,0 cm / 9"
012-741-250	25,0 cm / 10"
012-741-280	28,0 cm / 11"

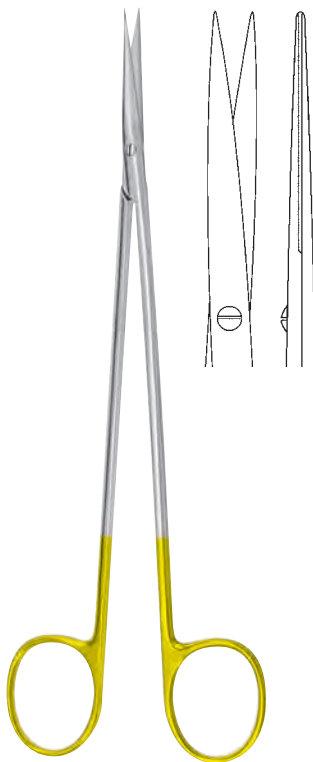

METZENBAUM-FINO

012-742-180	18,0 cm / 7"
012-742-200	20,0 cm / 8"
012-742-230	23,0 cm / 9"

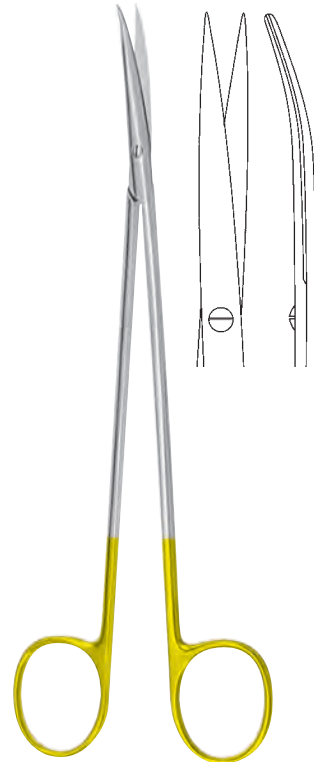

METZENBAUM-FINO

012-743-180	18,0 cm / 7"
012-743-200	20,0 cm / 8"
012-743-230	23,0 cm / 9"

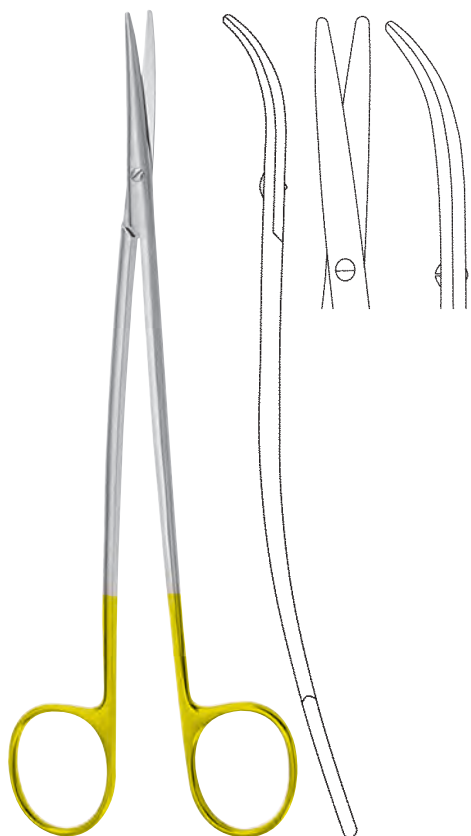

METZENBAUM-FINO S

012-745-180	18,0 cm / 7"
012-745-200	20,0 cm / 8"
012-745-230	23,0 cm / 9"

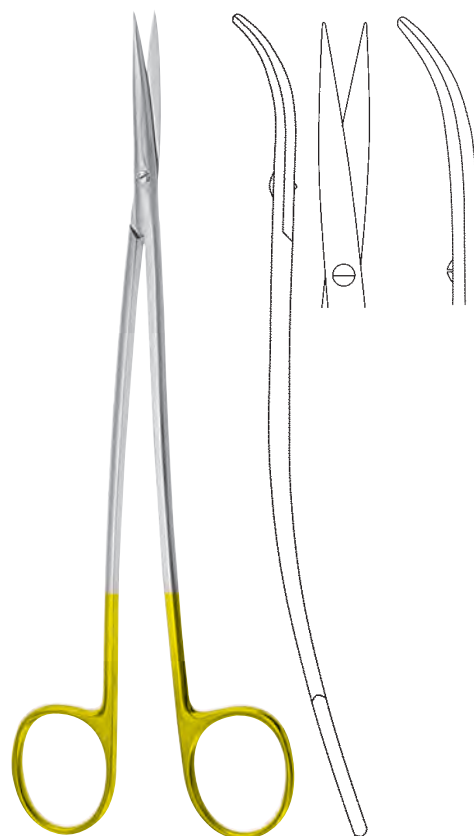

METZENBAUM-FINO S

012-747-180	18,0 cm / 7"
012-747-200	20,0 cm / 8"
012-747-230	23,0 cm / 9"

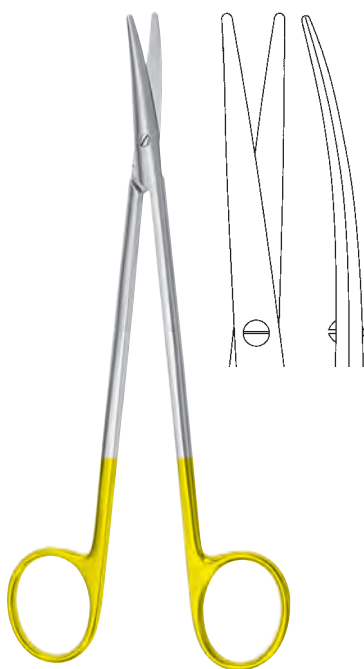

TOENNIS-ADSON

012-749-175	17,5 cm / 7"
--------------------	--------------



012

Gefäßscheren mit Hartmetallschneiden
Vascular Scissors with tungsten carbide edges
Tijeras vasculares con filos de carburo tungsteno
Forbici vascolari con lame in carburo di tungsteno



25°

012-761-025

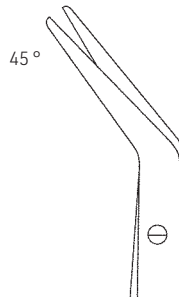

45°

012-761-045

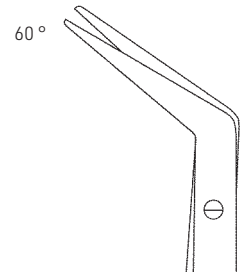

60°

012-761-060

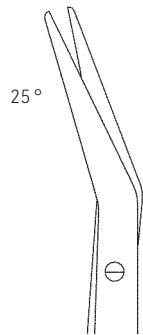

25°

012-763-025

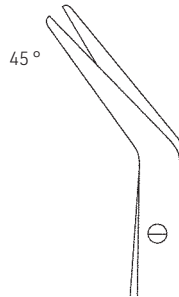

45°

012-763-045

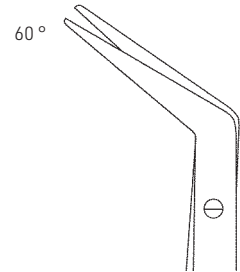

60°

012-763-060

DE BAKEY

012-761-025 - 012-761-060 18,0 cm / 7"
012-763-025 - 012-763-060 23,0 cm / 9"

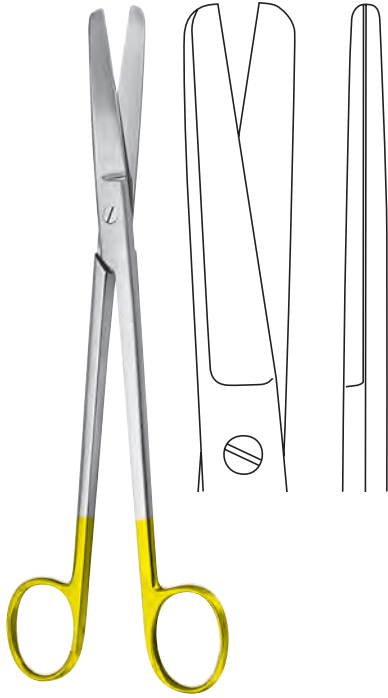

SIMS

012-770-200 20,0 cm / 8"
012-770-230 23,0 cm / 9"

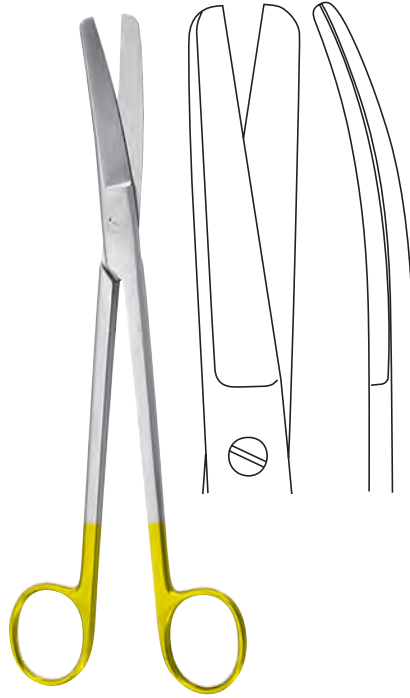

SIMS

012-771-200 20,0 cm / 8"
012-771-230 23,0 cm / 9"

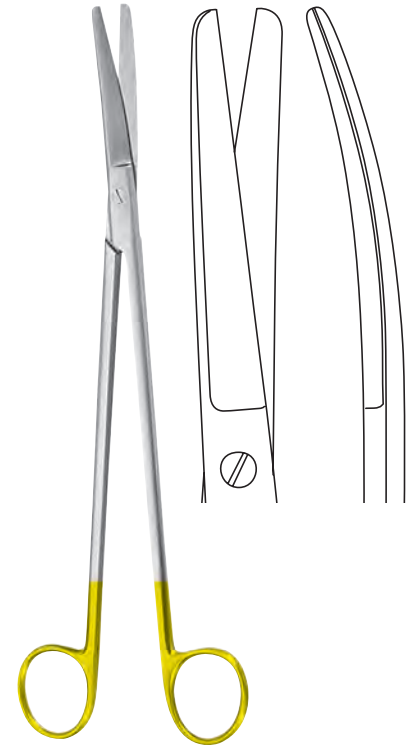

WERTHEIM

012-773-225 22,5 cm / 8³/₄"

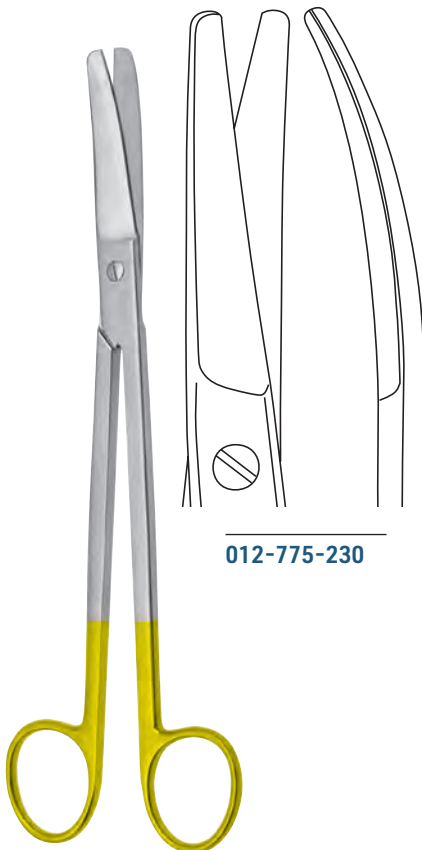

012-775-230



012-775-225

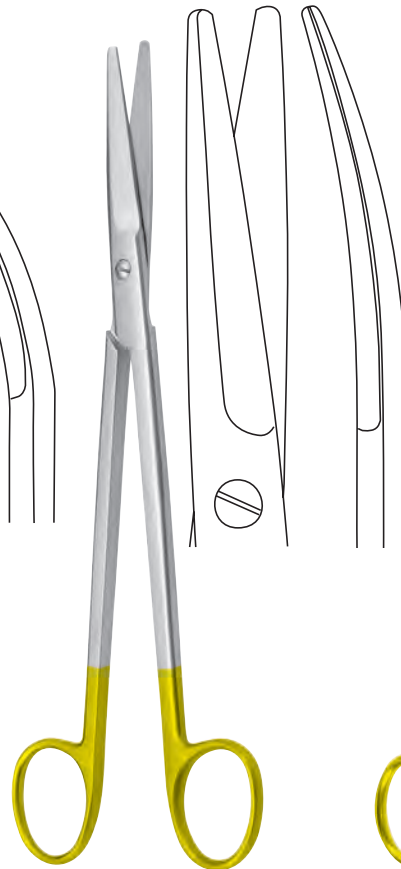

MAYO-HARRINGTON

012-777-280 28,0 cm / 11"



gezahnt
toothed
dentada
dentate

PARAMETRIUM

012-775-225 22,5 cm / 8³/₄"
012-775-230 23,0 cm / 9"

012-778-195 19,5 cm / 7³/₄"



012

Scheren mit Hartmetallschneiden
 Scissors with tungsten carbide edges
 Tijeras con filos de carburo tungsteno
 Forbici con lame in carburo di tungsteno



IRIS
012-780-115 11,5 cm / 4 1/2"



IRIS
012-781-115 11,5 cm / 4 1/2"

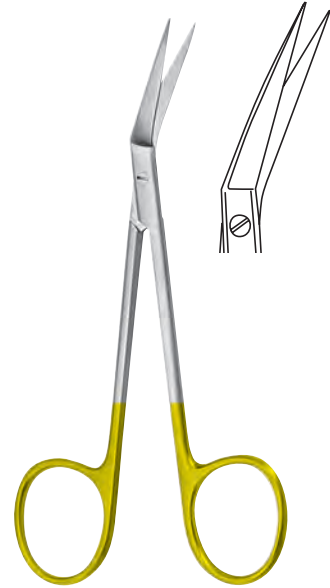

IRIS
012-783-115 11,5 cm / 4 1/2"



JOSEPH
012-784-140 - 012-785-140 14,0 cm, 5 1/2"

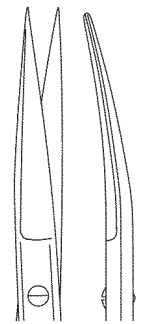

012-785-140



012-786-160



012-787-160



KELLY
012-786-160 - 012-787-160 16,0 cm / 6 1/4"

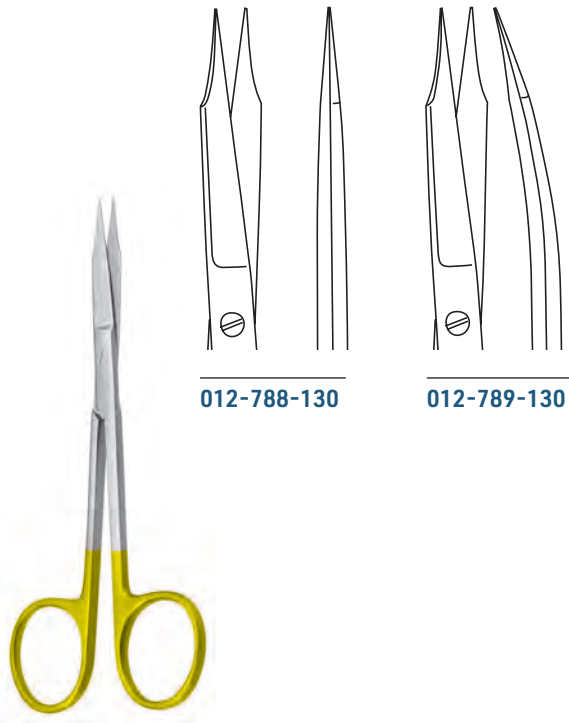

012-788-130

012-789-130

GOLDMANN-FOX

012-788-130 - 012-789-130 13,0 cm / 5 1/8"

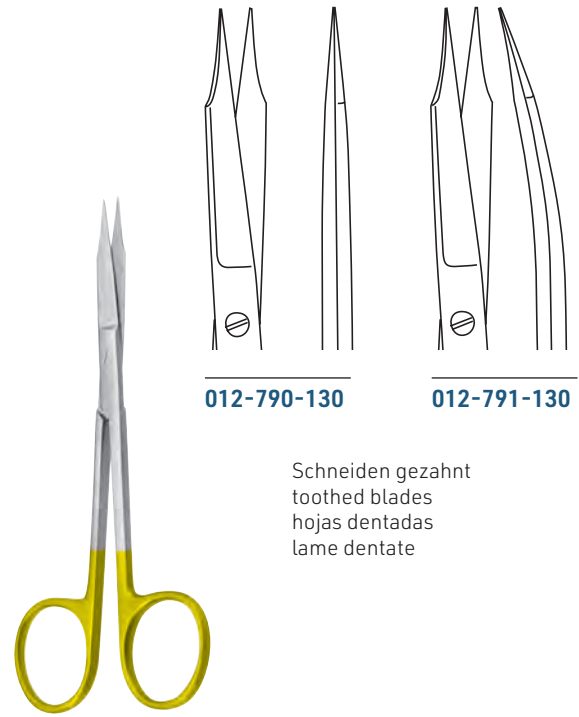

012-790-130

012-791-130

Schneiden gezahnt
 toothed blades
 hojas dentadas
 lame dentate

GOLDMANN-FOX

012-790-130 - 012-791-130 13,0 cm / 5 1/8"



1 Schneide gezahnt
 1 toothed blade
 1 hoja dentada
 1 lame dentate

LOCKLIN

012-793-160 16,0 cm / 6 1/4"

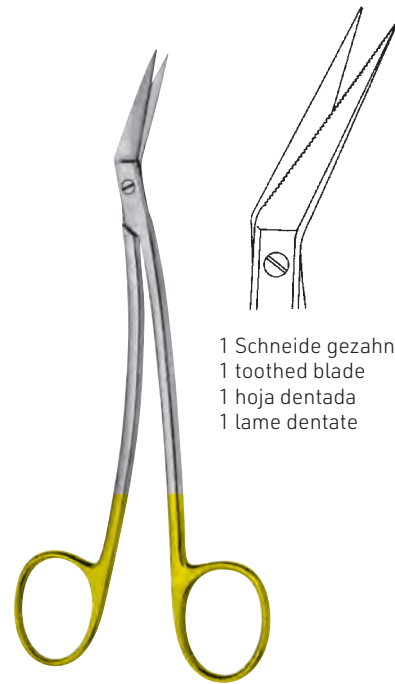

1 Schneide gezahnt
 1 toothed blade
 1 hoja dentada
 1 lame dentate

LOCKLIN

012-795-160 16,0 cm / 6 1/4"



012

Scheren mit Hartmetallschneiden
Scissors with tungsten carbide edges
Tijeras con filos de carburo tungsteno
Forbici con lame in carburo di tungsteno



RAGNELL (KILLNER)

012-797-120 12,0 cm / 4³/₄"

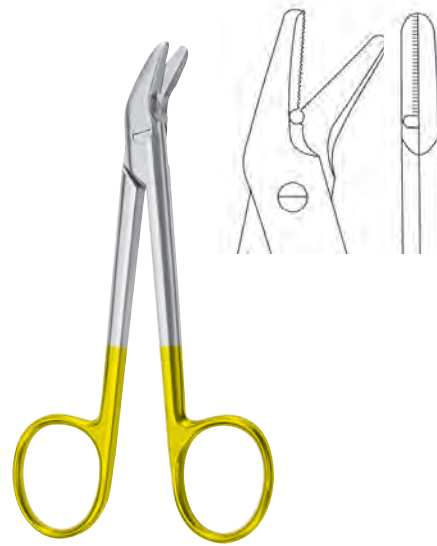

UNIVERSAL

012-799-120 12,0 cm / 4³/₄"

Super Cut

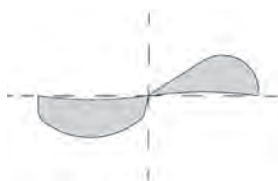

Standard

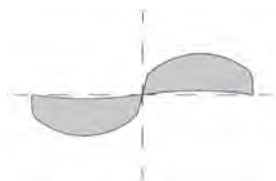

- Messerschliff für optimalen Schnitt
- 1 gezahntes Blatt verhindert das Herausgleiten des Gewebes
- schwarze Ringe

-
- Knife blade sharpness for optimum cutting
 - 1 serrated blade prevents tissue from slipping out
 - black-plated rings

-
- Filo tipo cuchillo para un corte óptimo
 - 1 hoja dentada impide el deslizamiento del tejido
 - anillos negros

-
- affilatura speciale per un ottimo taglio
 - Lama a denti micro
 - anelli neri





012

Super-Cut Scheren
Super-Cut Scissors
Tijeras Super-Cut
Forbici Super-Cut



STANDARD

012-850-145 14,5 cm / 5³/₄"



STANDARD

012-851-145 14,5 cm / 5³/₄"

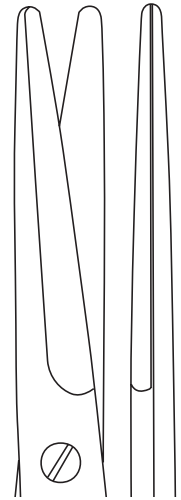
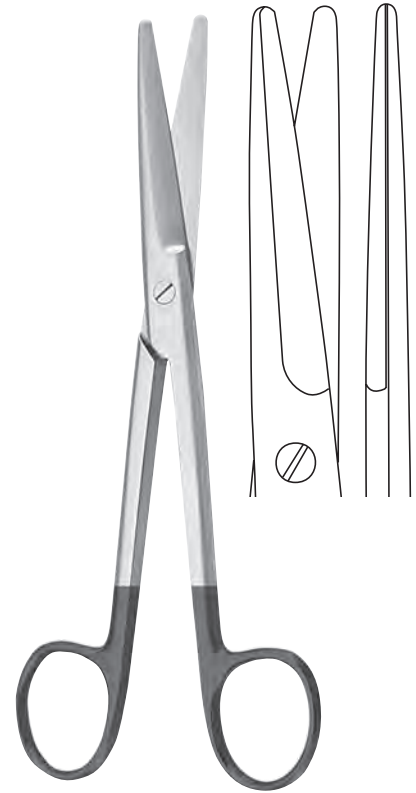

MAYO

012-852-145 14,5 cm / 5³/₄"

012-852-170 17,0 cm / 6³/₄"

012-852-230 23,0 cm / 9"

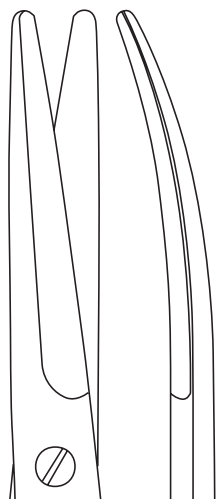
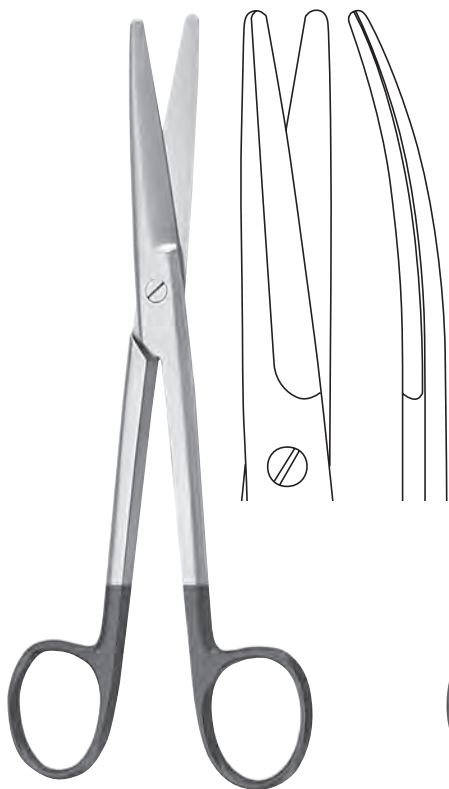

MAYO

012-853-145 14,5 cm / 5³/₄"

012-853-170 17,0 cm / 6³/₄"

012-853-230 23,0 cm / 9"

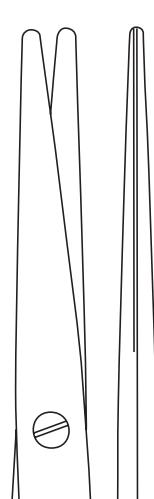
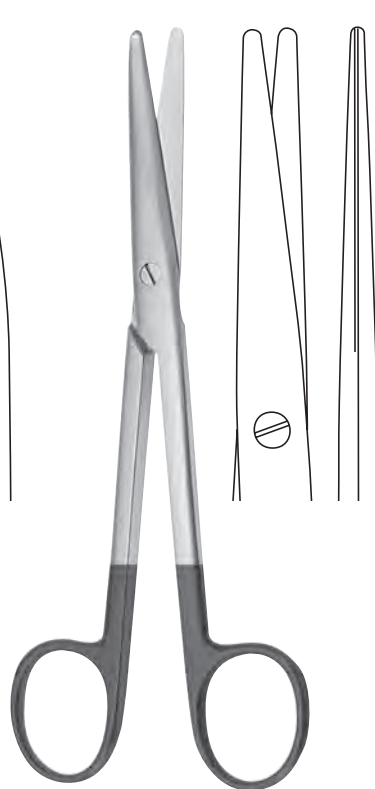

MAYO-STILLE

012-854-150 15,0 cm / 6"

012-854-170 17,0 cm / 6³/₄"

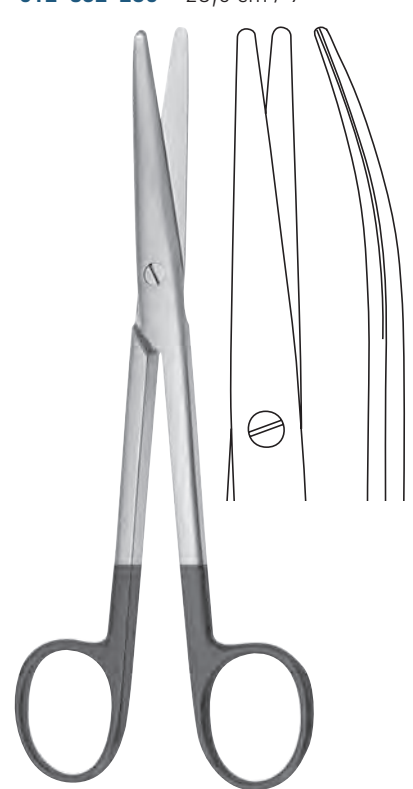

MAYO-STILLE

012-855-150 15,0 cm / 6"

012-855-170 17,0 cm / 6³/₄"



012-860-115

012-861-115

METZENBAUM

012-860-115 - 012-861-115 11,5 cm / 4 1/2"



012-860-145

012-861-145

METZENBAUM

012-860-145 - 012-861-145 14,5 cm / 5 1/2"



METZENBAUM-NELSON

012-860-180 18,0 cm / 7"

012-860-200 20,0 cm / 8"

012-860-230 23,0 cm / 9"



METZENBAUM-NELSON

012-861-180 18,0 cm / 7"

012-861-200 20,0 cm / 8"

012-861-230 23,0 cm / 9"



012

Super-Cut Scheren
Super-Cut Scissors
Tijeras Super-Cut
Forbici Super-Cut



012-864-115

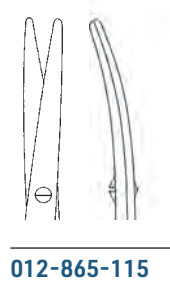

012-865-115

STRABISMUS

012-864-115 - 012-865-115 11,5 cm / 4 1/2"



012-866-160

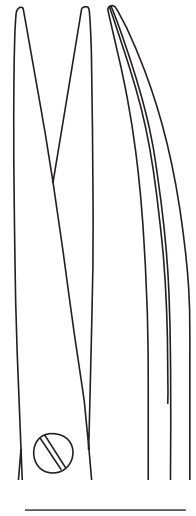

012-867-160

LEXER

012-866-160 - 012-867-160 16,0 cm / 6 1/4"



012-870-145

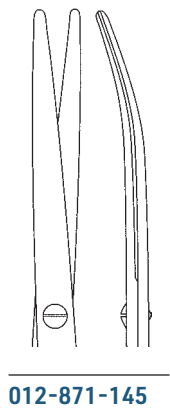

012-871-145

METZENBAUM-FINO

012-870-145 - 012-871-145 14,5 cm / 5 1/2"

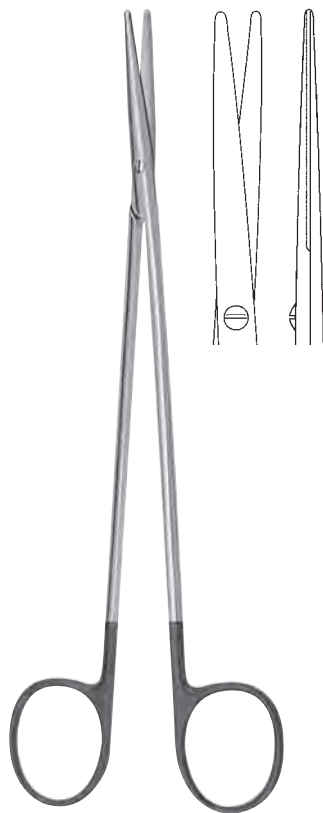

METZENBAUM-FINO

012-870-180 18,0 cm / 7"
012-870-200 20,0 cm / 8"
012-870-230 23,0 cm / 9"

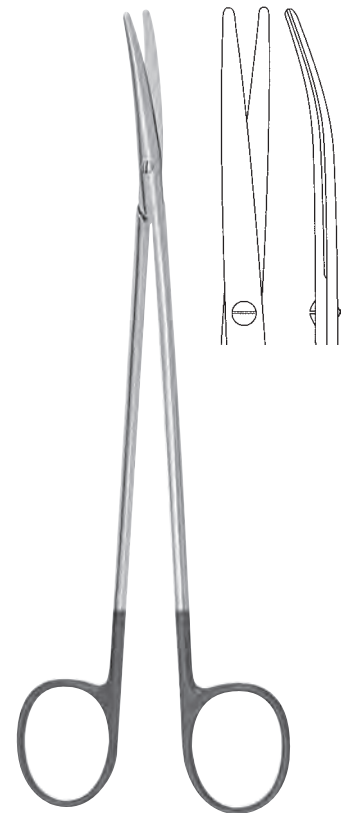

METZENBAUM-FINO

012-871-180 18,0 cm / 7"
012-871-200 20,0 cm / 8"
012-871-230 23,0 cm / 9"



TOENNIS-ADSON

012-873-175 17,5 cm / 7"

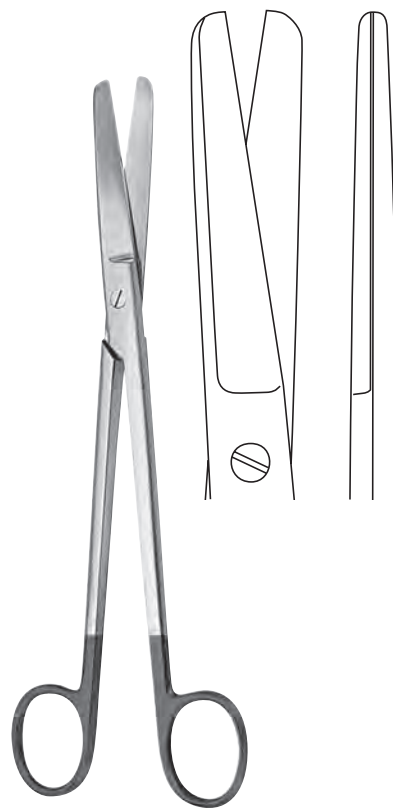

SIMS

012-880-200 20,0 cm / 8"

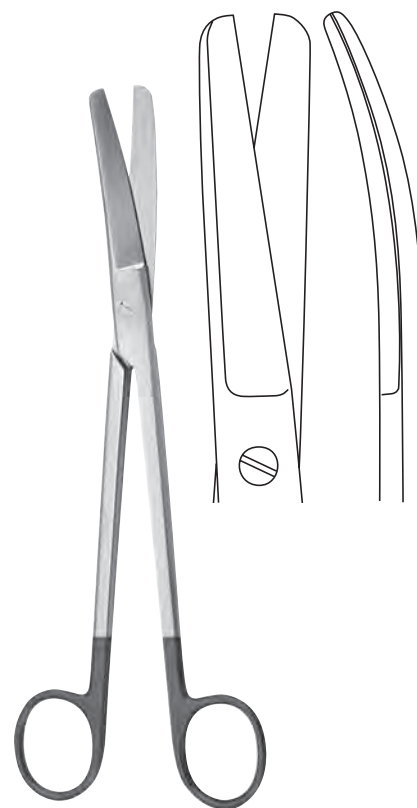

SIMS

012-881-200 20,0 cm / 8"
012-881-230 23,0 cm / 9"



SIEBOLD

012-883-240 24,0 cm / 9 1/2"



WALDMANN

012-885-180 18,0 cm / 7"



012-887-200 20,0 cm / 8"

Episiotomiescheren
 Episiotomy scissors
 Tijeras para episiotomía
 Forbici per episiotomia



012

Super-Cut Scheren
Super-Cut Scissors
Tijeras Super-Cut
Forbici Super-Cut

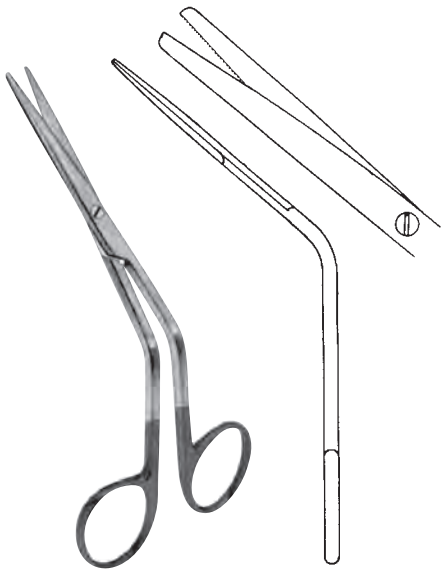

FOMON
012-891-135 13,5 cm, 5 1/4"

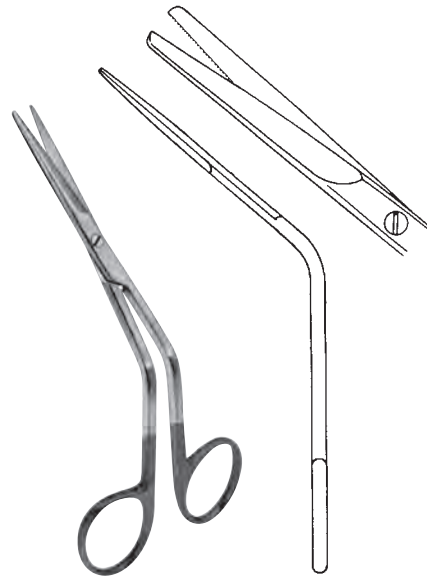

FOMON
012-893-145 14,5 cm, 5 3/4"

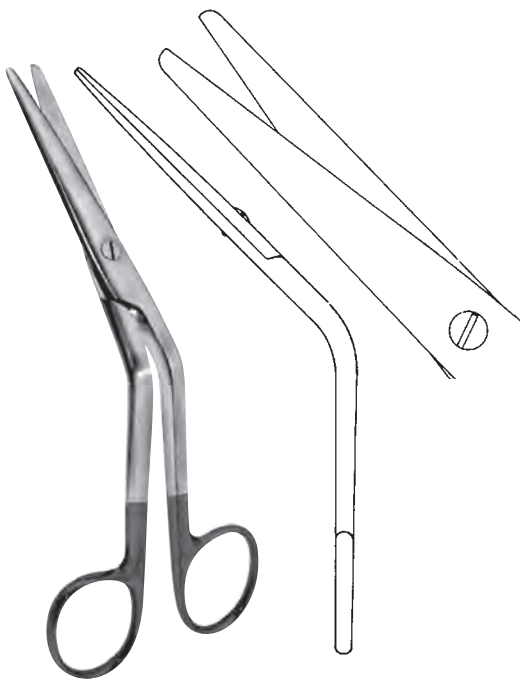

COTTLE
012-895-140 14,0 cm, 5 1/2"



HEYMANN
012-897-130 13,0 cm, 5 1/8"

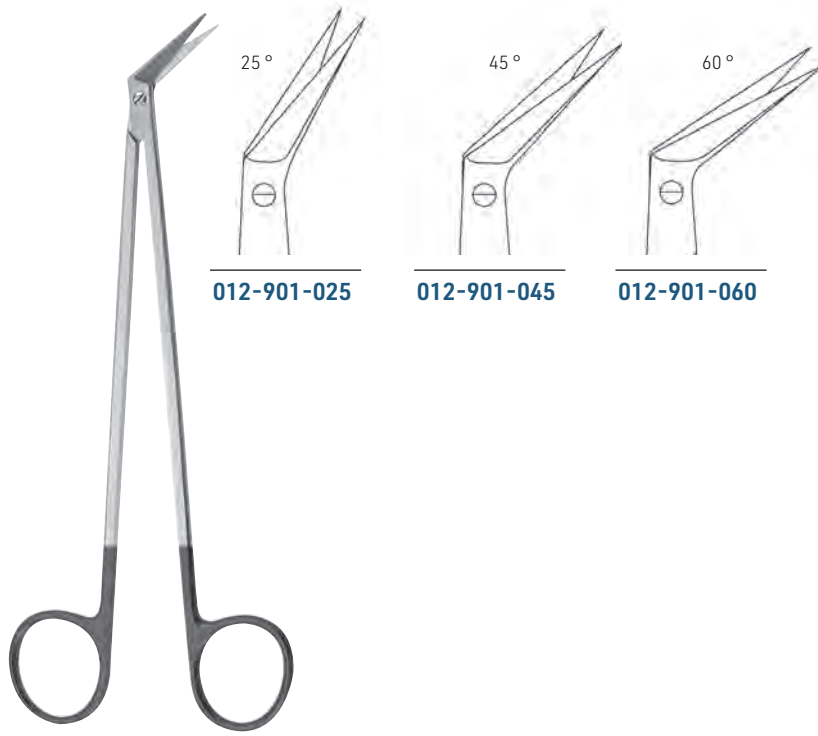

POTTS-SMITH

012-901-025 - 012-901-060 19,0 cm / 7 1/2"

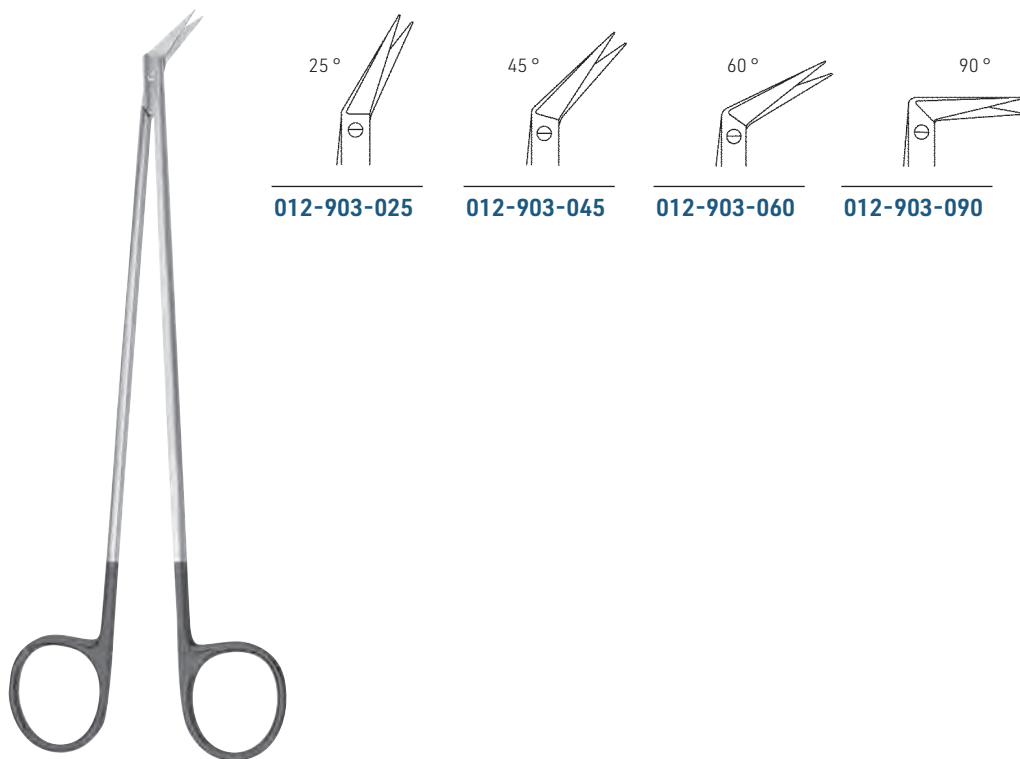

DIETRICH



012

Super-Cut Scheren
Super-Cut Scissors
Tijeras Super-Cut
Forbici Super-Cut

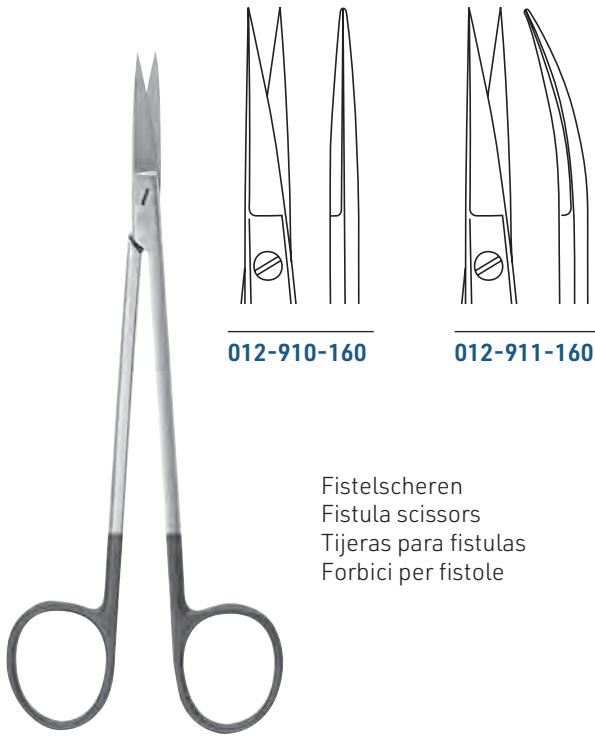

012-910-160

012-911-160

Fistelscheren
Fistula scissors
Tijeras para fistulas
Forbici per fistole

KELLY

012-910-160 - 012-911-160 16,0 cm / 6 1/4"



012-912-140

012-913-140

JOSEPH

012-912-140 - 012-913-140 14,0 cm, 5 1/2"



012-914-115

012-915-115

IRIS

012-914-115 - 012-915-115 11,5 cm / 4 1/2"

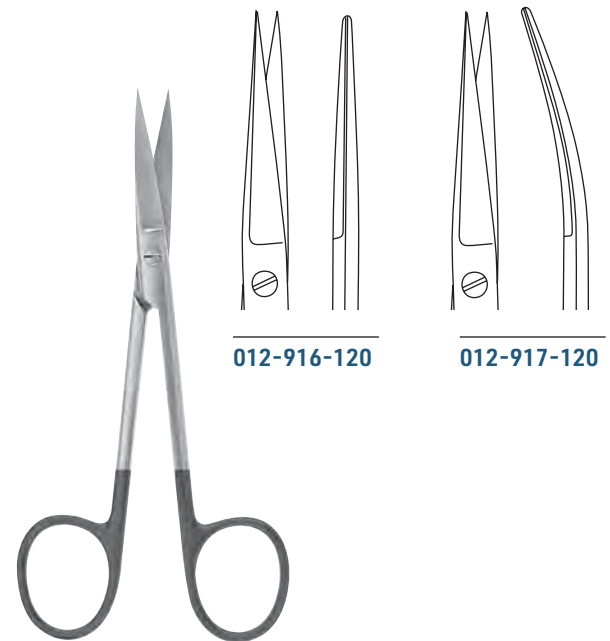

012-916-120

012-917-120

WAGNER

012-916-120 - 012-917-120 12,0 cm / 4 3/4"

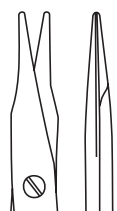

012-920-115



012-921-115

STEVENS

012-920-115 - 012-921-115

11,5 cm / 4 1/2"



012-922-130



012-923-130

GOLDMANN-FOX

012-922-130 - 012-923-130

13,0 cm / 5 1/8"



012-924-150



012-925-150

REYNOLDS

012-924-150 - 012-925-150

15,0 cm / 6"

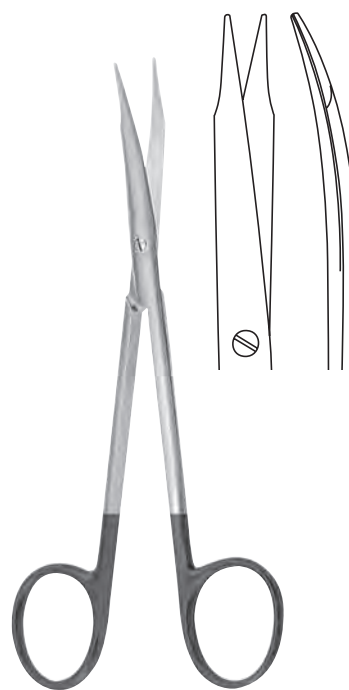

REYNOLDS

012-925-175

17,5 cm / 7"



012

Super-Cut Scheren
Super-Cut Scissors
Tijeras Super-Cut
Forbici Super-Cut

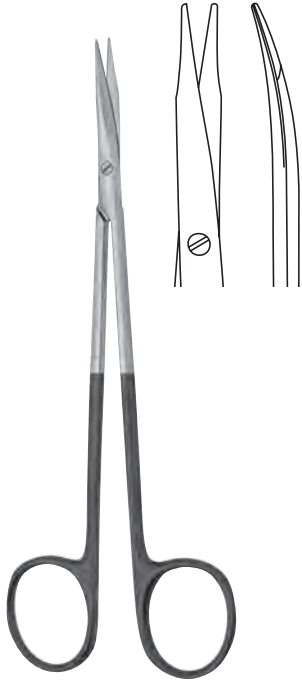

JAMESON

012-927-150 15,0 cm / 6"



012-930-120

012-931-120

PAR-TYPE

012-930-120 - 012-931-120 12,0 cm / 4³/₄"



KAYE FACE LIFT

012-933-150 15,0 cm / 6"

012-933-190 19,0 cm / 7¹/₂"



012-934-190

012-935-190

GORNEY

012-934-190 - 012-935-190 19,0 cm / 7¹/₂"

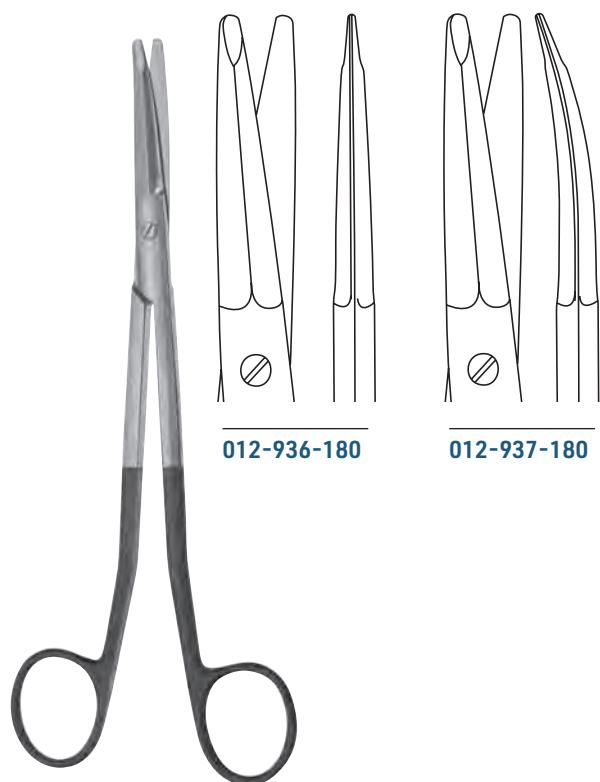

012-936-180

012-937-180

FREEMANN-KAYE

012-936-180 - 012-937-180 18,0 cm / 7"

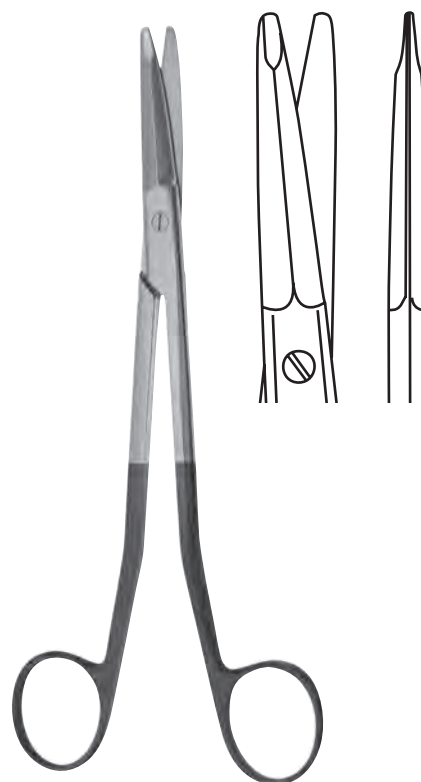

FREEMANN-GORNEY

012-938-190 19,0 cm / 7 1/2"
 012-938-230 23,0 cm / 9"

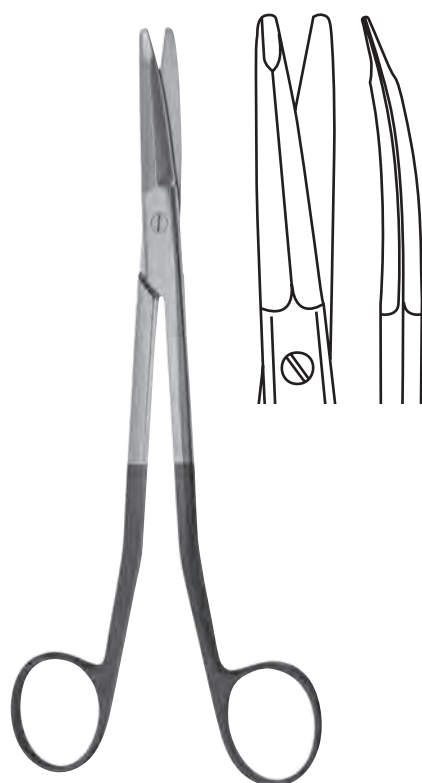

FREEMANN-GORNEY

012-939-190 19,0 cm / 7 1/2"
 012-939-230 23,0 cm / 9"

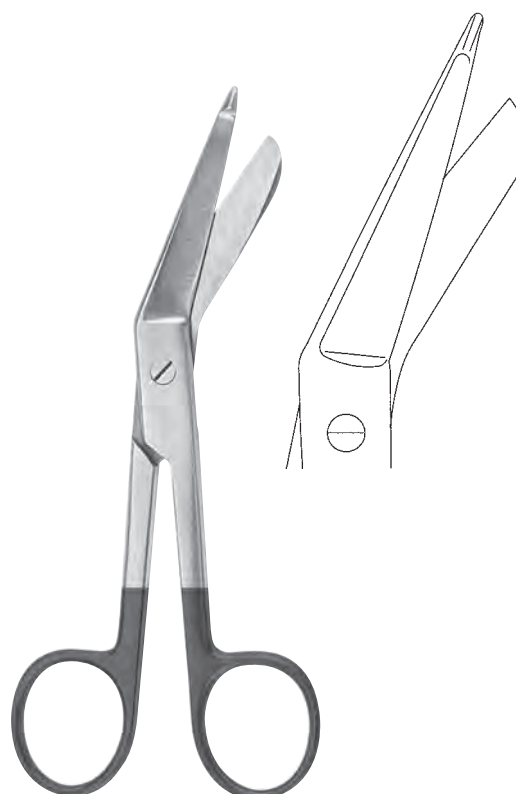

LISTER

012-951-140 14,0 cm / 5 1/2"
 012-951-180 18,0 cm / 7"