

CORNEA 550









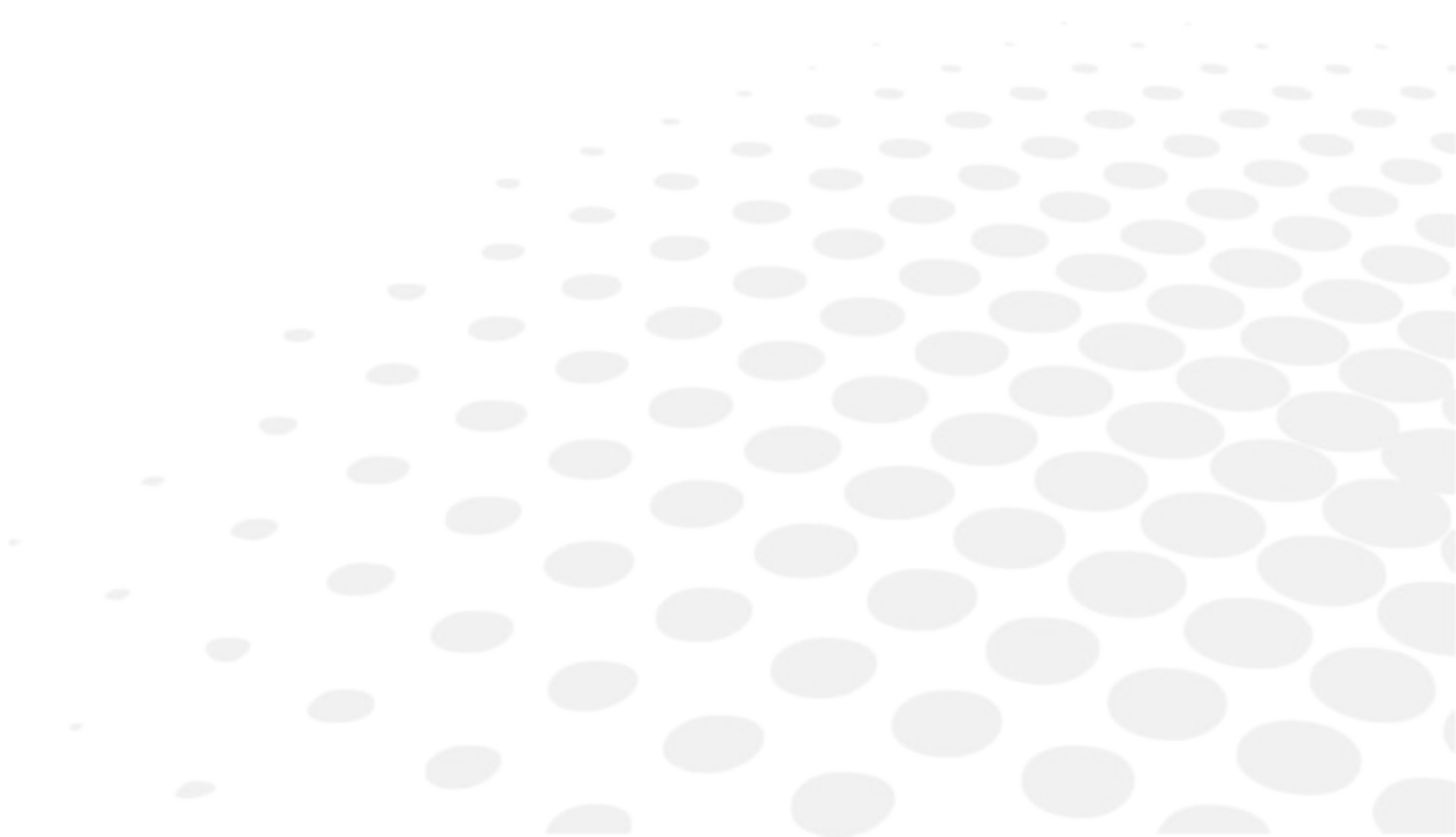

User manual

CONTENTS

I. INTRODUCTION	5
1. General warnings	7
2. Symbols marked on the instrument	8
a. Symbols marked on the instrument's packaging	8
3. Intended use and operating procedures	9
a. Classification	10
b. Environmental conditions	11
c. Warranty	11
4. Safety precautions	12
5. Disposal at the end of life	13
II. SUPPLY PACKAGE	15
1. Parts identification	17
III. ROUTINE MAINTENANCE	19
IV. USAGE	21
V. TECHNICAL FEATURES	25
VI. GUIDANCE AND MANUFACTURER'S DECLARATION	27
1. Electromagnetic emission	28
2. Electromagnetic immunity	28
VII. APPENDIX	31

I. INTRODUCTION



	The complete user manual is available on a web space. To access, please scan the QR code below using a dedicated application.
	Le manuel utilisateur complet est disponible sur un espace web. Pour y accéder veuillez scanner le QR code ci-dessous à l'aide d'une application dédiée.
	Die vollständige Bedienungsanleitung ist auf einem Speicherplatz verfügbar: Für den Zugriff darauf scannen Sie bitte untenstehenden QR-Code mittels einer dafür vorgesehenen Anwendung.
	El manual de uso completo está disponible en la web. Para acceder, escanee el código QR que se encuentra a continuación con la ayuda de una aplicación.
	De volledige gebruikershandleiding is beschikbaar op een website. U kunt de handleiding bereiken door de QR-code hiernaast te scannen met een geschikte applicatie.
	Den komplette brukerhåndboken er tilgjengelig på et webområde. For å få tilgang, må du skanne QR-koden nedenfor ved hjelp av en dedikert applikasjon.
	O manual do usuário completo está disponível na área web do cliente. Para acessar, scaneie o código QR abaixo usando a respectiva aplicação.



1. GENERAL WARNINGS

These instructions describe how to use the CORNEA550 and CORNEA550E Corneal Topographic Systems correctly. Only the marking and aesthetic change between these two products. Following the manual speak to simplify CORNEA550.









Warning

	Please carefully read this manual before using the device.
---	--









Our products are manufactured with maximum focus on reliability and safety. In order to use it efficiently and in complete safety we recommend reading this manual carefully before installation and use and heeding all the safety warnings contained in herein and reported on the exterior of the equipment. Even operators who have already used this type of instrument should verify their knowledge of the instructions contained in this manual. Keep this manual near the instrument for handy reference during use.

The original text of this manual is in Italian.

2. SYMBOLS MARKED ON THE INSTRUMENT

	<p>WARNING</p> <p>Symbol to point out attention on further information written in the instruction for use of the device</p>
	<p>Applied parts classified as Type B in accordance with EN 60601-1 standard</p>
	<p>Refer to operation manual</p> <p>It means that, for safety reasons, you need to consult the instruction manual before using the device</p>
	<p>Fuse</p>
	<p>"CE marking" that attests to product compliance with European Union Directive 93/42/EEC (Medical Devices) and following amendments</p>
	<p>Indicates the obligation to collect and separate disposal of electrical and electronic equipment, at the end of their useful life, according to 2012/19/EU</p>
	<p>Date of manufacturing</p>
	<p>Manufacturer</p>
	<p>Class II device</p>

a. Symbols marked on the instrument's packaging

	<p>Indicates a medical device that needs to be protected from moisture</p>
	<p>Indicates the temperature limits to which the medical device can be safely exposed</p>
	<p>Indicates the hygrometry limits to which the medical device can be safely exposed</p>
	<p>Indicates the air pressure limits to which the medical device can be safely exposed</p>
	<p>Fragile</p>
	<p>Handle with care</p>
	<p>This side up – carton box orientation</p>
	<p>Do not use hook for handling</p>
	<p>Stacking limit</p>

3. INTENDED USE AND OPERATING PROCEDURES

The Corneal Topographer CORNEA550 is an electro medical system for the detection, capturing and digital processing of an image of the cornea, for ophthalmologic diagnosis by eye specialists.

This system is the result of a long research carried out by recognized professionals to bring new technology, quality and design together to the highest level. An absolute innovation in the field of topography, this device allows "live" shooting on the computer monitor. Thanks to the electronic control of operating functions and the broad operation distance (compared to other devices of the same type), this device eliminates image decentralisation and focusing errors, ensuring measurement accuracy and repeatability. In addition, the reduced brightness of placido's rings makes the exam comfortable for the patient thus guaranteeing ample pupil size.

The video keratoscope is composed of:

- Placido's disk with 24 rings
- High-resolution colour video camera (1024x960 pixel)
- Management and control software including cornea measurement (AnaEyes)

The software allows the following:

Corneal topography module

- Assisted manual acquisition
- Advanced ring editing system allowing editing edge position to guarantee proper reconstruction also on particularly distorted surfaces
- Available maps:
 - Sagittal curvature map
 - Tangential curvature map
 - Altimetry
 - Refractive power
 - Gaussian curvature map
- The software elaborates display pages and summaries to focus on different aspects of a patient's diagnosis

These include:

 - 4-map summary
 - Single map display page
 - Keratoconus summary
 - Advanced altimetry and Zernike's altimetric examination
 - Corneal wavefront examination including:
 - Editable pupil corneal wavefront examination summary with map of the most common aberrations
 - A visual quality summary with PSF, spot diagram, MTF and sight simulation for the wavefront examined
- Autofit to find the best contact lens based on corneal altimetry, on a database with over 50,000 lenses and possibility to customize a lens on the cornea by keying in description parameters and simulating the lens placing it in different locations or tilting it to simulate the blinking effect
- Instruments for follow-up monitoring such as:
 - 2 or 3 element differential maps
 - Comparison of up to 4 different maps

- A wide range of synthetic descriptors of corneal characteristics such as:
 - Sim-K to simulate fixed ophthalmoscope measurements (for the anterior surface)
 - Main corneal meridians in 3 mm, 5 mm and 7 mm areas
 - The flattest and steepest hemi meridians in 3 mm, 5 mm and 7 mm areas
 - Peripheral degrees
 - Pupil decentralization, pupillary radius and size of the corneal diameter
 - Keratorefractive indices calculated in the pupil area to evaluate patient's visual quality
 - Keratoconus screening index for diagnosis and follow-up

Pupillometry module

A pupillometry module completely integrated with topography enables:

- Pupillometry with scotopic light to determine pupil maximum extension and optic zone diameters for treatment settings
- Pupillometry with mesopic light (4 lux)
- Pupillometry with photopic light (50 lux)
- Dynamic pupillometry, starting with over 400 lux and switching off the light source so that the pupil can dilate to its maximum extension
- Evaluation of pupil decentralization from the corneal vertex for each of the conditions previously described and calculation of the pupil centre during dilation
- Apply the measurements previously listed to the calculation of the corneal wavefront and visualize the pupil in different conditions on the topographic map

Videokeratoscopy module

- Examination of the tear film with white light
- Examination of the tear film with fluorescein
- Break up time measurement
- Examination of tear layers
- Examination of rigid contact lens' adaptation with fluorescein

a. Classification

Medical device classification

Device classification in accordance with the rules set out in Annex IX of Directive 93/42/EC and subsequent amendments: Class I with measuring function.

This device is  0459 since march 2015. Its expected lifetime is 7 years.

Electromedical devices classification

- Type of protection against direct and indirect contact: Class I
- The only applied part is the headrest
- Applied parts: Type B.
- Degree of protection against humidity: common device (no protection against water seepage) IP20.
- Sterilization method: disinfectable device.
- Degree of protection when used with anaesthetics or flammable detergents: no protection.
- Conditions of use: continuous operation.
- Degree of electrical connection between the device and the patient: device with parts applied to the patient.

b. Environmental conditions

As long as the device is kept in its original packaging, it can be exposed to the following environmental conditions without being damaged, and for a maximum period of 15 weeks during shipping and storage:

Operation	<ul style="list-style-type: none"> • Temperature: +10 to +35°C • Humidity: 30 to 90% • Atmospheric pressure: 800 to 1060 hPa
Storage	<ul style="list-style-type: none"> • Temperature: -10 to +55°C • Humidity: 10 to 95% • Atmospheric pressure: 700 to 1060 hPa
Transportation	<ul style="list-style-type: none"> • Temperature: -40 to +70°C • Humidity: 10 to 95% • Atmospheric pressure: 500 to 1060 hPa
Vibration	<ul style="list-style-type: none"> • Sinewave: 10Hz to 500Hz 0.5g • Shock 30g. Time: 6ms • Bump 10g. Time: 6ms

c. Warranty

The manufacturer is responsible for compliance with Directive 93/42/EC as amended by 2007/47/EE, its performance, safety and reliability, and the CE marking.

Device lifetime: 7 years, nevertheless manufacturer denies such responsibility when:

- The installation and commissioning are not made in accordance with the instructions and precautions given in this manual
- The device is not used in accordance with the instructions and precautions in this manual
- Spare parts and accessories not supplied or recommended by manufacturer are used
- Repairs and safety checks are not carried out by competent personnel, qualified, trained and authorized by manufacturer
- The electrical installation of the room in which the appliance is not in compliance with IEC and laws and regulations

Manufacturer disclaims any liability for direct or indirect consequences or damages to persons or property, resulting from improper use or incorrect clinical evaluation of its use.

Parts subject to wear and/or deterioration in normal and parts damaged by improper use or maintenance performed by persons not authorized by manufacturer are not covered by this warranty.

To request technical assistance with maintenance, please contact directly your local technical center or your distributor.

4. SAFETY PRECAUTIONS

- Do not touch the computer mains power cable with wet hands. Make sure the mains power cable is not walked on or trapped under weights. Do not tie the mains power cable.
- The power source must have a differential circuit breaker ($I\Delta n = 30 \text{ mA}$) and a thermal magnetic circuit breaker ($V_n = 230\text{V}$) to protect the device. The power socket must be close and easily accessible.
- A damaged power cable can cause fire or electric shock. It must be checked frequently. If the supplied computer power cable needs to be replaced, please contact the supplier.
- Do not attempt to carry out any technical intervention on the device or on the system unless specified in this manual.
- NEver attempt to modify or disassemble the device yourself.
- Do not use the device in the proximity of water and avoid liquid spillage on any surface of the device. Avoid humid or dusty places or places which are subject to rapid fluctuations in temperature and humidity.
- Unplug the device from the power socket before cleaning and/or disinfecting.
- The device does not generate or receive electromagnetic interferences when operated near other devices. No preventive or corrective action is necessary.
- No precautions are necessary in case of any changes affecting the device performance.
- In addition to the image capturing system, the device includes non electromedical appliances (personal computer, monitor, etc.). The resulting system is in any case tested in accordance with EN 60601:1 standards. Since the unit in question can include other instruments, medical electrical or not, manufacturer is unable to test compliance of all possible configurations.
- The configuration verified by manufacturer is the one with the personal computer outside of the patient's area.
- Any peripheral device (printer, scanner, CD player, etc) connected to the analogical or digital interface of the system must comply with the following standards:
 - EN: 60950-1 for ITE equipment (safety standards for information technology equipment) or ;
 - EN 60601:1 for medical electrical equipment. The peripheral devices must be connected outside of the patient's area.
- After connecting all the peripheral devices, the user is responsible for regularly verifying compliance of the electromedical system with EN 60601:1 standards (the specific requirements are reported in chapter 16 of the standards).
- Excessive light energy provided by infrared diodes can damage the patient's retina.

The device and all peripheral devices should be placed outside the patient area.

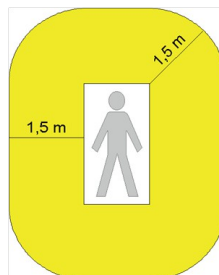

The patient area is the volume defined as shown in the figure, within which the patient may come into contact (intentionally or unintentionally, directly or through contact with the operators) with medical electrical and other devices making up the system.

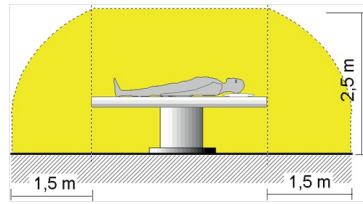

- If leakage current values exceed regulatory limits, further safety measures must be adopted, as indicated in the EN 60601:1 standards (3rd edition). In this case, the overall system must be powered through an adequate separator or isolation transformer.
- The transformer is absolutely necessary in case the operators cannot easily keep the computer and other non-electromedical appliances outside of the patients' area.

Warning



Only units with manufacturer trademark can be placed and used in the patient's area. The following parts of the system must instead be placed outside the patient's area:

- Computer (desktop or laptop), with any peripheral device (monitor, keyboard, mouse, etc.)
- Printers
- Other non-electromedical auxiliary devices (supply units/battery chargers, UPS, modem, etc.)

If the system needs to be connected to a computer network (LAN) all the necessary measures must be adopted to prevent transfer of dangerous voltage from remote stations, through the connected cables. The use of data transfer devices ensuring "GALVANIC ISOLATION" may be necessary.



Manufacturer shall not be held liable in relation to the patient and operator's safety in the case of electrical connections between the computer and other external units (peripherals) or LAN networks which are not made by the manufacturer itself.

5. DISPOSAL AT THE END OF LIFE

According to directives 2012/19/UE WEEE and 2011/65/UE RoHS II on the restriction of hazardous substances in electrical and electronic equipment and on their disposal.

Public authorities adopt adequate measures to make sure that users, distributors and manufacturers contribute to the collection of electrical and electronic equipment, setting legal requirements for reusing, recovering or recycling said equipment.

The device purchased has been manufactured using special materials and substances. The device may contain hazardous substances potentially harmful to the environment or to human health if improperly disposed of into the environment.

Warning

	<p>The user must take into account the potentially harmful effects to the environment or human health due the improper disposal of the equipment or of parts of it.</p>
---	---

To prevent the release of hazardous substances into the environment and to promote conservation of natural resources, the manufacturer, in case the user wishes to dispose of the device used at the end of its useful life, facilitates the possibility of its reuse and the recovery and recycling of the materials contained therein.

	<p>The graphic symbol shown in the figure is applied on the equipment's label. It reminds that all electrical and electronic equipment must be collected and disposed of separately at their end-of-life.</p>
---	--

In the case of disposal of the device, specific provisions of European and national law apply, and provide that:

- The device shall not be disposed of as urban waste, it shall be collected separately, by contacting a company specializing in the disposal of electrical/electronic equipment or the public authorities responsible for waste management.
- In the event that a new piece of equipment is purchased from the same manufacturer to replace an old one placed on the market before 13 August 2005, equivalent and with the same functions of the new equipment, the distributor or manufacturer is legally required to collect the old piece of equipment.
- If the user wants to get rid of a used piece of equipment, placed on the market after 13 August 2005, the distributor or manufacturer is legally required to collect it.
- By joining the specific technological waste disposal consortium, the manufacturer shall take care of the handling, recovery and/or disposal of the old equipment collected, at its own charge.

The manufacturer will provide the users with any information regarding the hazardous substances contained in the device and on the recovery and recycling of said substances, as well as on the possible reuse of the used device.

Violations shall be punished by the current legislation with serious administrative sanctions.

II. SUPPLY PACKAGE

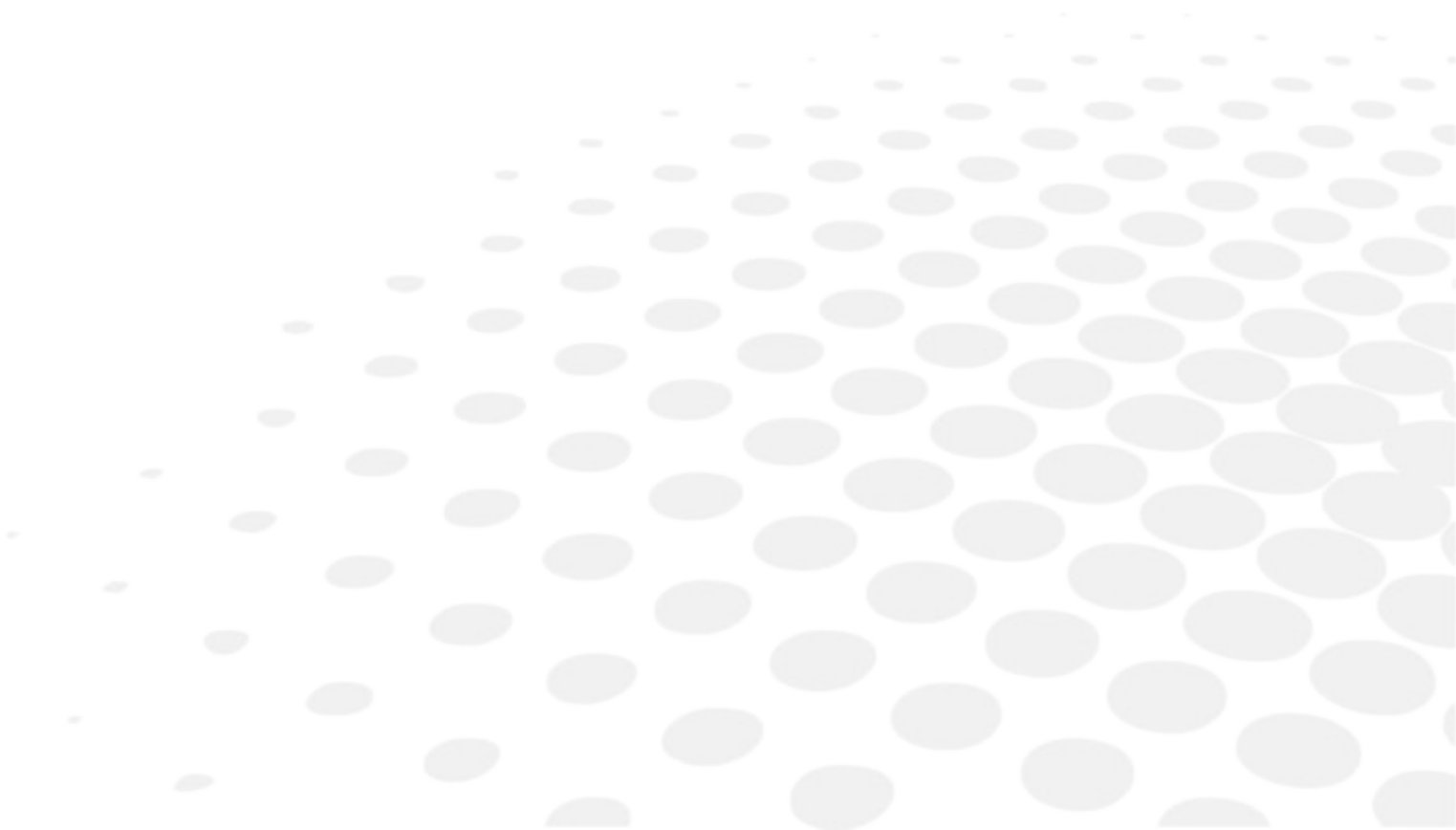

The system is composed of the following main units:

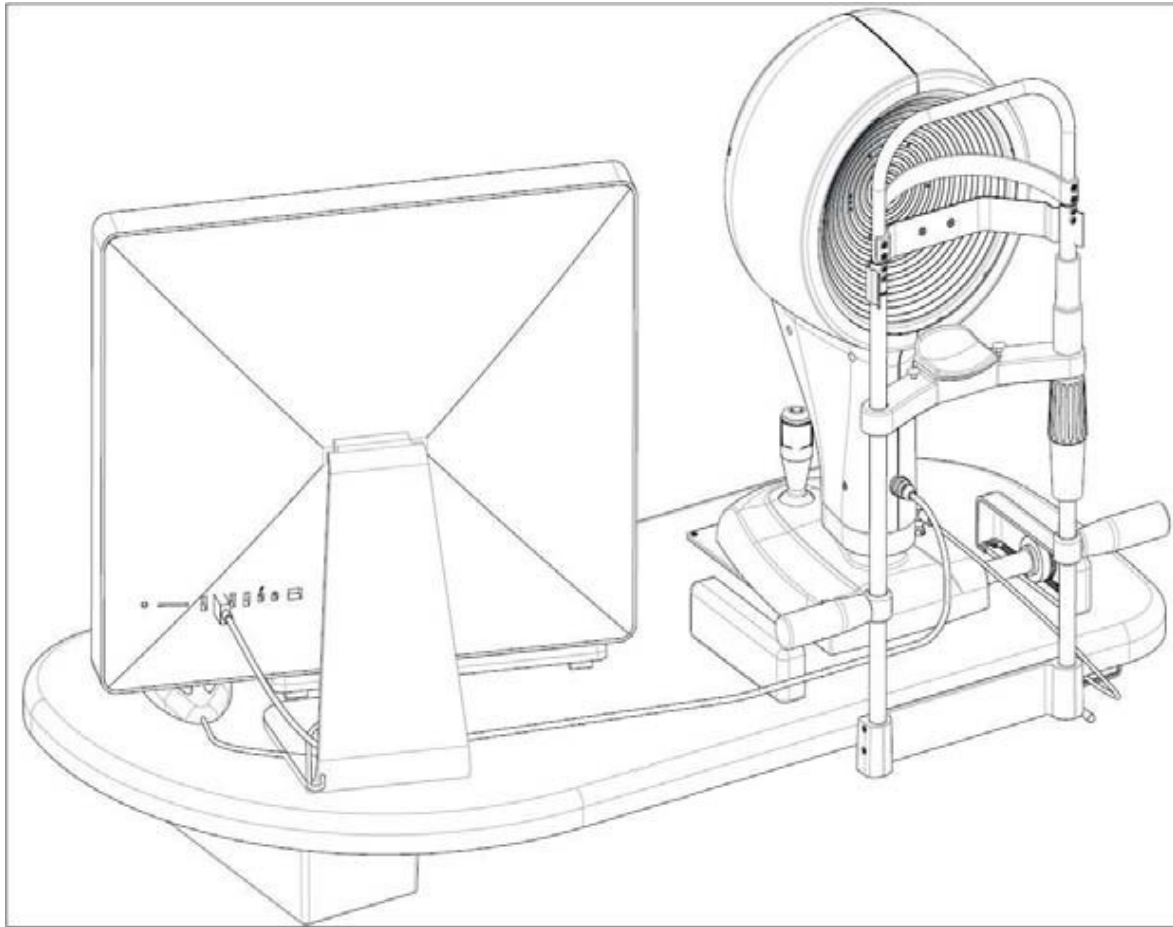

Topographic unit, designed and manufactured by ESSILOR, composed of:

1. Keratoscope
2. External power supply unit:
 - INPUT : 100-240Vac 50/60Hz 0,9A
 - OUTPUT : 24Vdc - 2A
3. AnaEyes software

The system is supplied with the following accessories:

- Two guards for the slide guides
- One protection cover
- One set of Allen wrenches
- One set of chinrest papers
- Two fuses
- One calibration set
- Chinrest

Optional

- Table top
- Elevating lift
- Sliding kit for table top
- Computer

1. PARTS IDENTIFICATION

	<ul style="list-style-type: none"> 1. Instrument with Placido's disk 2. Joystick with capturing trigger button 3. Guiding slides guards 4. Optical switching switch 5. Power lamp 6. Optical switching 7. Geared guides 8. Output 9. Geared wheels 10. Chinrest support 11. Patient's handle 12. Chinrest 13. Headrest 14. Chinrest module 15. Calibration set
--	---

	<ul style="list-style-type: none"> 16. Instrument power supply cable 17. Optical switching data nameplate 18. Mains supply cable
--	---

	<ul style="list-style-type: none"> 19. IR LED 20. Blue LED 21. USB3 cable 22. Locking knob 23. Capturing channel 24. Placido's disk
--	---

III. ROUTINE MAINTENANCE

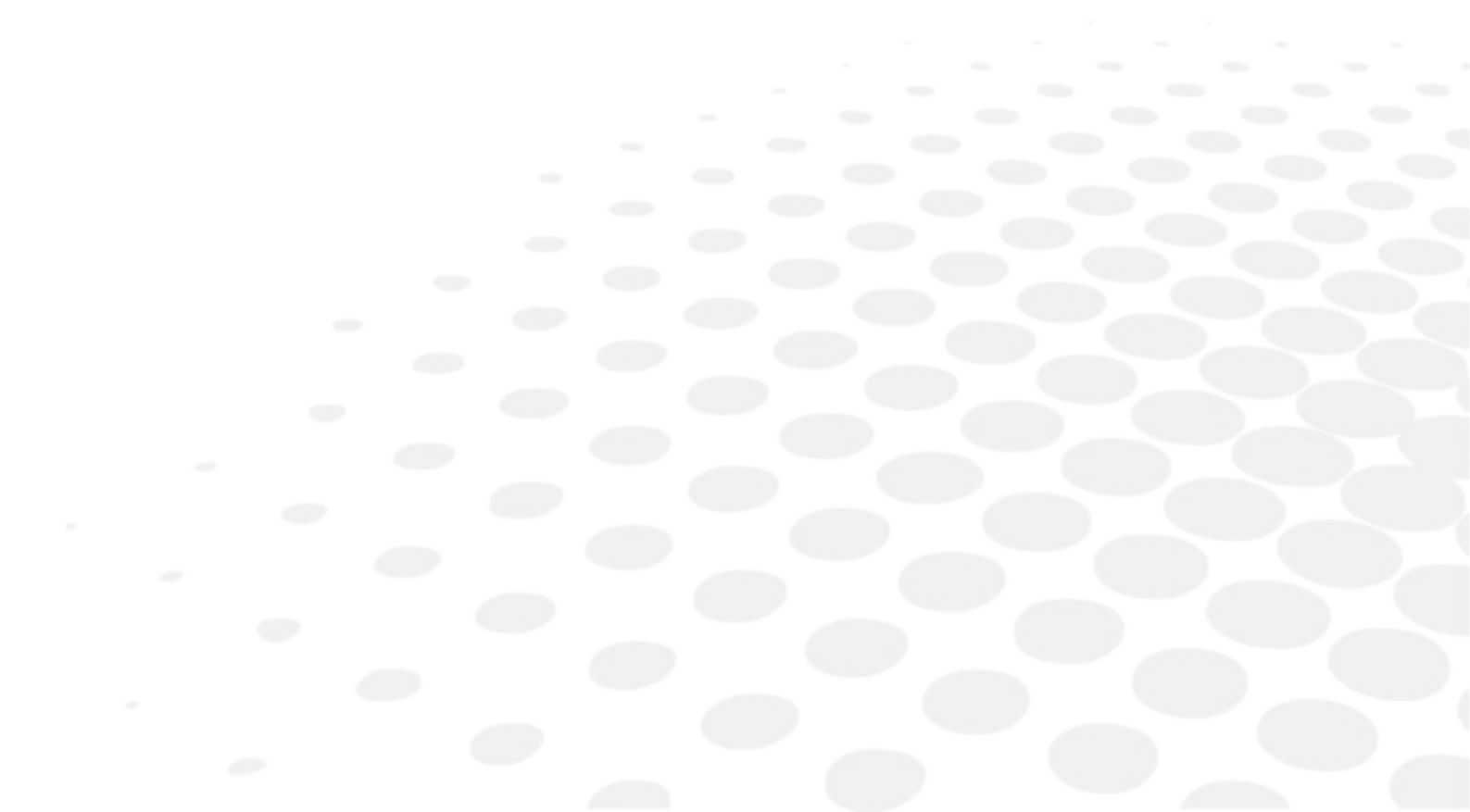

The system does not require any particular routine maintenance operations by the user. To clean the external surfaces simply use a cloth slightly dampened with water.

Use the paper to cover the chinrest after each patient use.

Protection against dust

When not in use, protect the system against dust. Dust accumulating on the device must be regularly removed with a soft cloth or blower.

Other maintenance operations (repairs, components replacement, assessment of internal components, etc.) fall within the exclusive competence of the manufacturer technical assistance service.

Warning

	<p>Do not use any thinners or solvents.</p> <p>If the product needs maintenance, contact the technical service authorized by the manufacturer.</p>
---	--

IV. USAGE

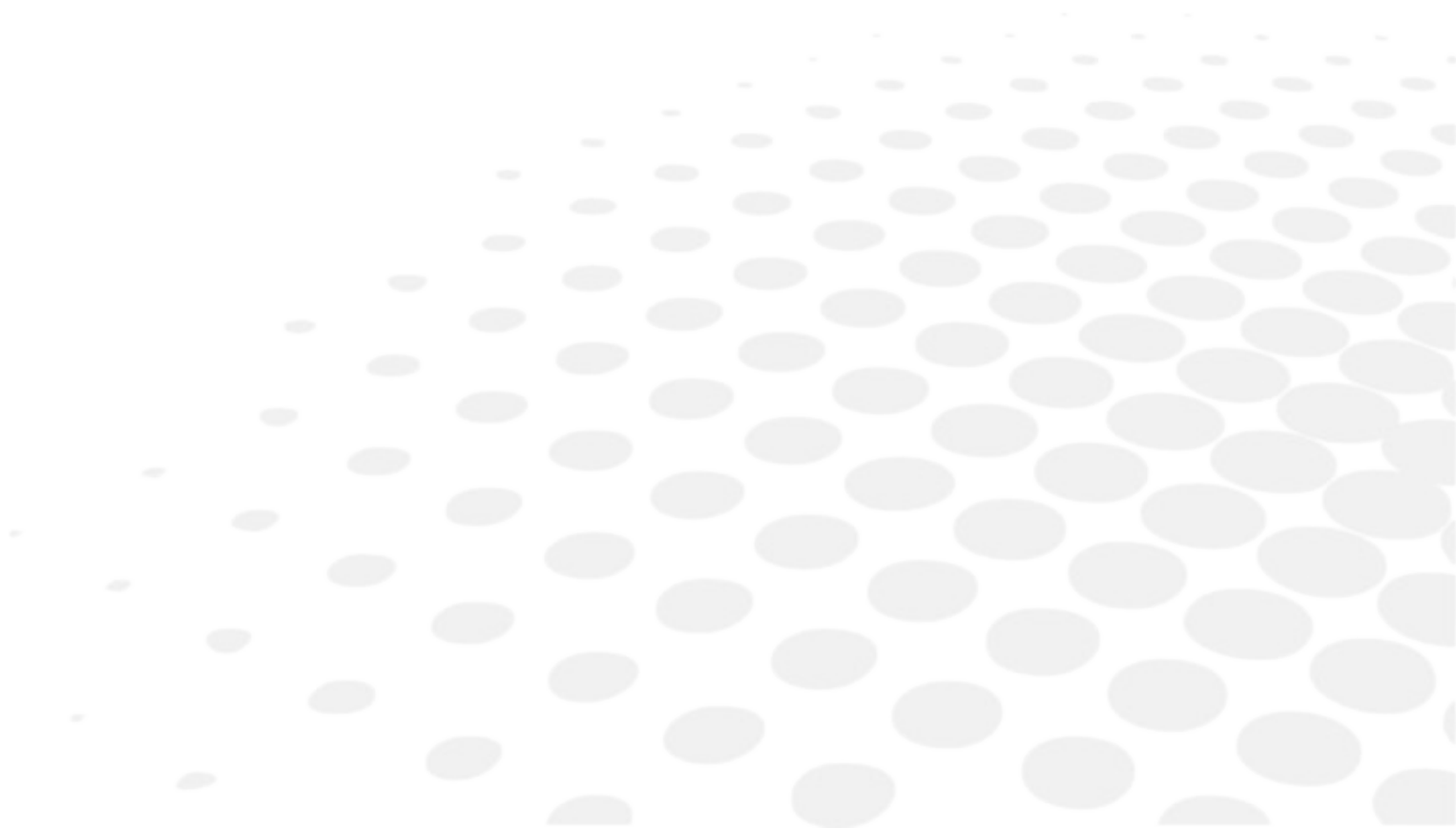

The user has evaluation criteria based on his experience that allows him to critically analyze the software.

Keratotomy

- 1 Have the patient comfortably sit down with his/her chin on the chinrest and the forehead against the forehead rest.
- 2 Lift and lower the chinrest using the handle to align the patient's eyes with the central eyepiece of the instrument.
- 3 Enter the AnaEyes software.

To use the corneal topographer follow the main instructions below:

- Press the "NEW PATIENT" button and key in "FIRST NAME" and "LAST NAME" (if the patient is already in the database you can launch an automatic query by last or fictive name).
- Key in the "BIRTHDATE" and click "SAVE".
- Key in the "BIRTHDATE" (these data are compulsory and required by the management software).
- Choose the exam mode among "KERATOTOMY", "VIDEOKERATOTOMY", "PUPILLOGRAPHY", "MEIBOGRAPHY", "TEAR FILM".

- 4 Move onto the instrument.

Move the joystick to centre the eye on the display, refocus placing the joystick perpendicular to the table.

Now pull the joystick completely back towards you, then press and hold the button while pushing the joystick towards the patient.

> The capturing will be automatically completed with a focused image.

> More images are captured consecutively.

- 5 Select the images to preview.

- 6 Double-click on each individual image to save the best images.

- 7 Exit the capturing window to save the images to the gallery.

- 8 Double-click on the selected image in the gallery to enter the image processing environment.



If necessary, edit the rings in the ring editing menu.



If necessary, edit the pupil size in the pupil editing menu.



If necessary, edit the limbus size in the limbus editing menu.

9 Click "OK" to save any changes made.

> At this point, the exam is complete.



Please refer to the software user manual for videokeratometry, pupillography, meibography, tear film modes.



For further information and access to all image elaborations, please refer to the user manual of AnaEyes.

Warning



- To avoid the risk of electric shock this device must only be connected to a power supply system with protective earthing.
- For isolation from the mains (condition of complete safety) the computer power cable must be disconnected.
- To turn off the system, simply follow the usual procedure to exit the software, then switch off the computer power switch.
- Do not switch off the computer or disconnect the cable between the computer and the topographer when the program is running.

V. TECHNICAL FEATURES

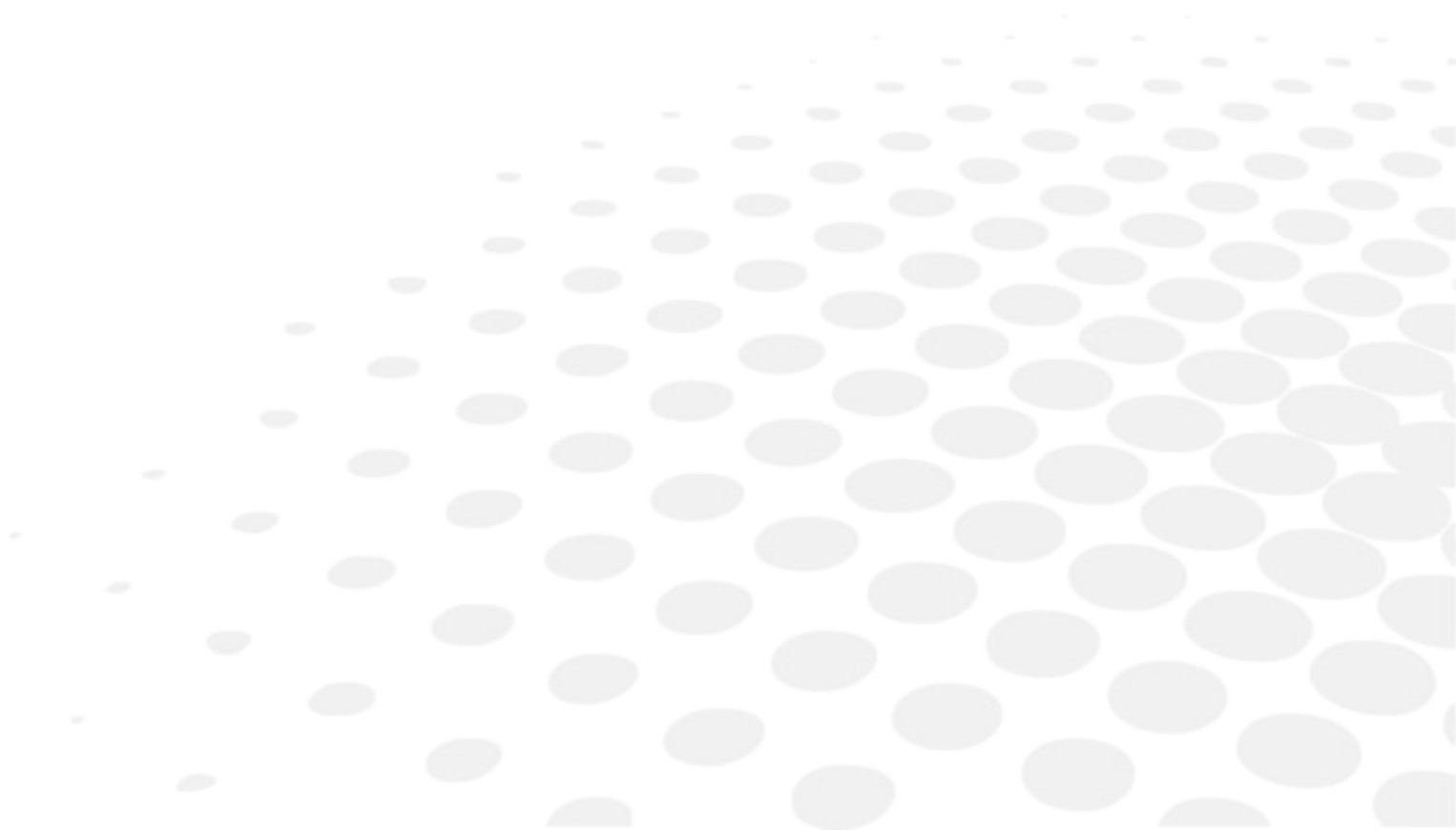

Operation distance	74 mm from corneal vertex
Number of rings	24
Number of measuring points	6144 (24x256)
Number of points analyzed	Over 100000
Diameter of the corneal area covered (at 43 D)	0.4 to over 9.6 mm of diameter
Dioptres measuring arc	1 to 100 D
Accuracy and repeatability error	Class "A" as per "ISO19980"
Power supply	Through 24V DC external power supply unit
Input power supply unit specifications	INPUT : 100-240Vac 50/60Hz 0,9A OUTPUT : 24Vdc - 2A
Power cable technical specifications	Four-core cable (three cores with earth), conductors minimum cross-section 1mm ²
Placido's LED lighting	White LED
Fluorescein LED lighting	Blue LED 460 nm
Pupillometry LED lighting	IR LED 875 nm
Weight	6.2 kg
Size (HxWxD) mm	505x315x251 mm
Computer connection	USB3 Type A cable

VI. GUIDANCE AND MANUFACTURER'S DECLARATION

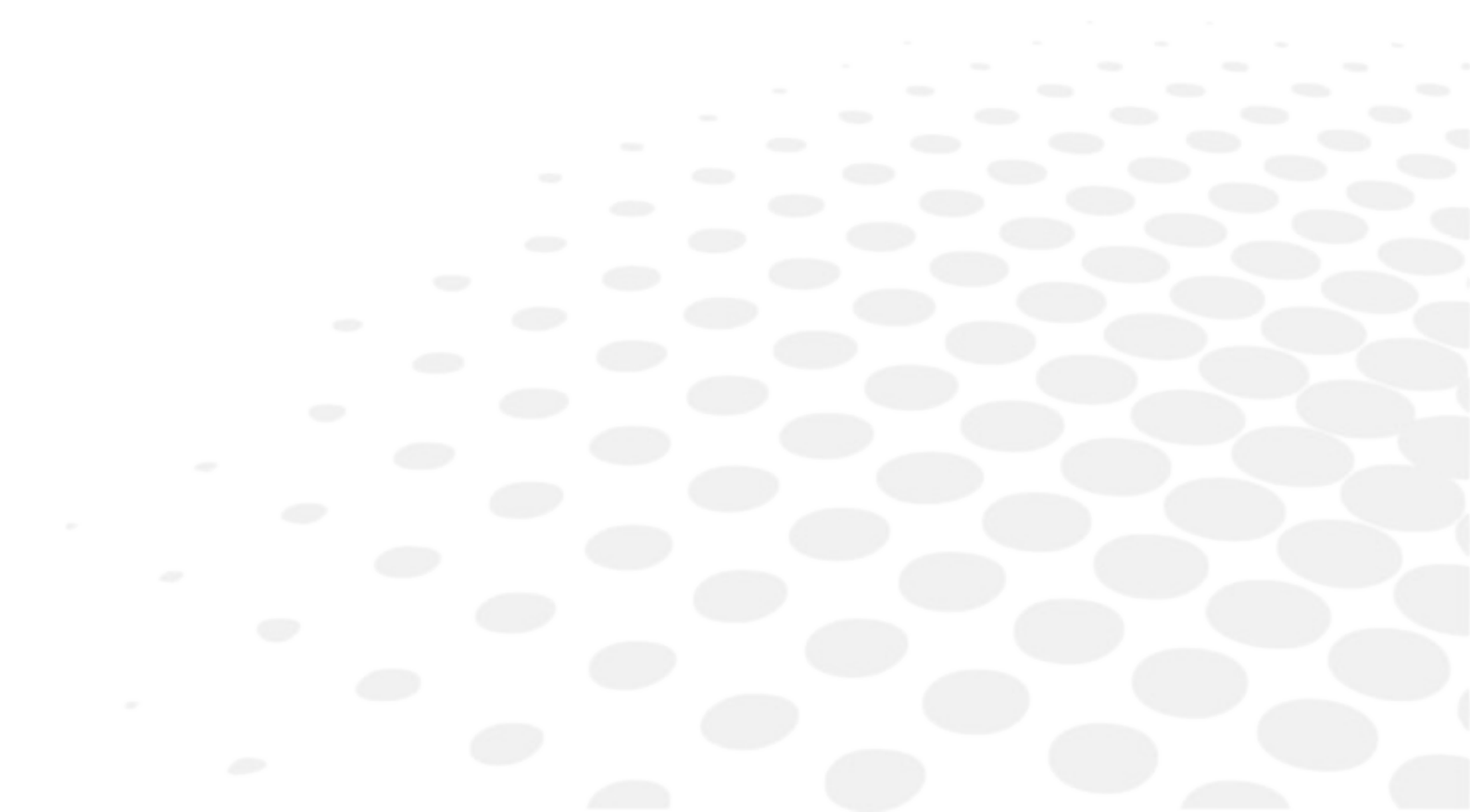

1. ELECTROMAGNETIC EMISSION

Guidance and manufacturer's declaration – electromagnetic emission

The equipment CORNEA550 is intended for use in the electromagnetic environment specified below.

The customer or the end user of the CORNEA550 should assure that it is used in such an environment.

Emission test	Compliance	Electromagnetic environment - guidance
RF emission – CISPR 11	Group 1	The CORNEA550 uses RF energy only for its internal function. Therefore its emissions are very low and are not likely to cause any interference in nearby electronic equipment.
RF emission – CISPR 11	Class B	The CORNEA550 is suitable for use in all establishments including domestic establishments and those directly connected to the public low voltage power supply network that supplies buildings used for domestic purposes.
Harmonic emission IEC 61000-3-2	Class A	
Voltage fluctuation/flicker emission IEC 61000-3-3	Complies	

2. ELECTROMAGNETIC IMMUNITY

Guidance and manufacturer's declaration – electromagnetic immunity			
The equipment CORNEA550 is intended for use in the electromagnetic environment specified below. The customer or the end user of the CORNEA550 should assure that it is used in such an environment.			
Immunity test	IEC 60601 Test level	Compliance level	Electromagnetic environment - guidance
Electrostatic discharge (ESD) IEC 61000-4-2	±6 kV contact ±8 kV air	±6 kV contact ±8 kV air	Floors should be wood, concrete or ceramic tile. If floors are covered with synthetic material, the relative humidity should be at least 30%.
Electrical Fast Transient/burst IEC 61000-4-4	±2 kV for power supply lines ±1 kV for I/O lines	±2 kV for power supply lines Not applicable	Mains power quality should be that of a typical commercial or hospital environment.
Surge IEC 61000-4-5	±1 kV differential mode ±2 kV common mode	±1 kV differential mode ±2 kV common mode	
Voltage dips, Short interruptions and voltage variations on power supply input lines IEC 61000-4-11	<5% U_T for 0,5 cycle 40% U_T for 5 cycles 70% U_T for 25 cycles <5% U_T for 5 sec	<5% U_T for 0,5 cycle 40% U_T for 5 cycles 70% U_T for 25 cycles <5% U_T for 5 sec	Mains power quality should be that of a typical commercial or hospital environment. If the user of the CORNEA550 requires continued operation during power mains interruptions, it is recommended that the CORNEA550 be powered from an uninterruptible power supply or battery.
Power frequency (50/60Hz) magnetic field IEC 61000-4-8	3 A/m	3 A/m	Power frequency magnetic fields should be at levels characteristic of a typical location in a typical commercial or hospital environment.
Note: U_T is the AC mains voltage prior to application of the test level.			

Guidance and manufacturer's declaration – electromagnetic immunity

The equipment CORNEA550 is intended for use in the electromagnetic environment specified below. The customer or the end user of the CORNEA550 should assure that it is used in such an environment.

Immunity test	IEC 60601 Test level	Compliance level	Electromagnetic environment - guidance
<p>Conducted RF IEC 61000-4- 6</p> <p>Radiated RF IEC 61000-4- 3</p>	<p>3 Vrms 150KHz to 80MHz 3V/m 80 MHz to 2,5 GHz</p>	<p>3 Vrms 3 V/m</p>	<p>Portable and mobile RF communication equipment should not be used close to any part of the CORNEA550, including cables. Recommended separation distance. $d=1,167*\sqrt{(P)}$ $d=1,167*\sqrt{(P)}$ 80 MHz to 800 MHz $d=2,333*\sqrt{(P)}$ 800 MHz to 2,5 GHz</p> <p>Where P is the maximum output power rating of the transmitter in watts (W) according to the transmitter manufacturer and (d) is the recommended separation distance in metres (m).</p> <p>Field strengths from fixed RF transmitters, as determined by an electromagnetic site survey, should be less than the compliance level in each frequency range.</p> <p>Interference may occur in the vicinity of equipment marked with the following symbol: </p>

Note 1: at 80 MHz and 800 MHz, the higher frequency range applies.

Note 2: These guidelines may not apply in all situations. Electromagnetic propagation is affected by absorption and reflection from structures, objects and people.

VII. APPENDIX

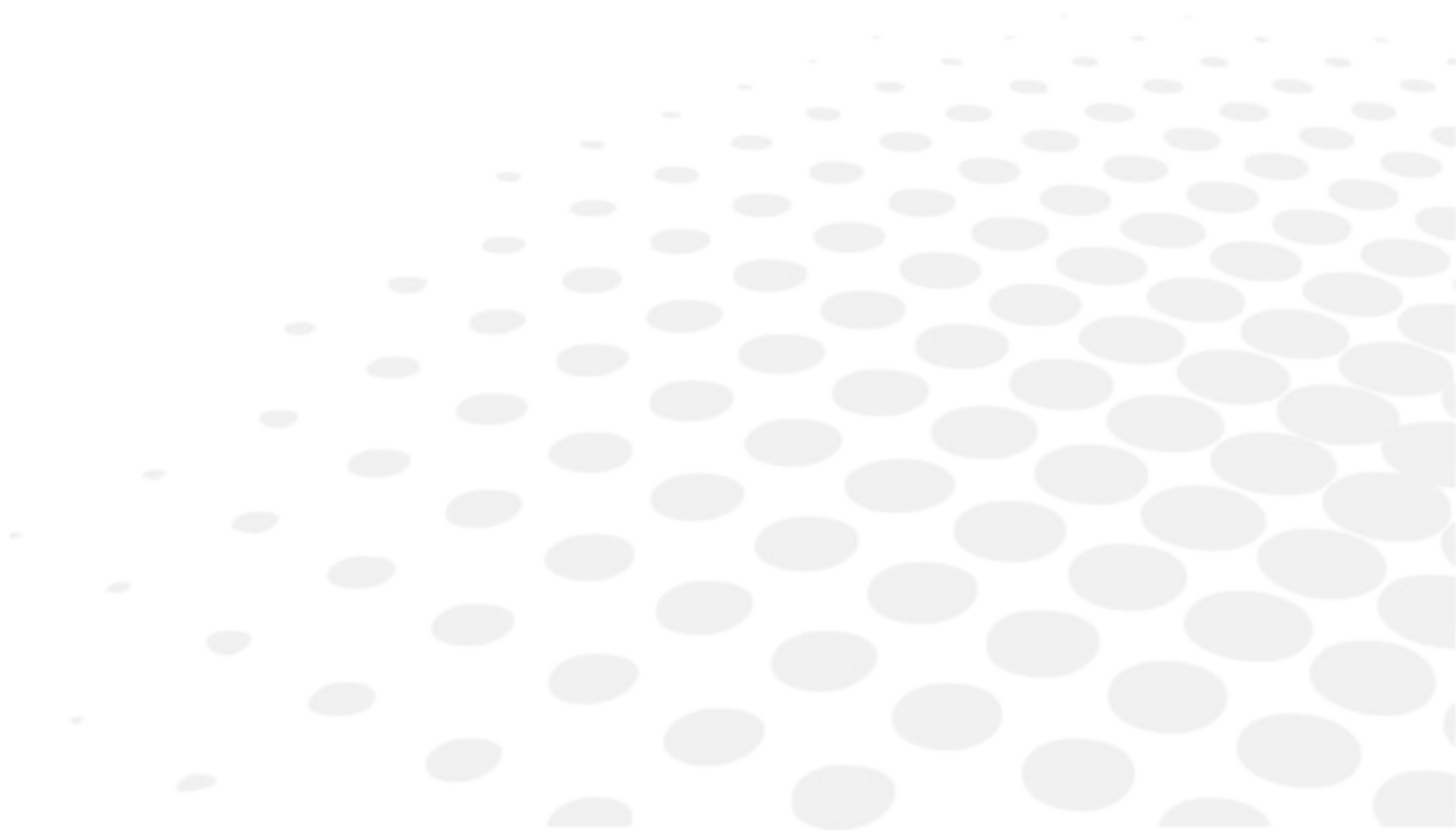

All equipment composing the system is always delivered packaged in optimal conditions to withstand standard transport and storage conditions. In the event that, when removing the device from its packaging, damages due to transport are detected, please contact the installer company or the manufacturer directly.

- Make sure the mains voltage matches the voltage indicated on the AC/DC adapter and on the computer. If the voltage does not match contact the technical service or the manufacturer.
- Do not use multiple sockets, adapters or extension cables to connect the device plug to the mains socket.
- To disconnect from the power supply, also in case of emergency, grab the plug of the power cable. Do not pull the power cable to unplug the device.

To assemble the device, follow the instructions below:

1. Secure the table top to a base. The instrument holder table is below the device ready for assembly proceed as follows:
 - Position the table on the base plate and insert the screws supplied.
 - Fix the top to the bottom by tightening the four socket head screws.
2. Unscrew the two socket head screws under the chinrest.
 - Insert the screws in the chinrest module and align its holes with the holes of the table top.
 - Tighten the screws with the wrench provided with the device.
3. Place the base with orthogonal movements on the slides on top of the instrument holder table.
 - Make sure the wheels are aligned.
 - Lock the device with the knob (22) on the right side of the base, above the wheels axis.
4. Fix the guards (3) along the slides by inserting the tags into their slots.
5. Connect the computer to the mains and switch on the computer.
6. If the AnaEyes software is not already installed, follow the instructions on the user manual supplied with the software to install it.
7. Make the following connections:
 - Connect the power supply unit to the mains with the cable (18).
 - Plug in the device power supply cable (16).
8. Turn on the power supply unit.
9. Connect the USB cable (21) to the computer.
10. The system is ready for use.

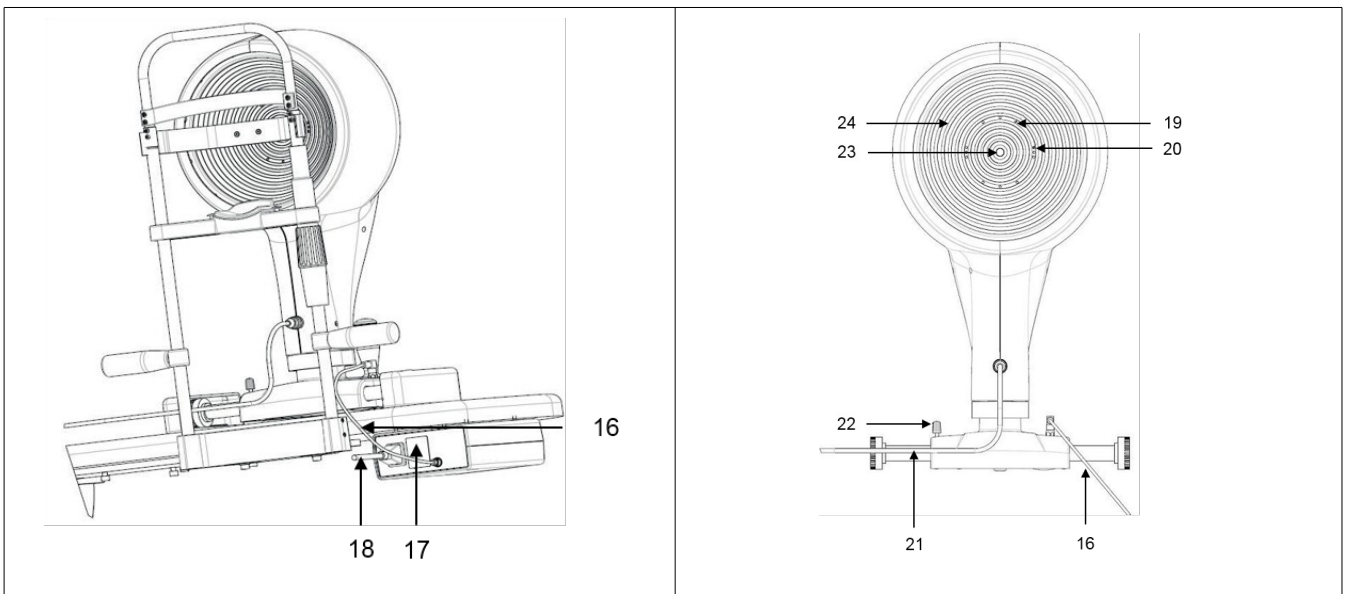
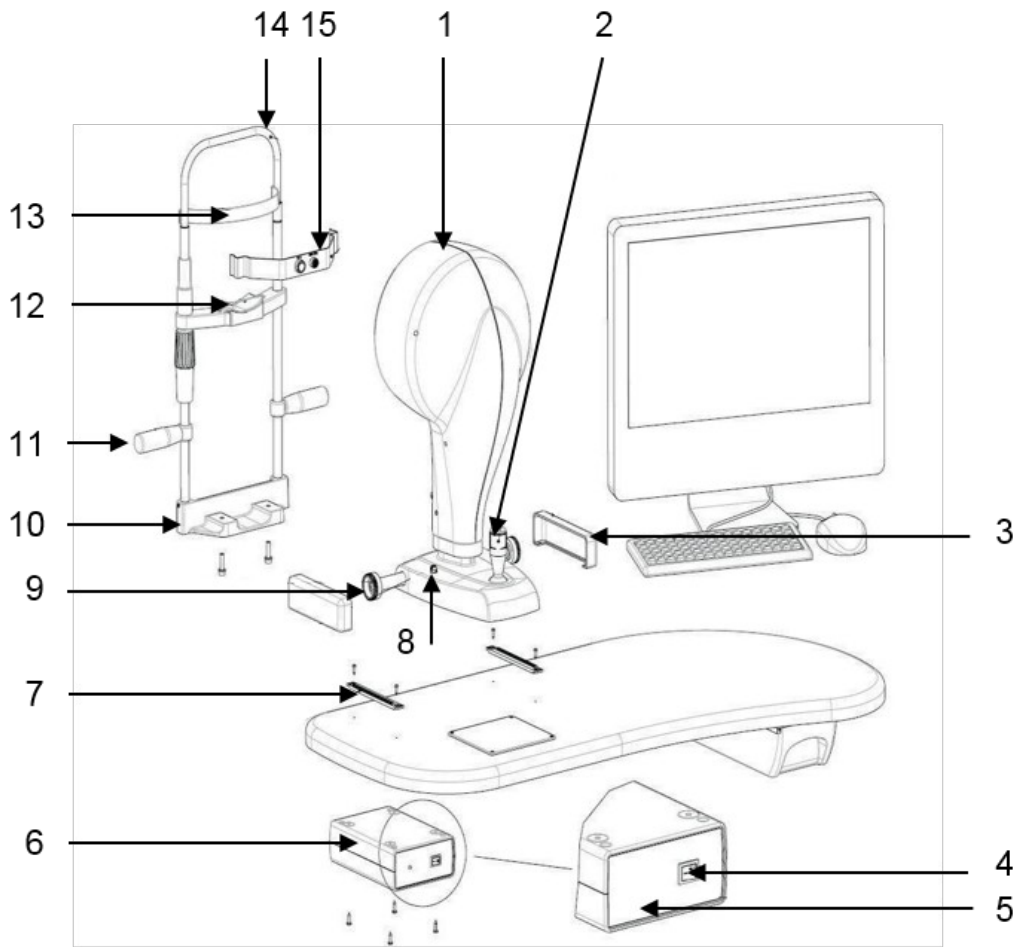



Essilor Instruments USA

8600 W. Catalpa Avenue, Suite 703

Chicago, IL 60656

Phone: 855.393.4647

Email: info@essilorinstrumentsusa.com

www.essilorinstrumentsusa.com